

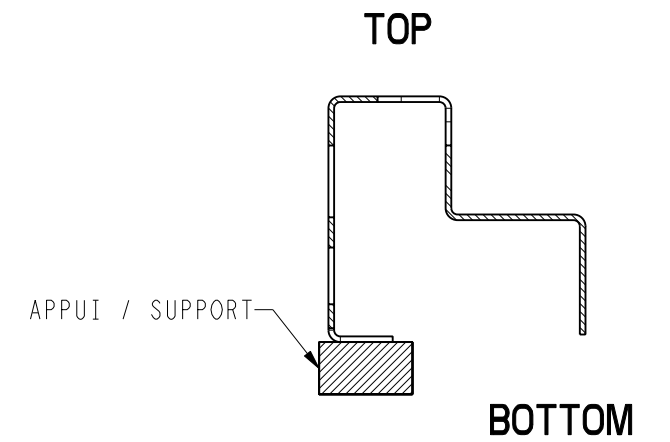

3V-STD

OPTION PLOTS ANTIVIBRATILS
ANTI-VIBRATION MOUNTS OPTION

LX 0808 / 0908 / 1008

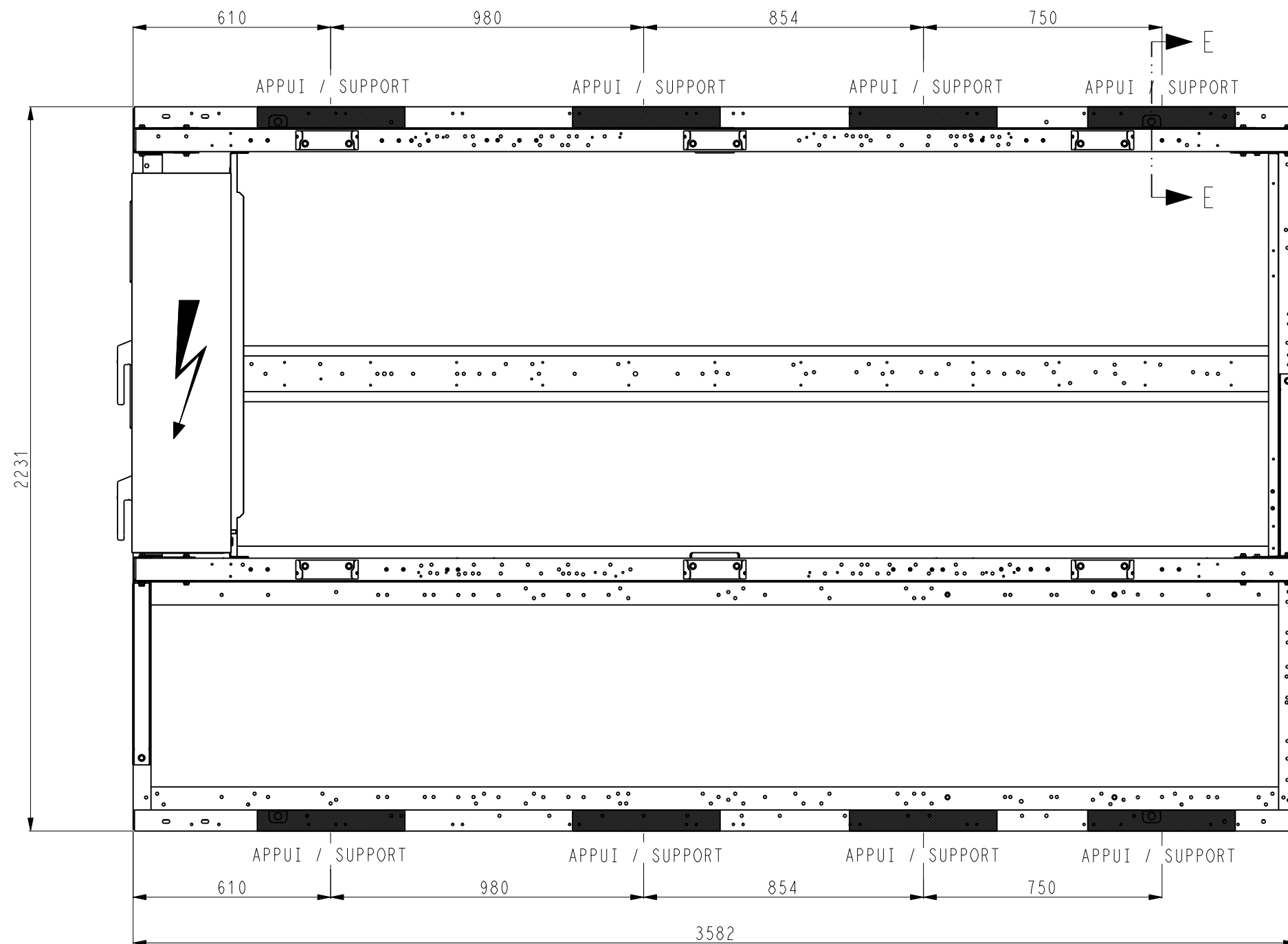

COUPE / SECTION E - E
ECHELLE 1:4

TOLERANCE	LX-UNIT		DATE	Feuille Sheet 1/12 Indice A
±10	*		03-May-18	
		00DCG000330700		

3V-OPT50

OPTION PLOTS ANTIVIBRATILS
ANTI-VIBRATION MOUNTS OPTION

LX 0808 / 0908 / 1008

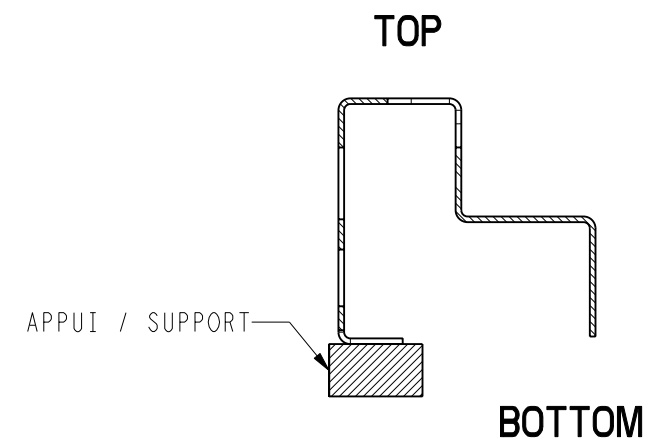
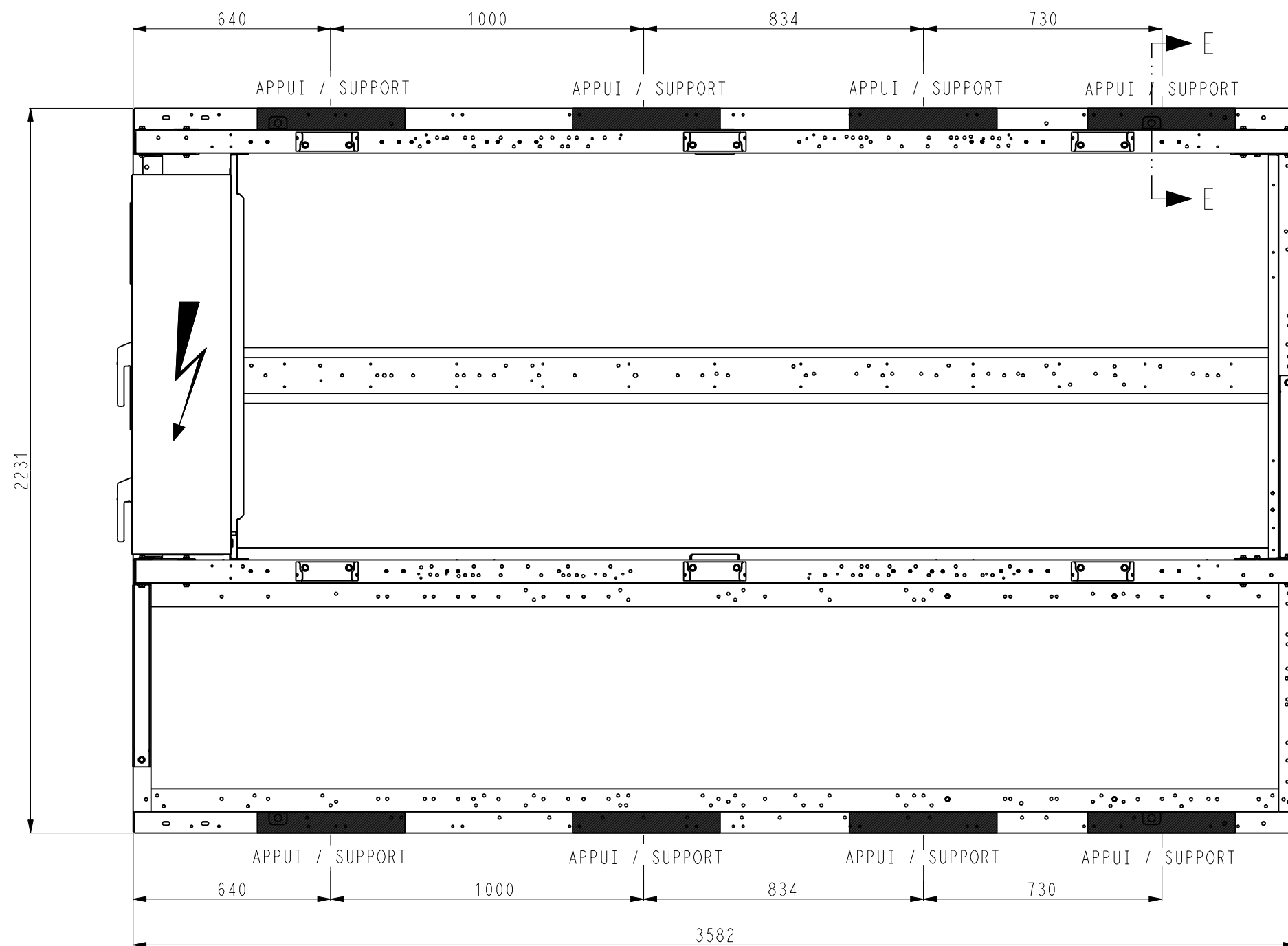

COUPE / SECTION E-E
ECHELLE 1:4

TOLERANCE	LX-UNIT		DATE	Feuille Sheet 2/12 Indice A
±10	*		03-May-18	
		00DCG000330700		

3V-OPT116x

OPTION PLOTS ANTIVIBRATILS
ANTI-VIBRATION MOUNTS OPTION

LX 0808 / 0908 / 1008

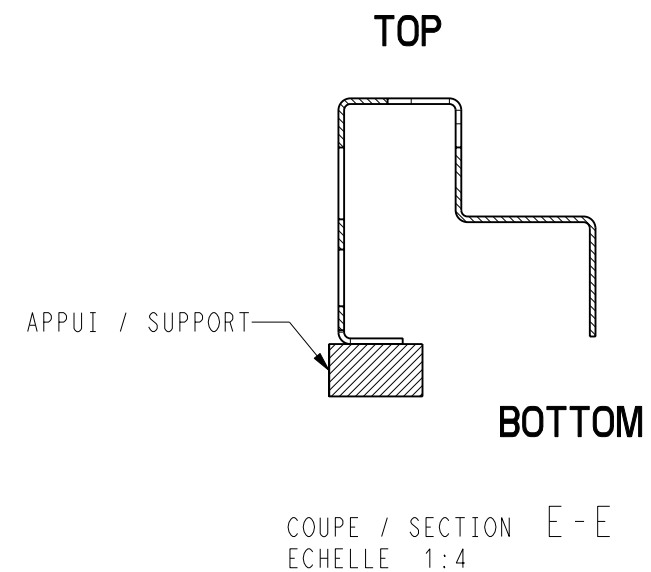
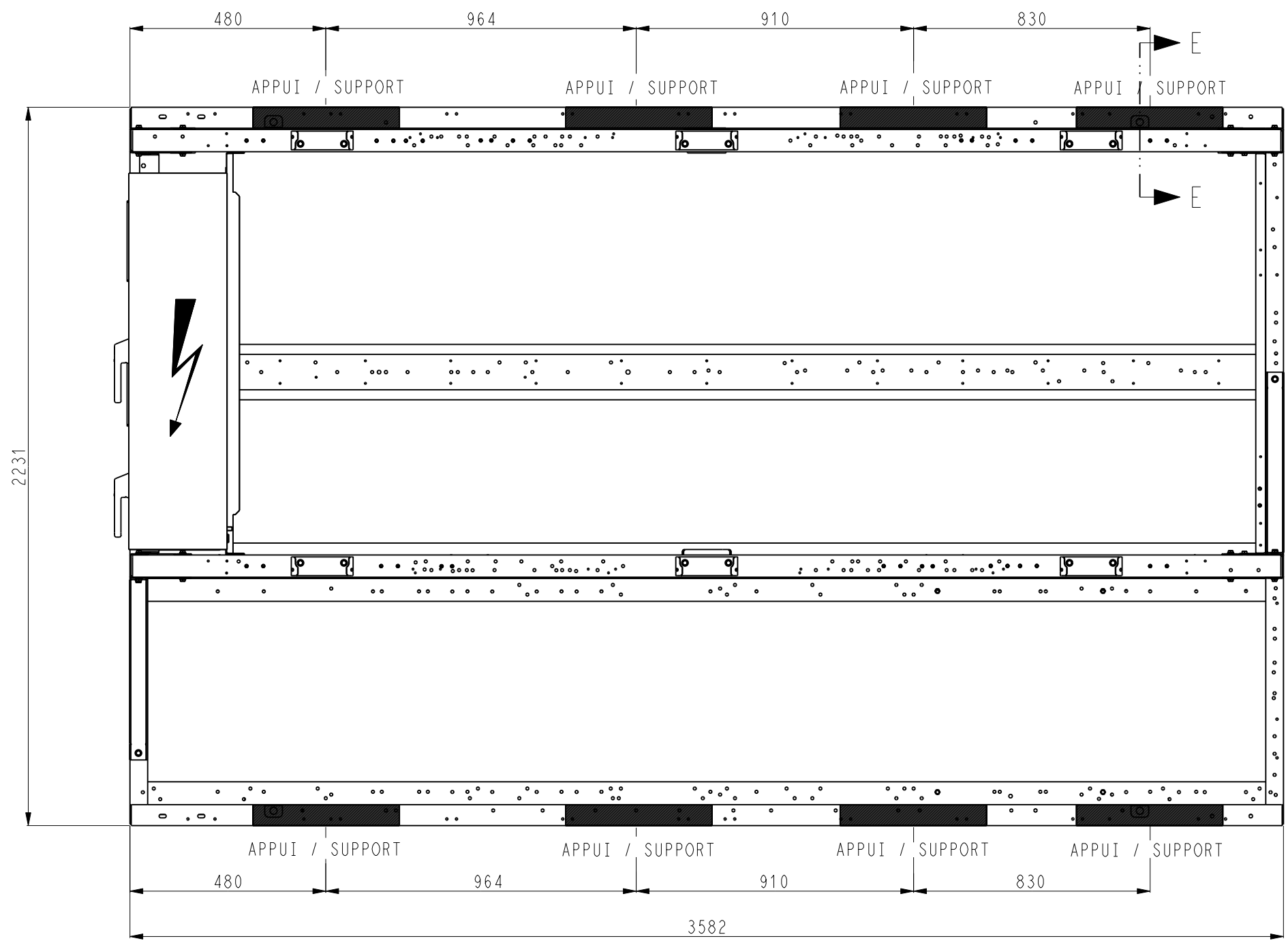

TOLERANCE	LX-UNIT		DATE	Feuille Sheet 3/12 Indice A
±10	*		03-May-18	

3V-OPT50+116x

OPTION PLOTS ANTIVIBRATILS
ANTI-VIBRATION MOUNTS OPTION

LX 0808 / 0908 / 1008

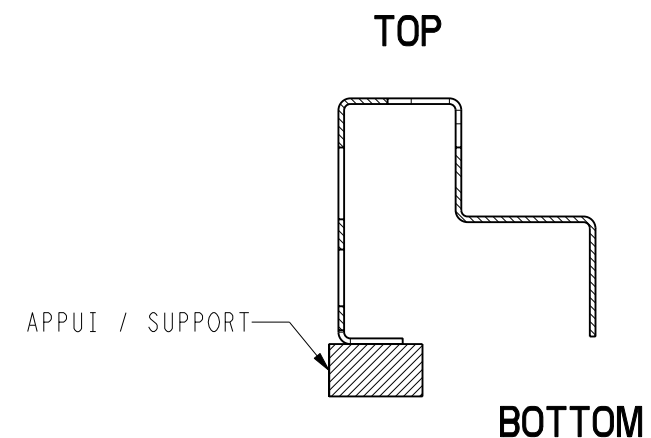
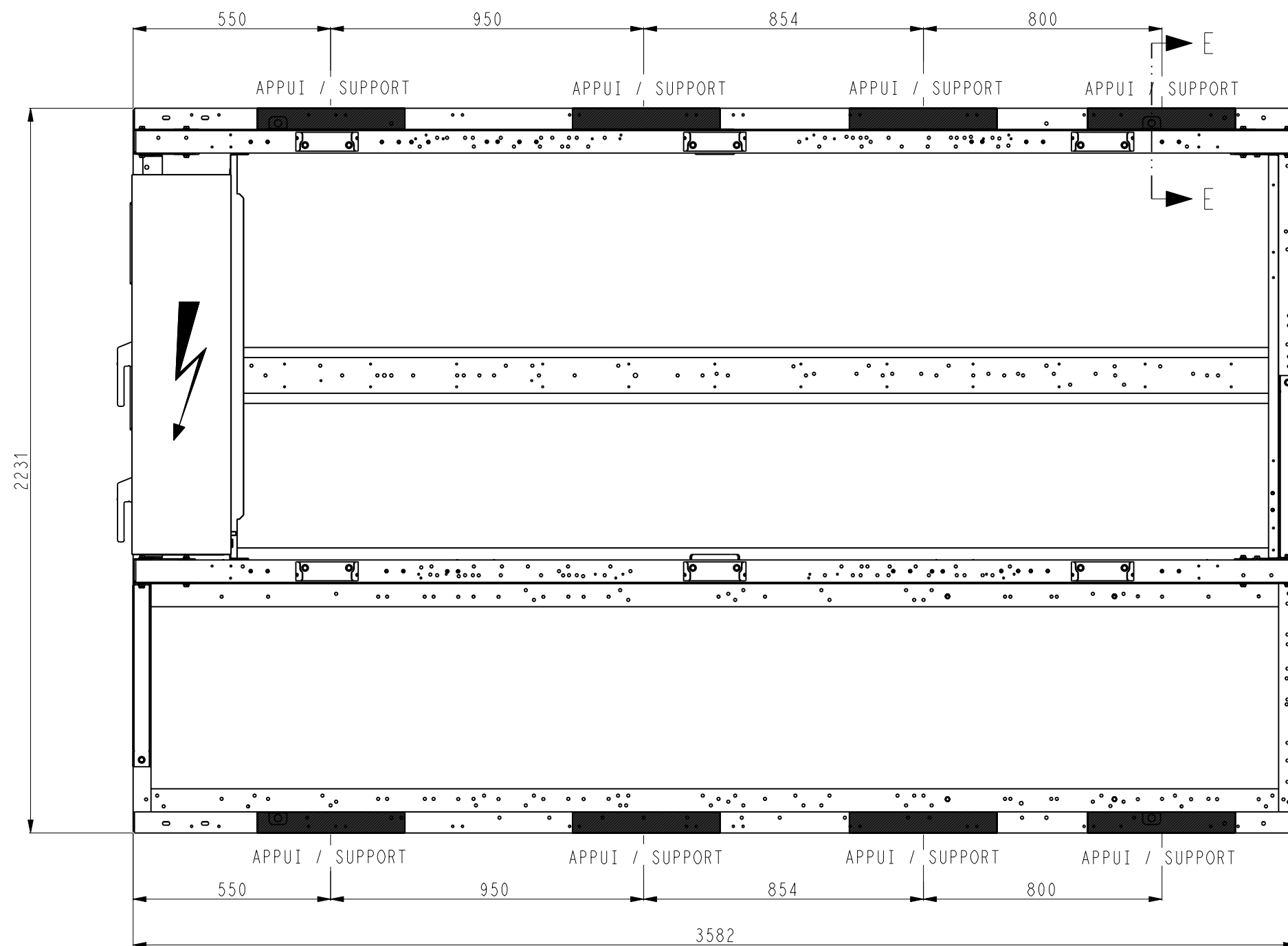

COUPE / SECTION E-E
ECHELLE 1:4

TOLERANCE	LX-UNIT		DATE	Feuille Sheet 4/12 Indice A
±10	*		03-May-18	
00DCG000330700				

4V-STD

OPTION PLOTS ANTIVIBRATILS
ANTI-VIBRATION MOUNTS OPTION

LX 1108 / 1358

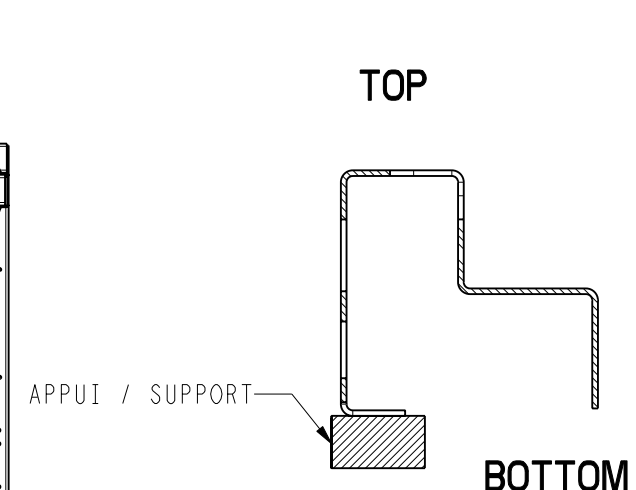
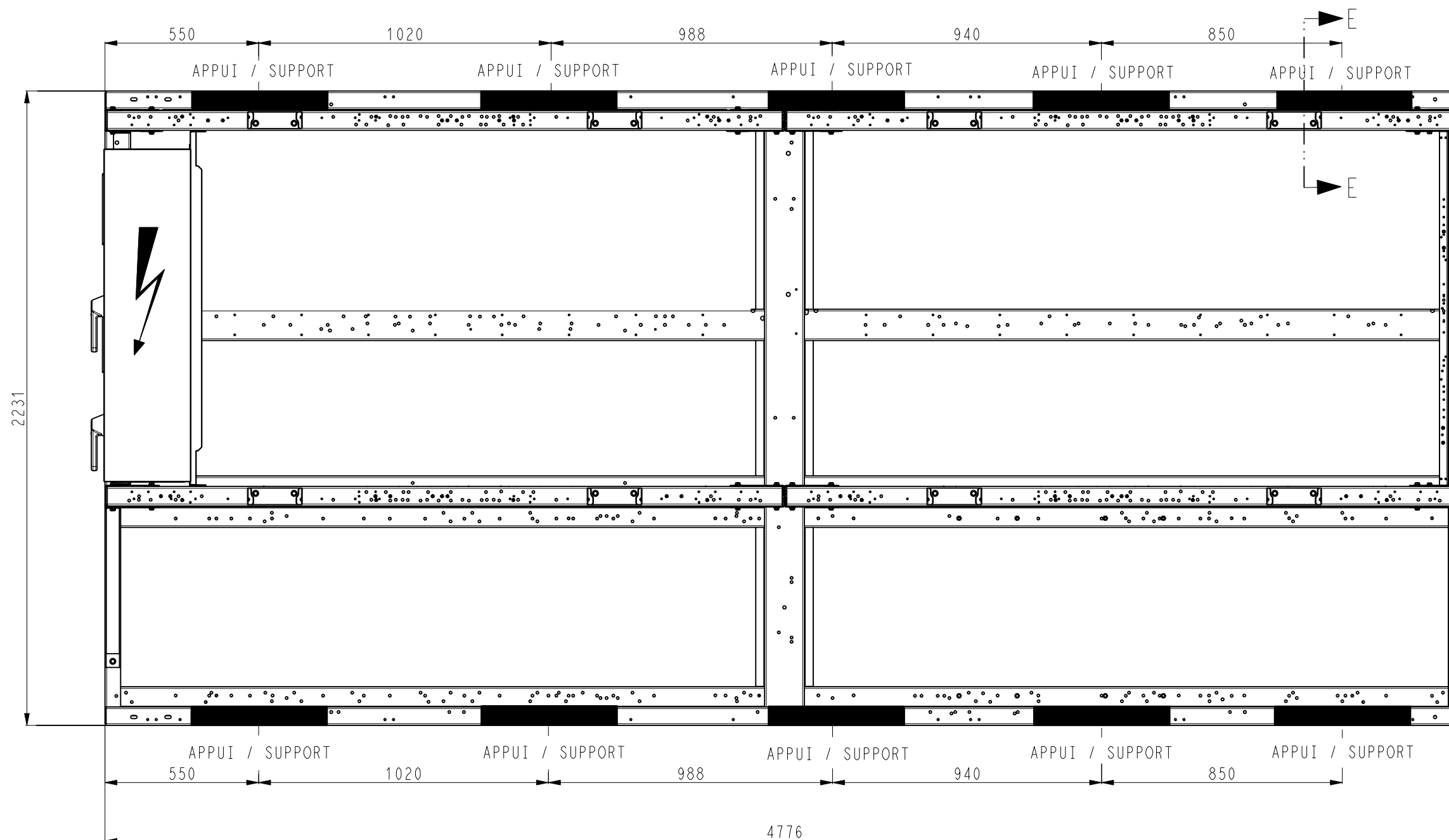

COUPE / SECTION E-E
ECHELLE 1:4

TOLERANCE	LX-UNIT		DATE	Feuille Sheet 5/12 Indice A
±10	*		03-May-18	
00DCG000330700				

4V-OPT50

OPTION PLOTS ANTIVIBRATILS
ANTI-VIBRATION MOUNTS OPTION

LX 1108 / 1358

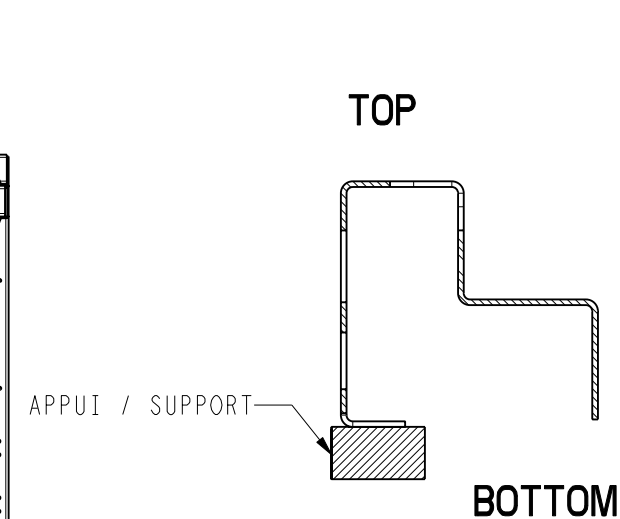
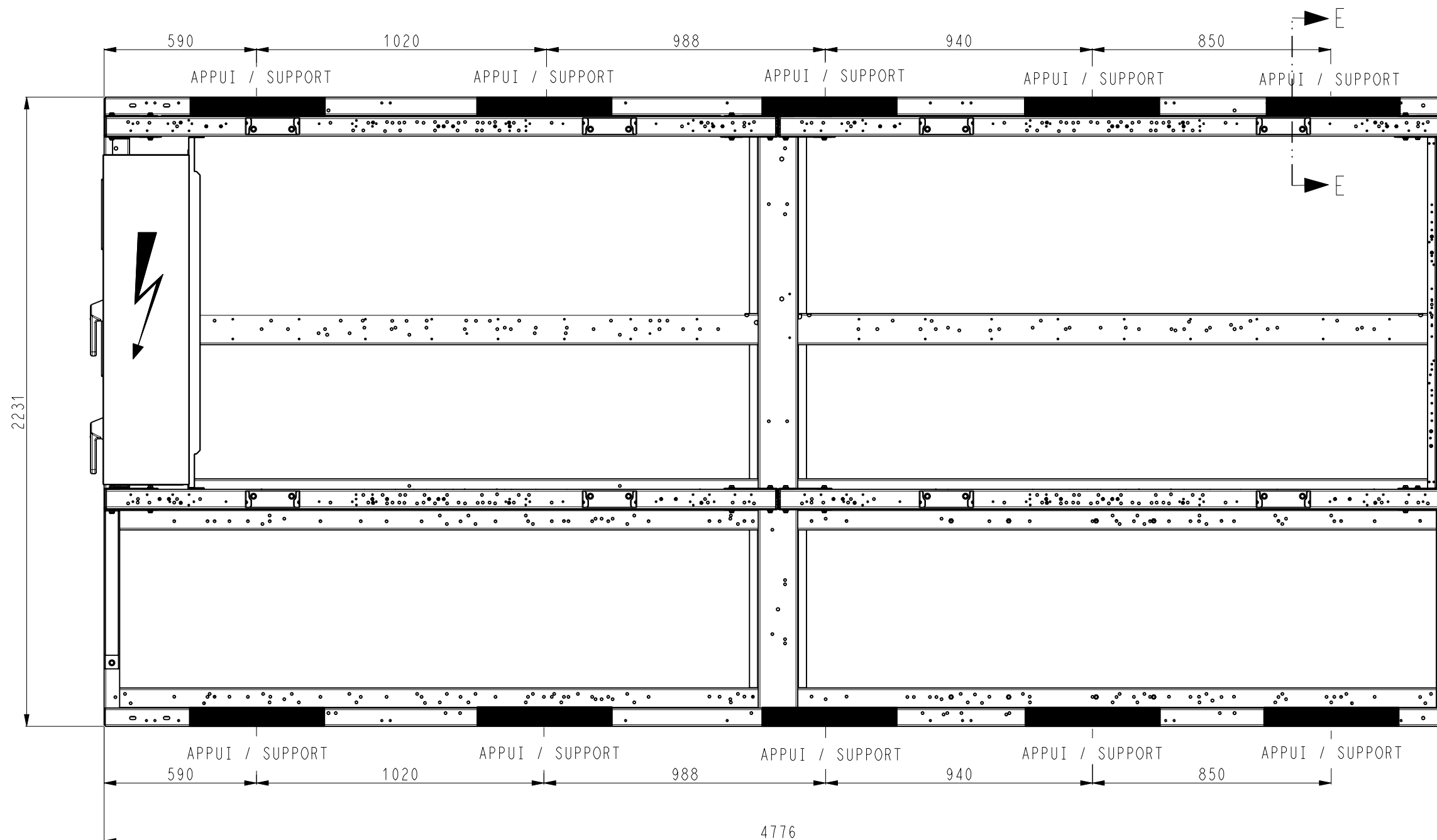

COUPE / SECTION E-E
ECHELLE 1:4

TOLERANCE	LX-UNIT		DATE	Feuille
±10	*		03-May-18	Sheet
		00DCG000330700		6/12
				Indice
				A

4V-OPT116x

OPTION PLOTS ANTIVIBRATILS
ANTI-VIBRATION MOUNTS OPTION

LX 1108 / 1358

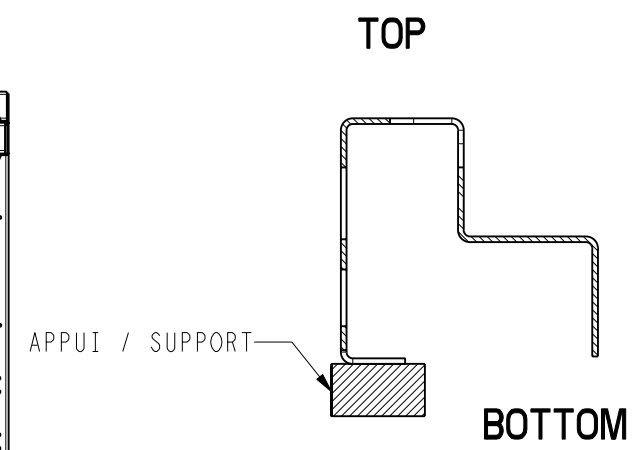
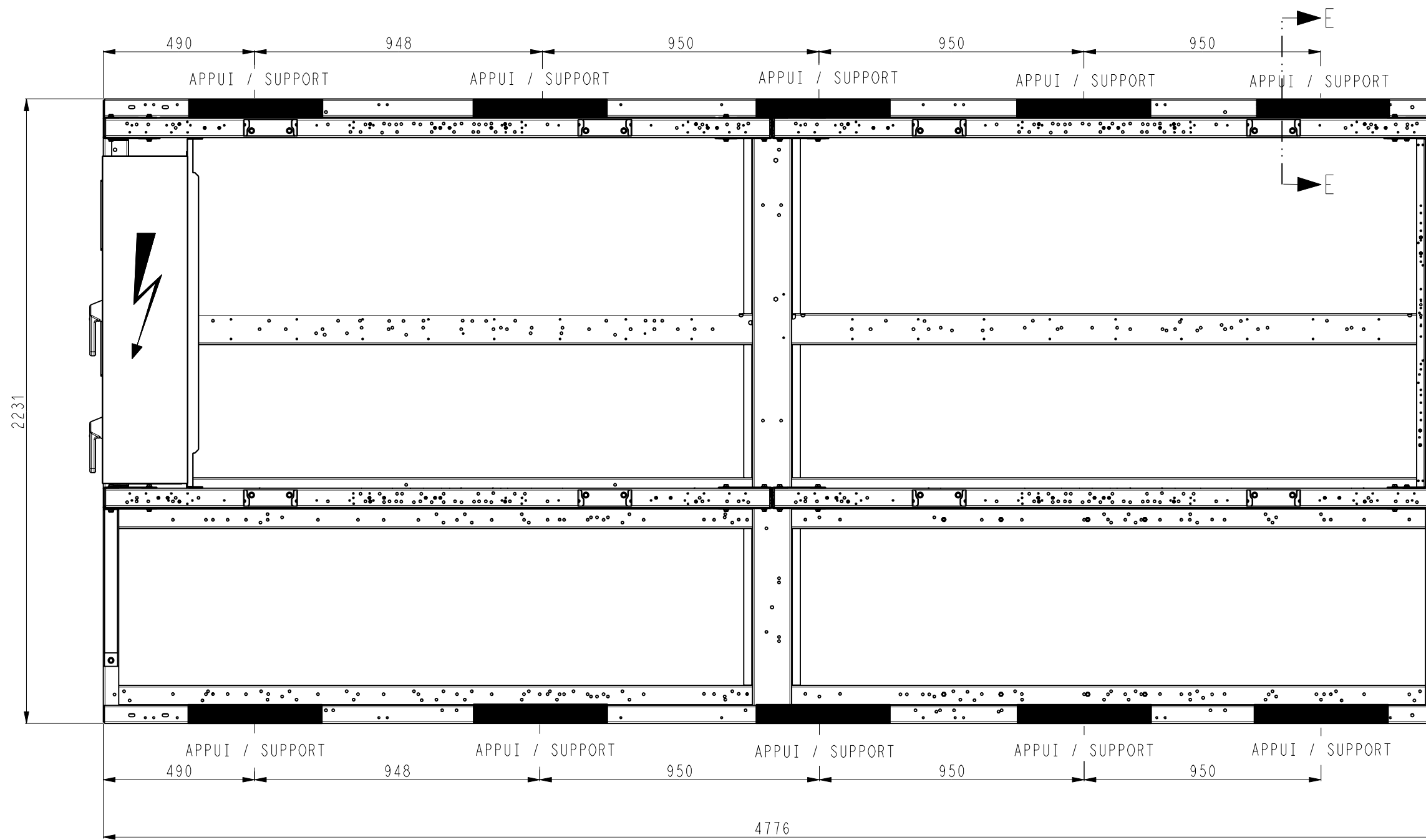

COUPE / SECTION E-E
ECHELLE 1:4

TOLERANCE	LX-UNIT		DATE	Feuille
±10	*		03-May-18	Sheet
00DCG000330700			Indice	A

4V-OPT50+116x

OPTION PLOTS ANTIVIBRATILS
ANTI-VIBRATION MOUNTS OPTION

LX 1108 / 1358

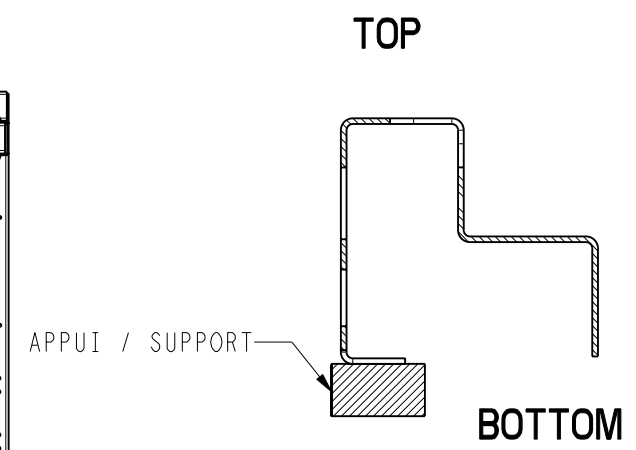
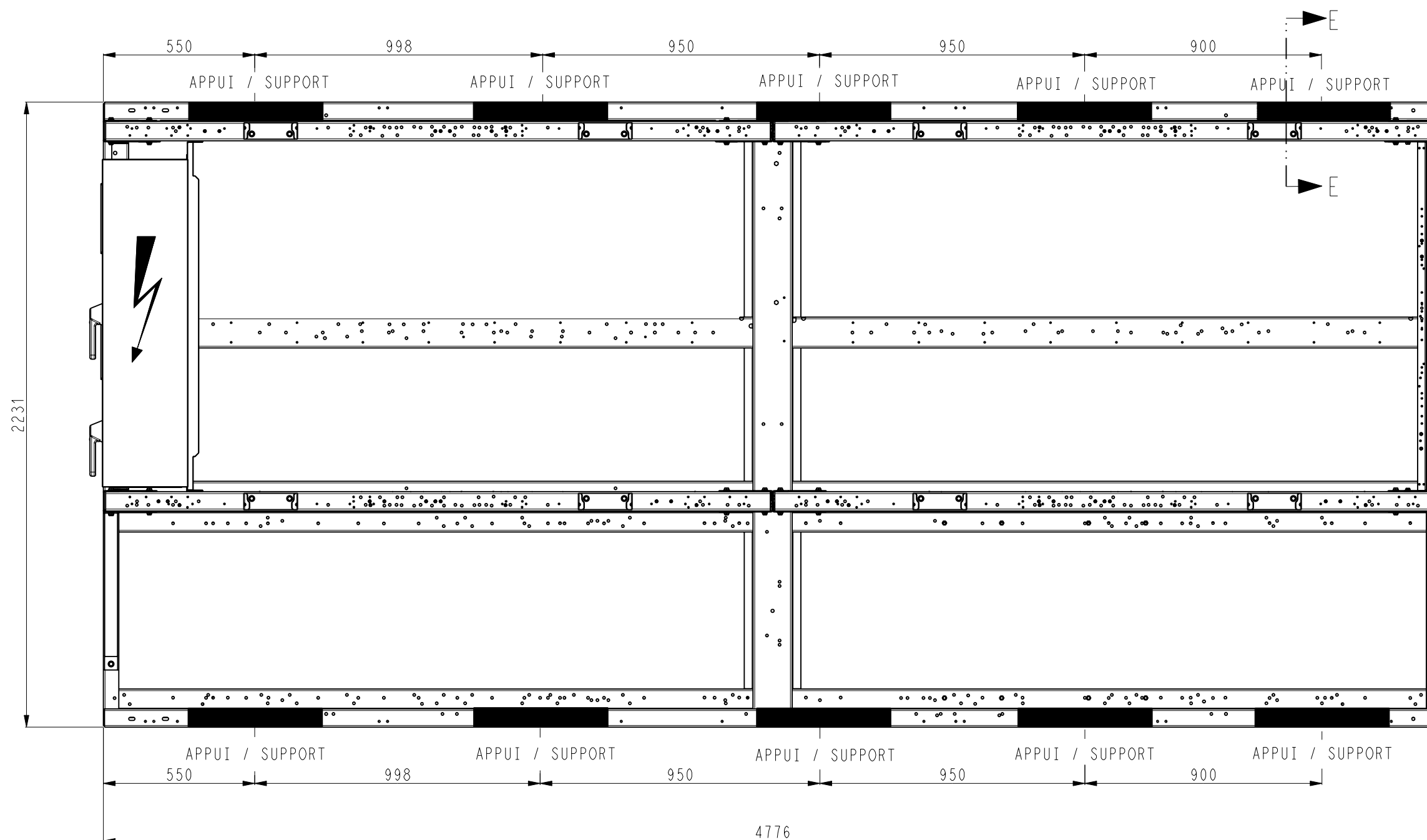

COUPE / SECTION E-E
ECHELLE 1:4

TOLERANCE	LX-UNIT		DATE	Feuille
±10	*		03-May-18	Sheet
		00DCG000330700		8/12
				Indice
				A

5V-STD

OPTION PLOTS ANTIVIBRATILS
ANTI-VIBRATION MOUNTS OPTION
LX 1528

TOP

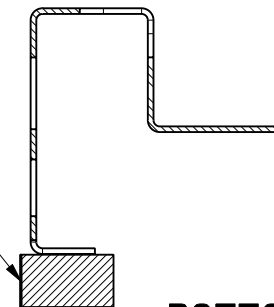

BOTTOM

COUPE / SECTION E-E
ECHELLE 1:4

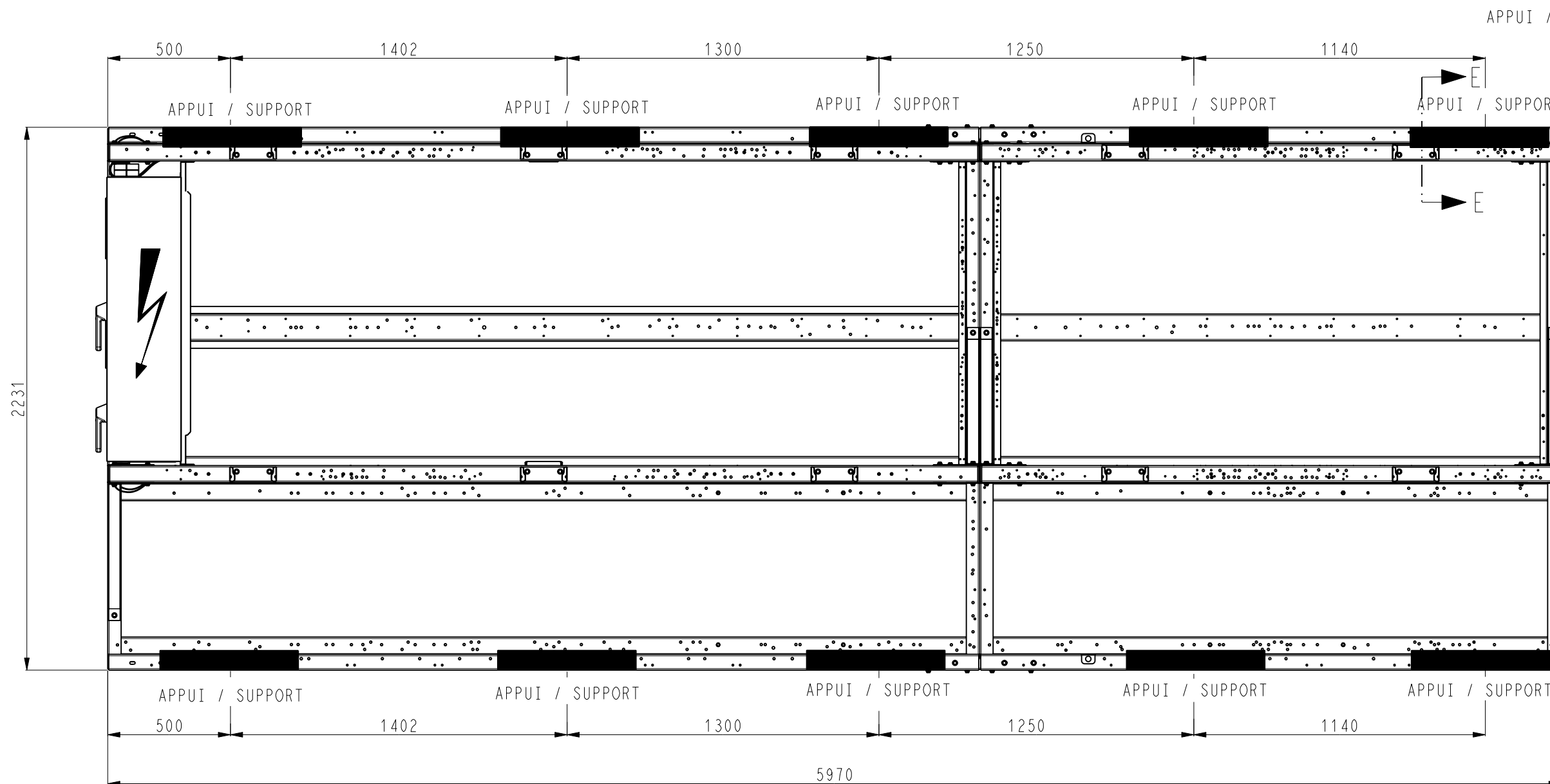

TOLERANCE	LX-UNIT		DATE	Feuille Sheet 9/12 Indice
±10	*		03-May-18	
		00DCG000330700	A	

5V-OPT50

OPTION PLOTS ANTIVIBRATILS
ANTI-VIBRATION MOUNTS OPTION
LX 1528

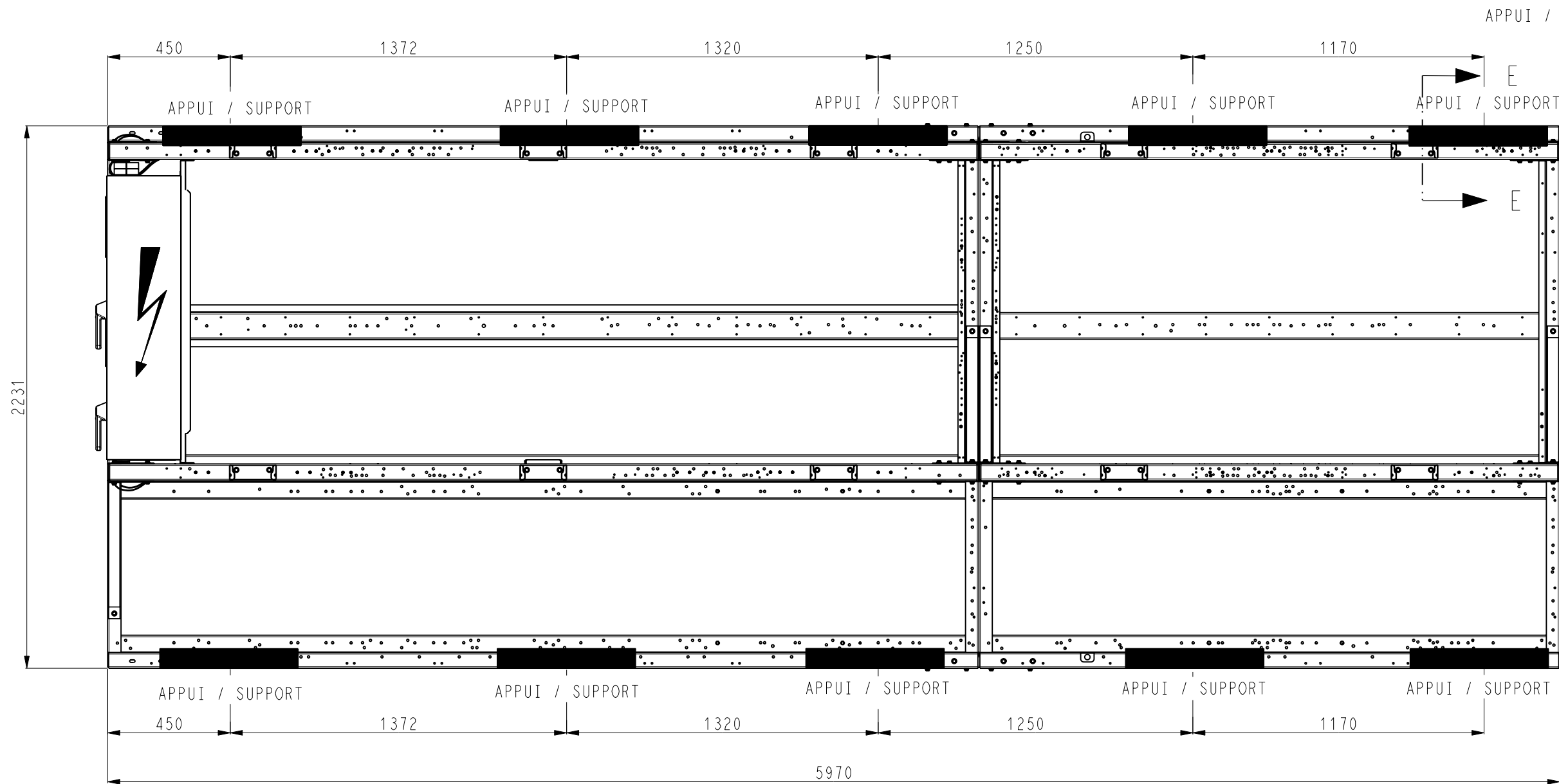
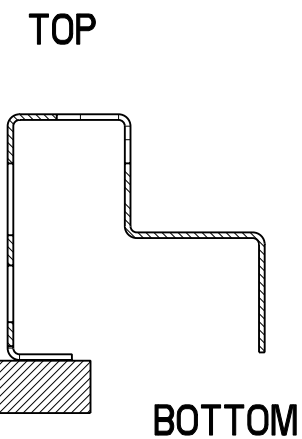

COUPE / SECTION E-E
ECHELLE 1:4

TOLERANCE	LX-UNIT		DATE	Feuille
±10	*		03-May-18	Sheet
00DCG000330700			Indice	A

5V-OPT116x

OPTION PLOTS ANTIVIBRATILS
ANTI-VIBRATION MOUNTS OPTION
LX 1528

TOP

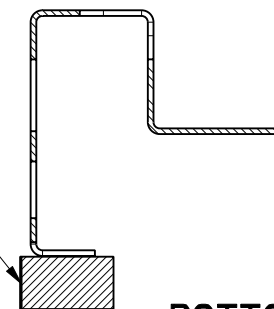

BOTTOM

COUPE / SECTION E-E
ECHELLE 1:4

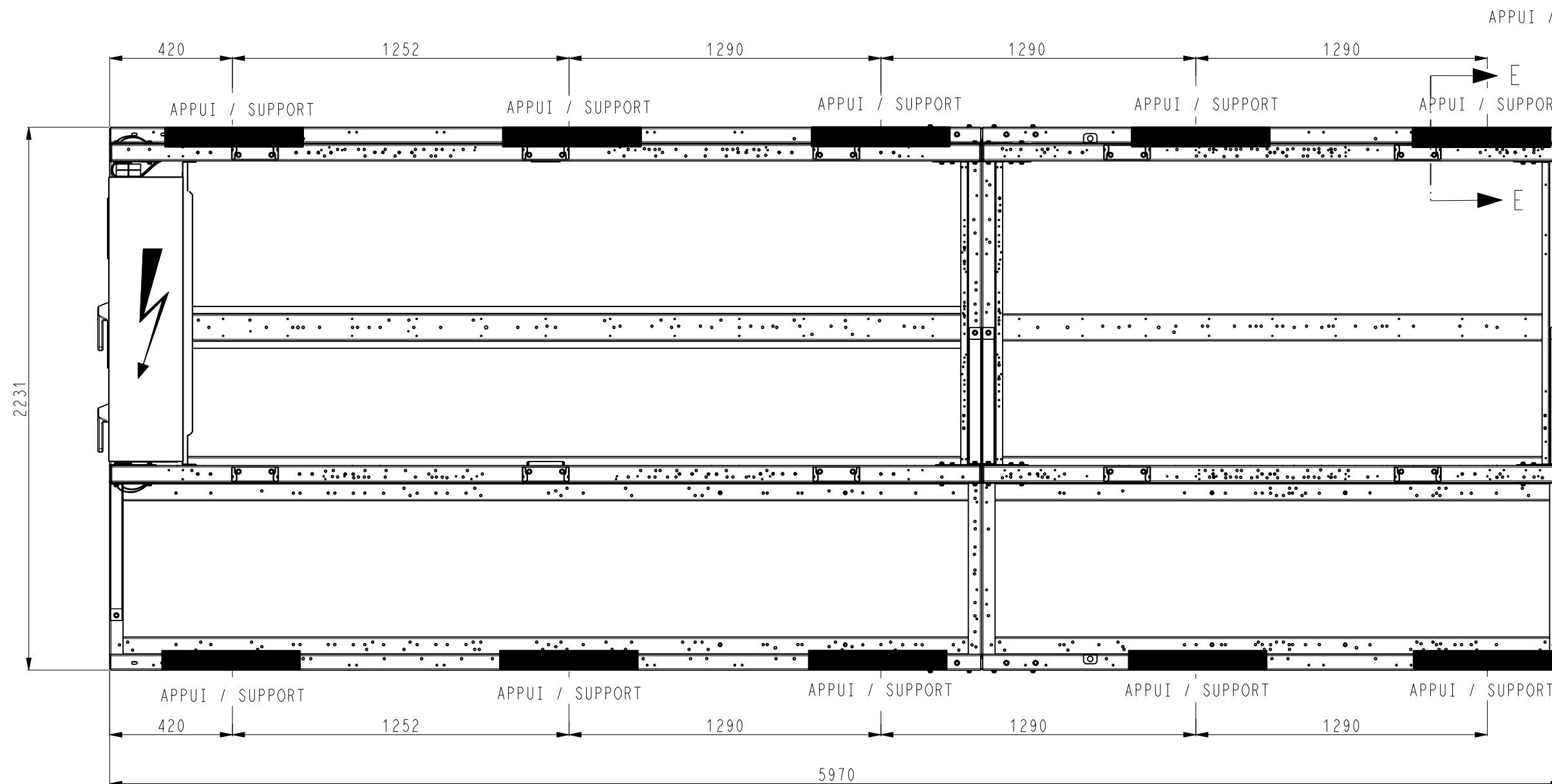

TOLERANCE	LX-UNIT		DATE	Feuille
±10	*		03-May-18	Sheet
00DCG000330700			Indice	A

5V-OPT50+116x

OPTION PLOTS ANTIVIBRATILS
ANTI-VIBRATION MOUNTS OPTION
LX 1528

TOP

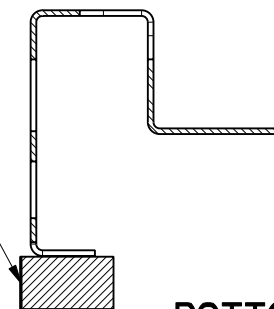

BOTTOM

COUPE / SECTION E-E
ECHELLE 1:4

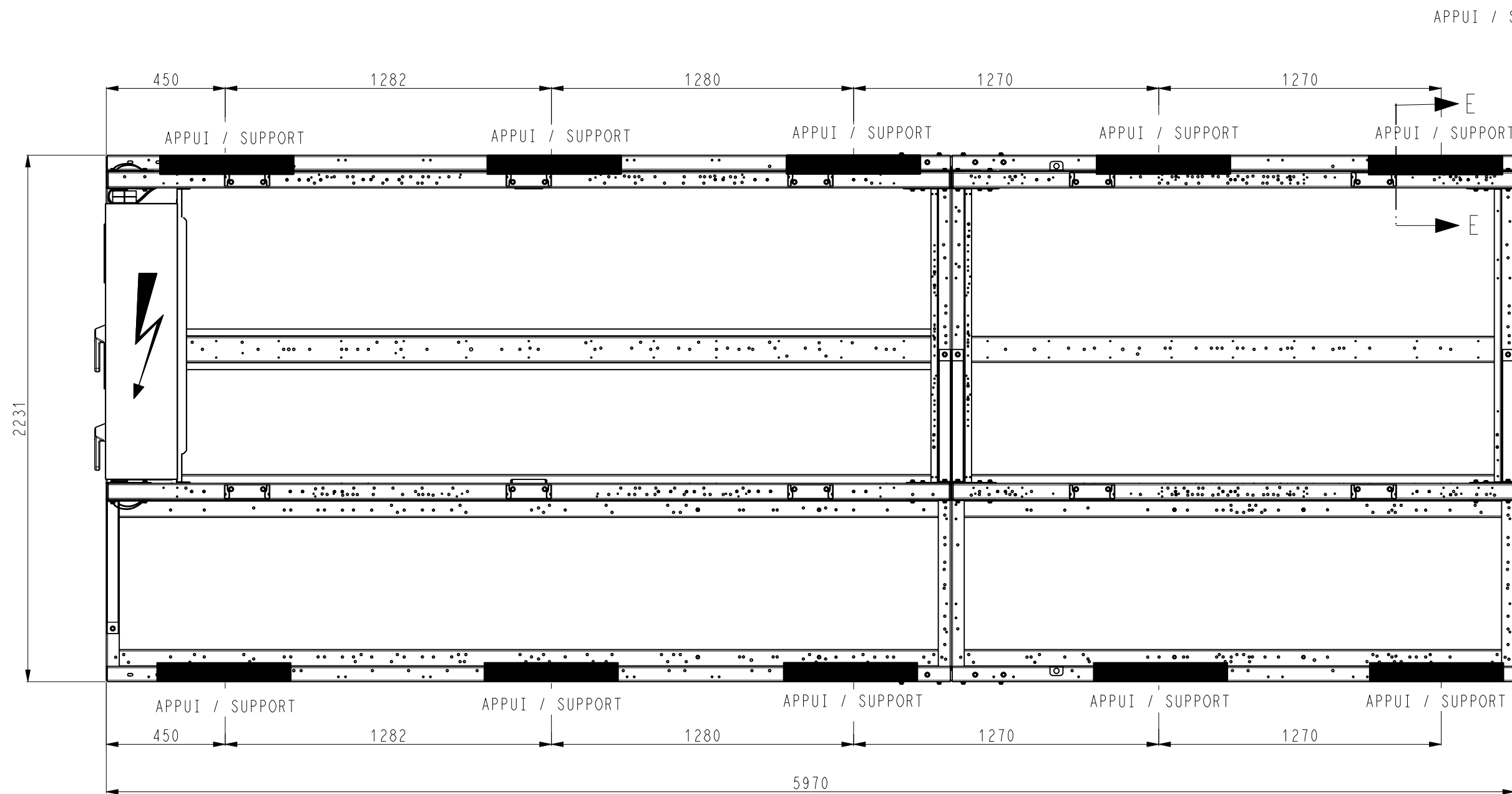

TOLERANCE	LX-UNIT		DATE	Feuille Sheet 12/12 Indice
±10	*		03-May-18	
		00DCG000330700		A