

10589

09 - 2024

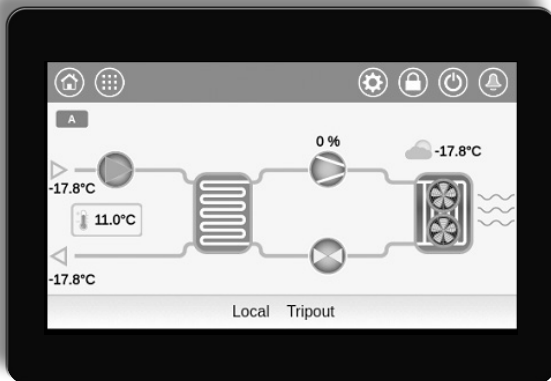
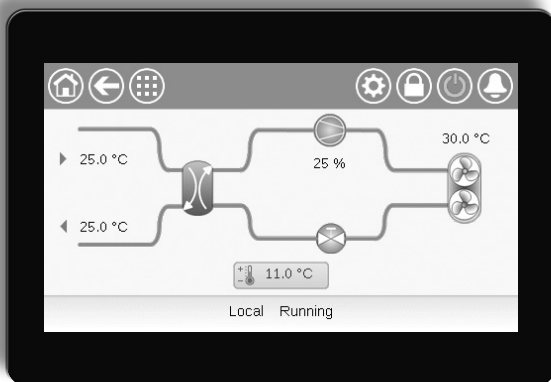

# AQUACIAT (I)LD (150R-600R) CONNECT TOUCH

Instruction manual



# CONTENTS

---

<b>1 - SAFETY CONSIDERATIONS</b> .....	<b>5</b>
1.1 - Safety guidelines.....	5
1.2 - Safety precautions.....	5
<b>2 - CONTROL OVERVIEW</b> .....	<b>6</b>
2.1 - Control system.....	6
2.2 - System functionalities.....	6
2.3 - Control panel.....	6
2.4 - Operating modes.....	6
2.5 - Features overview.....	6
<b>3 - HARDWARE</b> .....	<b>7</b>
3.1 - Control boards.....	7
3.2 - Power supply to boards.....	7
3.3 - Light emitting diodes on boards.....	7
3.4 - Electrical box.....	7
3.5 - Touch panel connections.....	8
3.6 - Pressure transducers.....	9
3.7 - Temperature sensors.....	9
3.8 - Actuators.....	9
3.9 - Terminal block connections.....	10
3.10 - RS485 wiring (best practice).....	11
<b>4 - USER INTERFACE: OVERVIEW</b> .....	<b>12</b>
4.1 - Touch screen display.....	12
4.2 - Connect Touch.....	12
4.3 - Information message box.....	12
4.4 - Connect Touch 2.0.....	12
4.5 - Screen calibration.....	13
4.6 - Warning messages.....	13
4.7 - Header buttons.....	14
4.8 - Other buttons.....	14
<b>5 - USER INTERFACE: MENU STRUCTURE</b> .....	<b>15</b>
5.1 - Main menu.....	15
5.2 - Configuration menu.....	24
5.3 - Schedule menu.....	28
5.4 - Holiday menu.....	28
5.5 - Network menu.....	29
5.6 - System menu.....	31
5.7 - Login menu.....	34
5.8 - Start / stop menu.....	35
5.9 - Alarms menu.....	36
<b>6 - CONTROL SYSTEM OPERATION</b> .....	<b>38</b>
6.1 - Unit start/stop control.....	38
6.2 - Smart Grid Ready (option 157D).....	38
6.3 - Heating/Cooling/Standby.....	39
6.4 - Heating/Cooling selection.....	39
6.5 - Pumps control.....	40
6.6 - Hydronic kit option.....	41
6.7 - Control point.....	41
6.8 - Capacity limitation.....	42
6.9 - Capacity control.....	42
6.10 - Night mode.....	43
6.11 - Coil pressure control.....	43
6.12 - Dry Cooler Free Cooling (DCFC).....	43
6.13 - Refrigerant leakage detection (option 159).....	43
6.14 - Refrigerant leakage detection (option 159C).....	43
6.15 - Desuperheater option.....	43
6.16 - Defrost control.....	44
6.17 - Master/slave assembly.....	44
6.18 - Brine options (option 5, option 6).....	44
6.19 - BACnet option (option 149).....	44
6.20 - Modbus (option 149B).....	44
6.21 - Heating optimized (option 119D).....	44
6.22 - Software Activation Key(s).....	44
6.23 - Schedule setting.....	45
6.24 - Holidays.....	46
6.25 - Trendings.....	46

# CONTENTS

---

<b>7 - WEB CONNECTION.....</b>	<b>47</b>
7.1 - Web interface .....	47
7.2 - Connect to the web interface.....	47
7.3 - Technical documentation.....	47
7.4 - Connect Touch 2.0 web interface.....	48
<b>8 - DIAGNOSTICS .....</b>	<b>49</b>
8.1 - Control diagnostics.....	49
8.2 - Displaying current alarms.....	49
8.3 - E-mail notifications .....	49
8.4 - Resetting alarms .....	49
8.5 - Alarm history.....	49
8.6 - Alarm description.....	50
<b>9 - MAINTENANCE.....</b>	<b>57</b>
<b>10 - APPENDIX 1: SMART GRID READY INSTALLATION INSTRUCTIONS.....</b>	<b>58</b>
10.1 - Introduction.....	58
10.2 - Configuration of Smart Grid Ready option .....	58
10.3 - Smart Grid Ready operating modes.....	60
10.4 - Wiring: Smart Grid connections.....	62

# PREFACE

---

The goal of this document is to give a broad overview of the main functions of the control system used to control AQUACIAT LD R32 air-cooled liquid chillers (150R-600R) and AQUACIAT ILD R32 heat pumps (150R-600R).

Instructions in this manual are given as a guide to good practice in the installation, start-up and operation of the control system. This document does not contain full service procedures for the correct operation of the equipment.

It is possible to monitor and manage the operation of the chiller/heat pump from either a local colour touch screen panel installed in the electrical cabinet of the machine or the web interface.

- Please note that the Connect Touch display panel has been superseded by the Connect Touch 2.0 touch screen.
- The layout and design of the web interface may differ based on the type of the touch screen installed on the machine.  
For units equipped with the legacy "Connect Touch" touch screen, the organisation of pages is the same both on the touch screen and the web interface.  
Connect Touch 2.0 touch screen comes with the new web user interface design which allows for easy navigation across different functionalities of the control system.
- This document applies to both versions of the touch screen. Please refer to the relevant section of this document.

The support of a qualified Manufacturer Service Engineer is strongly recommended to ensure optimal operation of the equipment as well as the optimization of all available functionalities.

**CAUTION: Heating option applies only to heat pumps.**

Note that this document may refer to optional components and certain functions, options or accessories may not be available for the specific unit. The cover images are solely for illustration and form no part of any offer for sale or any sale contract.

**IMPORTANT: All screenshots of the user interface provided in this manual include text in English. After changing the language of the system, all labels will be in the language selected by the user.**

**Please read all instructions prior to proceeding with any work. Pay attention to all safety warnings.**

The information provided herein is solely for the purpose of allowing customers to operate and service the equipment and it is not to be reproduced, modified or used for any other purpose without the prior consent of Manufacturer.

# ABBREVIATIONS

---

In this manual, the refrigeration circuits are called circuit A and circuit B. Compressors in circuit A are labelled A1, A2, A3, whereas compressors in circuit B are labelled B1, B2.

**The following abbreviations are used frequently:**

BMS	Building Management System
DCFC	Dry Cooler Free Cooling
DGT	Discharge Gas Temperature
DST	Daylight Saving Time
EHS	Electric Heater Stage
EVSP	External Variable Speed Pump
EXV	Electronic Expansion Valve
UI	User Interface
FC	Free Cooling
HSM	Hydronic System Manager
LED	Light Emitting Diode
LEN	Sensor Bus (internal communication bus linking the basic board to slave boards)
LFL	Lower Flammability Limit
OAT	Outdoor Air Temperature
SCT	Saturated Condensing Temperature
SST	Saturated Suction Temperature
VFD	Variable Frequency Drive

**Operating modes:**

Local-Off/LOFF	Operating type: Local Off
Local-On/L-C	Operating type: Local On mode
Local-Schedule/L-SC	Operating type: Local On following a time schedule
Master mode/Mast	Operating type: Master unit (master/slave assembly)
Network mode/Net	Operating type: Network
Remote mode/Rem	Operating type: Remote contacts

# 1 - SAFETY CONSIDERATIONS

---

## 1.1 - Safety guidelines

Installation, start-up and servicing of equipment can be hazardous if certain factors particular to the installation are not considered: operating pressures, electrical components, voltages, and the installation site (elevated plinths and built-up structures).

Only qualified installation engineers and fully trained technicians are authorised to install and start the equipment.

All instructions and recommendations provided in the service guide, installation and operation manuals, as well as on tags and labels fixed to the equipment, components and other accompanying parts supplied separately must be read, understood and followed.

Failure to comply with the instructions provided by the manufacturer may result in injury or product damage.

- **Apply all safety standards and practices.**
- **Wear safety glasses and gloves.**
- **Use the proper tools to move heavy objects.**
- **Move units carefully and set them down gently.**

**CAUTION: Only qualified service technicians should be allowed to install and service the equipment.**

## 1.2 - Safety precautions

Only personnel qualified in accordance with IEC (International Electrotechnical Commission) recommendations may be permitted access to electrical components.

It is particularly recommended that all sources of electricity to the unit should be shut off before any work is begun. Shut off the main power supply at the main circuit breaker or isolator.

**IMPORTANT: The equipment uses and emits electromagnetic signals. Tests have shown that the equipment conforms to all applicable codes with respect to electromagnetic compatibility.**

**RISK OF ELECTROCUTION! Even when the main circuit breaker or isolator is switched off, specific circuits may still be energised as they may be connected to a separate power source.**

**RISK OF BURNS! Electrical currents may cause components to get hot. Handle the power cable, electrical cables and conduits, terminal box covers and motor frames with great care.**

## 2 - CONTROL OVERVIEW

### 2.1 - Control system

AQUACIAT chillers and heat pumps are equipped with CONNECT TOUCH control that serves as the user interface and configuration tool for communicating devices. The advanced CONNECT TOUCH control comes with web connectivity.

AQUACIAT LD chillers and AQUACIAT ILD heat pumps are typically use fixed speed fans or variable speed fans as an option. Variable speed fans reduce the unit energy use during occupied and unoccupied periods, provide condensing or evaporating pressure control and smooth fan start.

For AQUACIAT LD chillers and AQUACIAT ILD heat pumps, the system may control fixed speed pumps or variable speed pumps with a hydronic module.

**IMPORTANT: This document may refer to optional components and certain functions, options or accessories may not be available for the specific unit.**

### 2.2 - System functionalities

The system controls the start-up of the compressors needed to maintain the desired heat exchanger entering and leaving water temperature. It constantly manages the operation of the fans in order to maintain the correct refrigerant pressure in each circuit and monitors safety devices that protect the unit against failure and guarantee its optimal functioning.

#### CONNECT TOUCH control system:

- Allows users to control the unit via the CONNECT TOUCH user interface
- Provides web connectivity technology
- Includes the trending functionality
- Supports Enhanced Control Management for multiple chillers/heat pumps configuration (BluEdge Digital, Cristo'Control2, Power'Control, Smart CIATControl)
- Provides direct BMS integration capabilities (Proprietary Protocol RS485, Modbus RTU or TCP option, LON option, BACnet IP option)

### 2.3 - Control panel

Navigation through the Connect Touch control is either using the touch screen interface or by connecting to the web interface.

The legacy Connect Touch display panel has been superseded by the Connect Touch 2.0 touch screen.

Connect Touch touch screen	Connect Touch 2.0 touch screen
a resistive LCD touch screen	a capacitive LCD screen
the same layout of menus on the touch screen and the web UI	new web user interface design (web UI design different from the touch screen display)
CEPL131228-01-R*	CEPL131256-01-R*

\* The CEPL number can be found on the sticker on the back of the touch screen.

### 2.4 - Operating modes

The control can operate in three independent modes:

- **Local mode:** The unit is controlled by commands from the user interface.
- **Remote mode:** The unit is controlled by dry contacts.
- **Network mode:** The unit is controlled by network commands (Proprietary Protocol, Modbus or BACnet). Data communication cable is used to connect the unit to the Proprietary Protocol communication bus.

When the control operates autonomously (Local or Remote), it retains all of its control capabilities but does not offer any of the features of the Network.

**CAUTION: Emergency stop! The Network emergency stop command stops the unit regardless of its active operating type.**

### 2.5 - Features overview

Feature	Chillers		Heat pumps	
	Standard	Option	Standard	Option
4.3" touch screen	✓		✓	
Web connectivity	✓		✓	
E-mail transmission	✓		✓	
Connected Services	✓		✓	
Language packs	✓		✓	
Language pack customization	✓		✓	
Metric / Imperial unit display	✓		✓	
History trends	✓		✓	
BMS connection	✓		✓	
Proprietary protocol	✓		✓	
BACnet IP communication		✓		✓
Modbus RTU / Modbus TCP communication		✓		✓
LonTalk		✓		✓
Scroll compressor technology	✓		✓	
Fixed speed fans	✓		✓	
Variable speed fans		✓		✓
High static fan		✓		✓
Water exchanger cooler/heater	✓		✓	
Air exchanger	✓		✓	
Water pumps control (fixed or variable speed)	✓		✓	
Fixed or variable speed pumps		✓		✓
Heating / Cooling control	✓		✓	
Boiler control				✓
Electric heating control				✓
Dry Cooler Free Cooling		✓		✓
Defrost mechanism			✓	
Free defrost mechanism			✓	
Brine fluid		✓		✓
Frost protection cooler/heater		✓		✓
Desuperheater		✓		✓
Service / User Quick Test	✓		✓	
Diagnostics	✓		✓	
Leakage detection (option 159C)		✓		✓
Heating optimized (option 119D)				✓
Smart Grid Ready*		✓		✓

\* The Smart Grid Ready label is valid only in the DACH region (Germany, Austria, Switzerland).

## 3 - HARDWARE

### 3.1 - Control boards

Each circuit is by default fitted with one SIOB/CIOB board used to manage all major inputs and outputs of the controller.

Largest sizes and options, such as Dry Cooler Free Cooling, require the installation of an additional AUX1 board. Units with fixed speed fans are fitted with AUX1 board.

All I/O boards communicate via an internal LEN bus.

### 3.2 - Power supply to boards

All boards are supplied from a common 24 VAC supply referred to earth.

**CAUTION: Maintain correct polarity when connecting the power supply to the boards, otherwise the boards may be damaged.**

In the event of a power supply interrupt, the unit restarts automatically without the need for an external command. However, any faults active when the supply is interrupted are saved and may in certain cases prevent a given circuit or the unit from restarting.

### 3.3 - Light emitting diodes on boards

All boards continuously check and indicate the proper operation of their electronic circuits. A light emitting diode (LED) lights on each board when it is operating properly.

- The red LED flashing for a two-second period indicates correct operation. A different rate indicates a board or a software failure.
- The green LED flashes continuously on all boards to show that the board is communicating correctly over its internal bus (LEN bus). If the green LED is not flashing, this indicates a LEN bus wiring problem or a configuration issue.

### 3.4 - Electrical box

The electrical box includes all boards controlling the unit and the user interface.

The main board continuously monitors the information received from various pressure and temperature probes and accordingly starts the program that controls the unit.

The unit is equipped with the CONNECT TOUCH user interface. The number of boards available in the electrical box depends on the number of selected options.

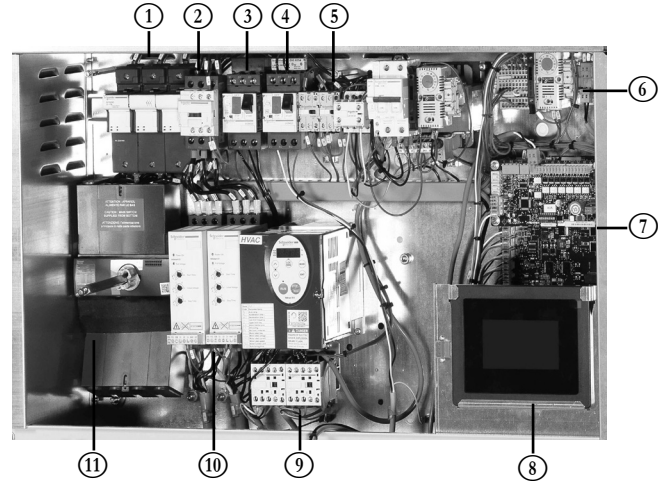

#### Legend:

1. Fuse holder compressor
2. Compressor contactor
3. Disconnect switch pump
4. Disconnect switch fan
5. Heaters relay
6. Control circuit
7. SIOB/CIOB board + AUX1 board
8. CONNECT TOUCH display
9. Pump drive + pump contactors
10. Compressor soft starters
11. Main breaker

### 3 - HARDWARE

#### 3.5 - Touch panel connections

Connections are located on the bottom of the controller.

- The control offers RS485 communication protocols such as LEN, Proprietary Protocol, Modbus.
- One Ethernet port allows for IP communication (Web server, BACnet, Modbus, etc.) for BMS (Building Management System) connection.

The position of connectors varies depending on the model of the touch screen. For example, J8 and J10 connectors are placed in the opposite order (left/right position).

##### 3.5.1 - Connections of Connect Touch display

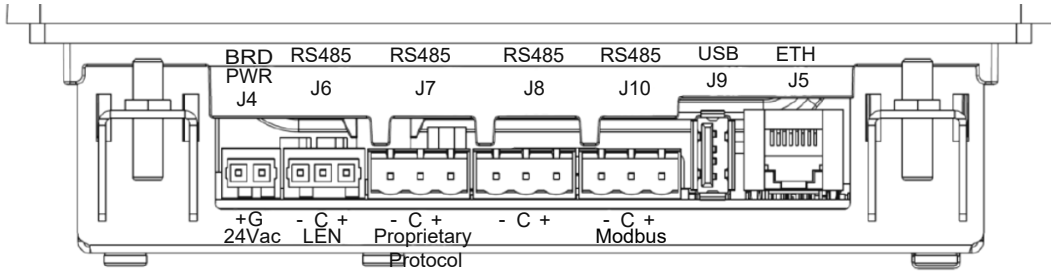

##### 3.5.2 - Connections of Connect Touch 2.0 display

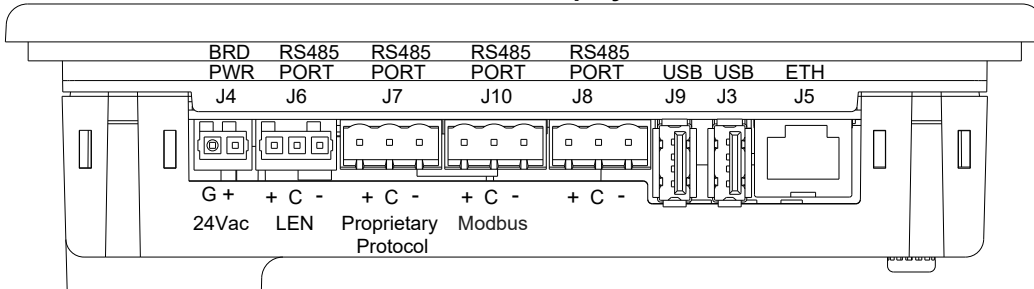



## 3 - HARDWARE

### 3.6 - Pressure transducers

Three types of transducers (high pressure, low pressure, water pressure) are used to measure various pressures in each circuit. These transducers deliver 0 to 5 VDC. They are connected to the SIOB/CIOB board.

- **Discharge pressure transducers (high pressure type)**  
These transducers measure the discharge pressure in each circuit. They are used to control condensing pressure or high pressure load shedding. Discharge pressure sensors are mounted on the discharge line piping of each circuit.
- **Suction pressure transducers (low pressure type)**  
These transducers measure the suction pressure in each circuit. They are used to control EXV, evaporating pressure (in heating mode) and monitor suction pressure safeties related to the compressor operating envelope. Suction pressure sensors are located on the common suction piping of each circuit.
- **Pump inlet/outlet water pressure transducers (water pressure type, hydronic kit option)**  
These transducers measure the hydronic kit pump water inlet/outlet water pressure and monitor the water flow. Pump inlet/outlet water pressure sensors are mounted on the optional hydronic kit.
- **Leakage detection sensor(s) (optional)**  
One or two sensors will detect refrigerant leakage.

### 3.7 - Temperature sensors

Temperature sensors constantly measure the temperature of various components of the unit, ensuring the correct operation of the system.

- **Water heat exchanger entering and leaving water temperature sensors**  
The water heat exchanger entering and leaving water temperature sensors are used for capacity control and safety purposes.
- **Outdoor air temperature sensor**  
This sensor measuring the outdoor air temperature is used for start-up, setpoint temperature reset and frost control.
- **Suction gas temperature sensors**  
These sensors measure the suction gas temperature. They are used for the EXV control. Suction gas temperature sensors are located at the suction side of each circuit.
- **Coil balance temperature sensors (heat pumps)**  
On each circuit, this sensor is used to measure the Coil Temperature.
- **Discharge gas temperature sensors**  
On each circuit, this sensor is used to measure the Discharge Gas Temperature in order to maintain it below 150°C (302°F).
- **Defrost temperature sensors (heat pumps)**  
These sensors are used to determine the end of the defrost cycle for a given circuit.
- **Master/slave water sensor (optional)**  
This sensor measures the common water temperature in the master/slave system capacity control. It is installed only in the case of master/slave units.
- **Water tank temperature sensor**  
This sensor is used to measure the Water Tank Temperature.
- **Water loop temperature sensor**  
This sensor is used to measure the Water loop Temperature.

### 3.8 - Actuators

- **Electronic expansion valve**  
The electronic expansion valve (EXV) is used to adjust the refrigerant flow to changes in the operating conditions of the machine. The high degree of accuracy with which the piston is positioned provides precise control of the refrigerant flow and suction superheat.
- **Water flow switch**  
For units without internal pumps, the water flow switch configuration allows for the automatic control of the minimum water flow setpoint of the water flow switch. The configuration depends on the unit size and is made automatically at the start-up. If the flow switch fails, the alarm condition shuts off the unit.
- **Water heat exchanger pumps (optional)**  
The controller can regulate one or two fixed speed or variable speed water heat exchanger pumps and takes care of the automatic changeover between these pumps (see also section 6.5).
- **Variable speed fan (EC Motor)**  
Two outputs shall be used to control 0-10V Variable Speed Fan (two or one per circuit).
- **Three-way valve (DCFC option)**  
The control actuates the 3-way valve to ensure constant leaving water temperature.
- **Four-way valve (Heat Pump)**  
The control actuates the 4-way valve to manage cooling, heating and defrost.

### 3 - HARDWARE

#### 3.9 - Terminal block connections

Connections available at the user terminal block may vary depending on the selected options. The following table summarizes the connections at the user terminal block.

**IMPORTANT: Some contacts can be accessed only when the unit operates in Remote mode.**

Terminal block connections				
Description	Board	Input/Output	Connector	Remarks
On/Off switch	SIOB/CIOB, circuit A	DI-01	J1	Used for the unit on/off control (Remote mode)
Second setpoint switch	SIOB/CIOB, circuit A	DI-02	J1	Used to switch between setpoints
Demand limit switch 1 Demand limit switch 2	SIOB/CIOB, circuit A	DI-03 DI-04	J1	Used to control demand limit. See section 3.9.3
Flow switch Interlock	SIOB/CIOB, circuit A	DI-05	J34	Used for the flow switch safety loops
Heat/Cool select	SIOB/CIOB, circuit A	DI-06	J3	Used to switch between cooling and heating when the unit is in Remote mode (Heat pumps only)
High pressure switch	SIOB/CIOB, circuit A	DI-09	J4	Used to control high pressure
Setpoint reset signal	SIOB/CIOB, circuit A	AI-10	J9	Allows the user to reset the currently selected setpoint
Alarm relay	SIOB/CIOB, circuit A	DO-05	J23	Indicates alarms
Running relay	SIOB/CIOB, circuit A	DO-06	J22	Used to signal a running status (at least one compressor started)
External variable speed pump	SIOB/CIOB, circuit A	A0-01	J10	The control can regulate the water flow via the external variable speed pump (0-10 V)
<b>Optional</b>				
Desuperheater switch	SIOB/CIOB, circuit A	DI-07	J3	Used to extract the high pressure, high temperature heat from the refrigerant to "desuperheat" it to a lower pressure refrigerant
Electrical Heat Stage 1 Electrical Heat Stage 2 Electrical Heat Stage 3	SIOB/CIOB, circuit A	DO-03 DO-04 DO-05	J6 J6 J23	Used to control electrical heat stage
Boiler or Electrical Heat Stage 4	SIOB/CIOB, circuit A	DO-06	J22	Used to control boiler or electrical heat stage

#### 3.9.1 - Volt-free contact (on/off and cooling/heating)

On/off contacts and cooling/heating contacts are as follows:

Contact	Off	Cooling	Heating	Auto
On/Off contact	open	closed	closed	open
Cooling/heating contact	open	open	closed	closed

**Off:** Unit is stopped

**Cooling:** Unit is allowed to start in Cooling

**Heating:** Unit is allowed to start in Heating (heat pump)

**Auto:** Unit can run in Cooling or Heating in accordance with the changeover values. If the automatic changeover is enabled (Heat/Cool Select, GENUNIT - General Parameters), the operating mode is selected based on OAT.

#### 3.9.2 - Volt-free setpoint selection contact

This dry contact input is used to switch between setpoints. It is active only when the control is in Remote mode.

Contact	Cooling		Heating	
	Stp 1	Stp 2	Stp 1	Stp 2
Setpoint selection contact	open	closed	open	closed

#### 3.9.3 - Volt-free demand limit selection contact

Up to two dry contacts can be used to limit unit capacity.

Capacity limitation with two contacts is as follows:

Contact	100%	Limit 1	Limit 2	Limit 3
Demand limit 1 contact	open	closed	closed	open
Demand limit 2 contact	open	open	closed	closed

### 3 - HARDWARE

#### 3.10 - RS485 wiring (best practice)

For RS485 ports, one of the following cables can be used:

- For Proprietary Protocol or Modbus communication which is over 300 m or in a noisy environment with Variable Frequency Drive (VFD), a cable with two twisted pairs is recommended. For example, Belden 3106A or Alpha Wire 6454.
- For applications where the length of the cable is up to 300 m and there is no Variable Frequency Drive (VFD), it is possible to use cost-effective cable solutions, for example, Belden 8772.

Note that "+" and "-" are communication signals and they are from the same twisted pair.

The signal ground could be a single wire or a twisted pair and it should be connected to the "C" pin of J10 (Modbus RTU) or J7 (Proprietary Protocol). This wire is required so that all nodes on the bus share a common ground reference connection.

If a shield is used, then the shield cable should be properly terminated and connected as short as possible at **ONLY ONE END** to the chassis ground (4.3-inch controllers).

##### 3.10.1 - RS485 wiring: 4.3-inch controller

The following diagrams illustrate possible RS485 wiring schemes for 4.3-inch controllers.

The first wiring scheme is the best option (RECOMMENDED), but the second or the third wiring can also be used.

#### 3.10.2 - RS485: Daisy chain configuration

The following illustration shows proper 3-wire termination with a shield in a daisy chain configuration.

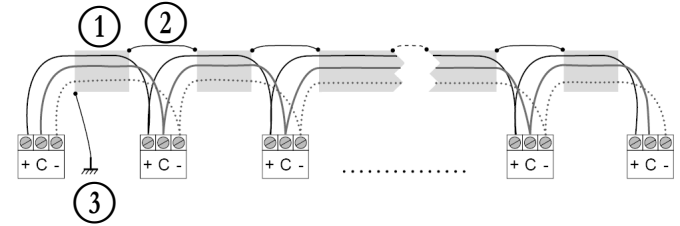

- Legend**
- ① Shield
  - ② Keep shield continued
  - ③ Connect shield to earth ground only at one point

**End of Line Resistor:** Termination is only needed when running at bus at very high speed over long distances.

The speed of the bus and the cable distance determines whether termination is needed. It is meant to balance the bus to minimize the ringing that may be caused by fast signals and the inductance of the cabling.

At 9600 baud, termination will have little or no effect on the bus.

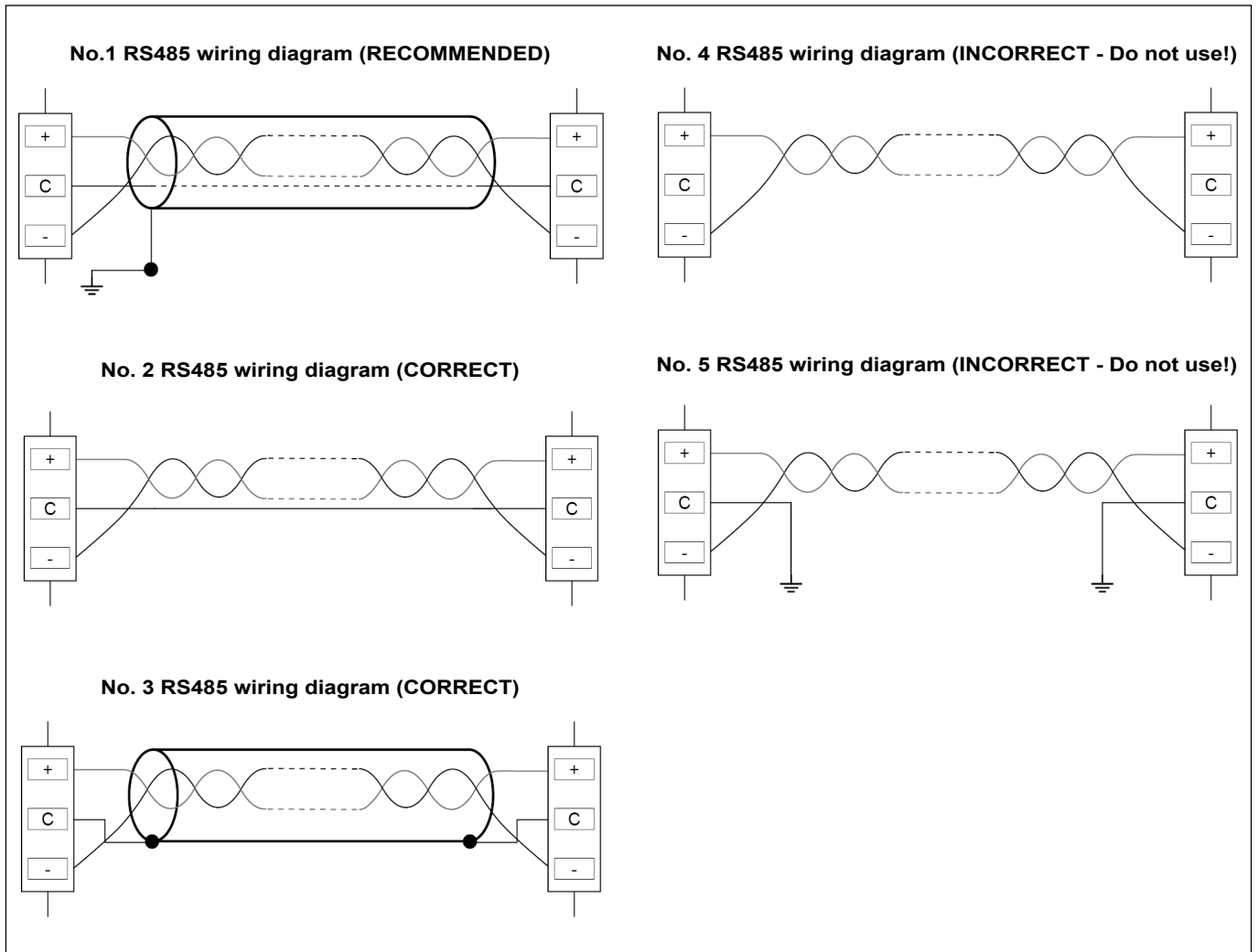

## 4 - USER INTERFACE: OVERVIEW

### 4.1 - Touch screen display

CONNECT TOUCH is a 4.3 in. colour touch screen with quick display of alarms, current unit operating status, etc. It allows for web connectivity and custom language support (control parameters displayed in the language selected by the user).

If the touch screen is not used for a while, the screen will go black. The control system is always active and the operating mode remains unchanged. Press anywhere on the screen and the Home screen will be displayed.

**The Connect Touch display panel has been superseded by the Connect Touch 2.0 touch screen.** The look of the display may slightly differ depending on the version of the touch screen that has been installed on the machine. For units with the Connect Touch 2.0 touch screen, please refer to section 4.4.

### 4.2 - Connect Touch

It is recommended to use a stylus for the navigation via the touch screen.

#### Home screen (synoptic view)

The home screen is the starting point of the controller. It is also the first screen shown after starting the user interface.

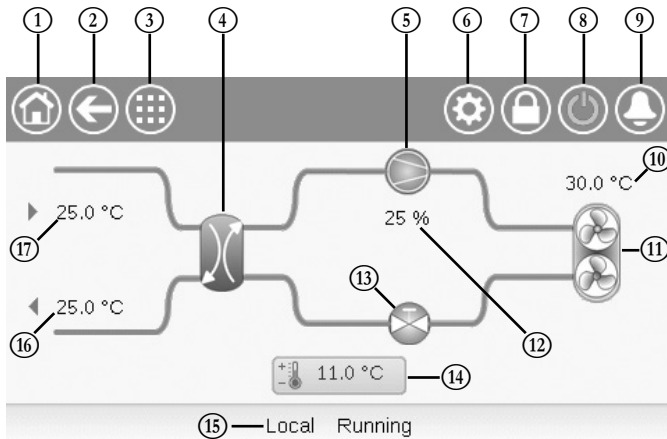

- |   |                                    |
|---|------------------------------------|
| ① Home button                               | ⑩ OAT (Outdoor Air Temperature)    |
| ② Back button                               | ⑪ Condenser fans                   |
| ③ Main menu button                          | ⑫ Unit capacity                    |
| ④ Heat exchanger                            | ⑬ EXV (Electronic Expansion Valve) |
| ⑤ Compressor                                | ⑭ Setpoint                         |
| ⑥ System menu                               | ⑮ Unit status                      |
| ⑦ Login button (restricted access to menus) | ⑯ LWT (Leaving Water Temperature)  |
| ⑧ Start/Stop button                         | ⑰ EWT (Entering Water Temperature) |
| ⑨ Alarm button                              |                                    |

### 4.3 - Information message box

The information displayed in the status bar at the bottom of the screen includes relevant messages related to actions taken by the user.

MESSAGE	STATUS
SUCCESS	Displayed when the requested action is executed.
INTERNAL COMMUNICATION FAILURE!	Displayed when the main application is not running.
HIGH FORCE IN EFFECT!	Displayed when the controller rejects the "Force" command (applicable only to status menus).
ACCESS DENIED!	Displayed when trying to perform actions not allowed at current access level.

### 4.4 - Connect Touch 2.0

Connect Touch 2.0 touch screen comes with a refreshed home screen design. You can control the touch screen with a bare finger or a suitable pen (a capacitive stylus pen). Pointed or cutting tools should not be used (e.g. screwdrivers).

#### Home screen

The home screen is the first screen displayed on the touch screen panel. This screen allows you to monitor basic information about the operation of the chiller and its working conditions.

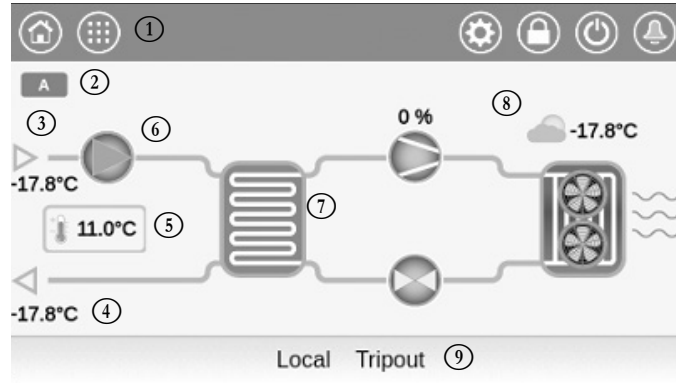

#### Legend:

- |                              |                           |
|------------------------------|---------------------------|
| ① Header buttons             | ⑥ Water pump              |
| ② Circuit icon               | ⑦ Refrigeration cycle     |
| ③ Entering Water Temperature | ⑧ Outdoor Air Temperature |
| ④ Leaving Water Temperature  | ⑨ Message box             |
| ⑤ Setpoint                   |                           |

#### ■ Circuit

For single-circuit chillers, there is only one circuit icon displayed (A for circuit A).

For dual-circuit chillers, two circuit icons will be displayed (A for circuit A, B for circuit B).

- Grey circuit icon = circuit is stopped
- Green circuit icon = circuit is running

#### ■ Evaporator Entering Water Temperature (EWT)

This is the temperature of the water returned from the building ("return water temperature").



#### ■ Evaporator Leaving Water Temperature (LWT)

This is the temperature of the chilled water produced by the chiller and supplied to the building ("supply water temperature").

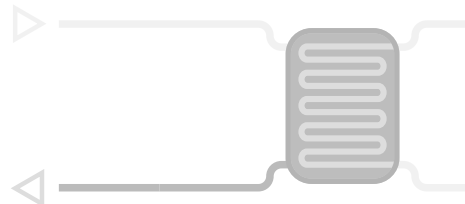

## 4 - USER INTERFACE: OVERVIEW

### ■ Setpoint

Setpoint is used to define the desired supply water temperature (Evaporator LWT).



Logged-in users are allowed to access chiller setpoint settings directly from the home screen: Tap  6.7C to open the setpoint configuration menu.

### ■ Water pump

A single-speed or variable-speed pump is used to circulate the working fluid through the equipment.

- Green pump icon = pump is running
- Grey pump icon = pump is stopped



Logged-in users can access pump parameters directly from the home screen: Tap  to open the pump menu.

### ■ Refrigeration cycle (Cooling mode)

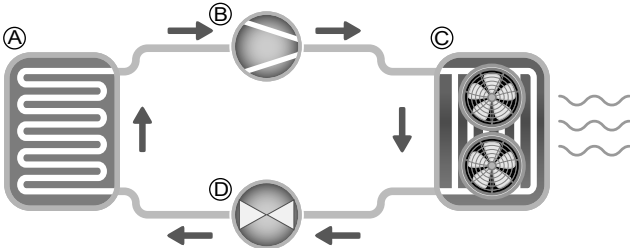

#### A) Evaporator

- Evaporator absorbs heat from the fluid (pure water or brine), it does the opposite of the condenser which is rejecting the heat out of the unit. Evaporator converts liquid refrigerant into vapours.

#### B) Compressor / circuit capacity

- This value shows current unit capacity.
- The compressor is used to squeeze the compressor refrigerant gas and turn it into high pressure gas.

#### C) Condenser

- Condenser is a heat exchanger used to reject the heat by cooling down the high pressure gases and taking advantage to condense the vapours into a liquid.

The number of fans given in the picture may be different from the actual number of fans installed on the unit.

#### D) Electronic Expansion Valve (EXV)

- EXV is used to control the flow of refrigerant into the evaporator.
- Valve position is given in %, where 0% means closed position and 100% means open position.

### ■ Outdoor Air Temperature

 OAT sensor reading. The outdoor air temperature sensor used to measure and monitor the temperature helps to optimize the cooling process whenever possible.

### 4.5 - Screen calibration

This setting applies only to the legacy Connect Touch display. The purpose of screen calibration is to make sure that the software acts correctly upon pressing icons on the user interface.

#### To calibrate the screen:

1. Press and hold anywhere on the screen.
2. The calibration process will start.
3. Please follow instructions displayed on the screen: *"Touch the target in (...) screen corner"*

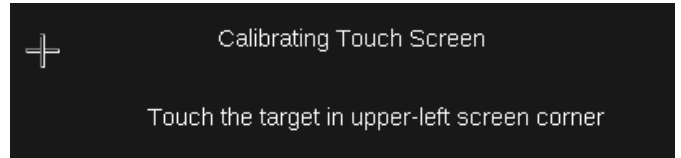

### 4.6 - Warning messages

Warning messages are used to inform the user that a problem occurred and the requested action cannot be completed successfully.

#### Login failure

If the wrong password is provided, the following warning message will be displayed:

*"The password entered does not match any stored passwords"*

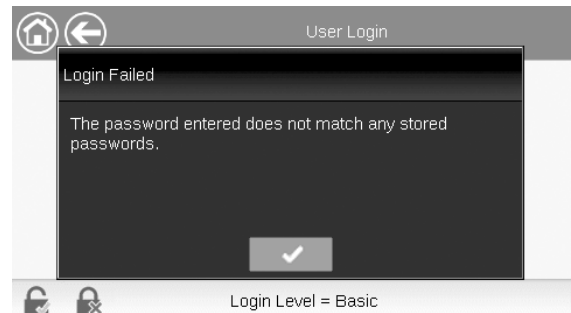

- Press **OK** and type the correct password (see section 5.7).

#### Saving modifications

In case a parameter has been changed, but not saved with the **Save** button, the following warning message will be displayed:



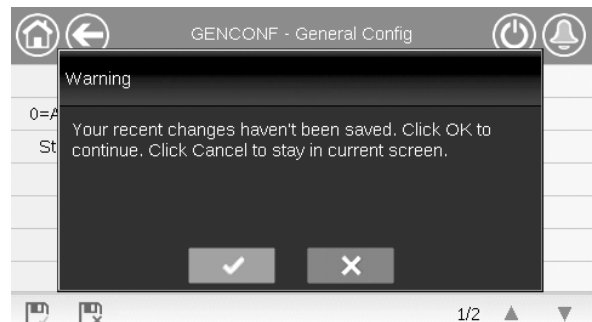











*"Your recent changes haven't been saved (...)"*



















- Press **OK** to continue without saving the modification.
- Press **Cancel** to come back to the current screen and then save the modification with the **Save** button.

# 4 - USER INTERFACE: OVERVIEW

## 4.7 - Header buttons

Button	Description
	<b>Home screen:</b> Press the button to go to the Home screen.
	<b>Previous screen:</b> Press the button to go back to the previous screen.
	<b>Main menu:</b> Press the button to go to the Main menu.
	<b>System menu:</b> Press the button to go to the System menu.
	<b>Login menu:</b> Used to log in to the controller in order to access higher configuration level.
	User is not logged in.
	User access level.
	<b>Unit Start/Stop:</b> Used to control the unit control mode.
	Unit is stopped.
	Unit is running.
	<b>Alarm menu:</b> Press the button to go to the Alarms menu.
	No alarm active on the unit
	<b>Blinking icon:</b> Partial alarm (one circuit affected by the existing alarm) or Alert (no action taken on the unit)
	<b>Steady icon:</b> Alarm(s) active on the unit

## 4.8 - Other buttons

Button	Description
	<b>Log in button:</b> Press the button to log in at specific access level.
	<b>Log off button:</b> Press the button to log off.
	<b>Save button:</b> Press the button to save the modification.
	<b>Cancel button:</b> Press the button to cancel the modification.
	<b>Force button:</b> Press the button to force the parameter.
	<b>Remove Force button:</b> Press the button to remove the forced parameter.
	<b>Up button:</b> Press the button to scroll up.
	<b>Down button:</b> Press the button to scroll down.
<b>On Connect Touch 2.0 touch screen:</b> Swipe up from the bottom of the screen or swipe down from the top of the screen to display and reach other items. Note: You can swipe up or down only in the menu view (the top bar and the bottom bar will not respond to swipe gestures).	
	<b>Confirm button:</b> Press the button to confirm the modification.
	<b>Cancel button:</b> Press the button to cancel the modification.
	<b>Trending button:</b> Press the button to display trends.
	<b>Zoom in button:</b> Press the button to magnify the current view.
	<b>Zoom out button:</b> Press the button to expand the current view.
	<b>Left button:</b> Press the button to go to the left.
	<b>Rewind button:</b> Press the button to go to the left faster than normal.
	<b>Right button:</b> Press the button to go to the right.
	<b>Fast-forward button:</b> Press the button to go the right faster than normal.

# 5 - USER INTERFACE: MENU STRUCTURE

## 5.1 - Main menu

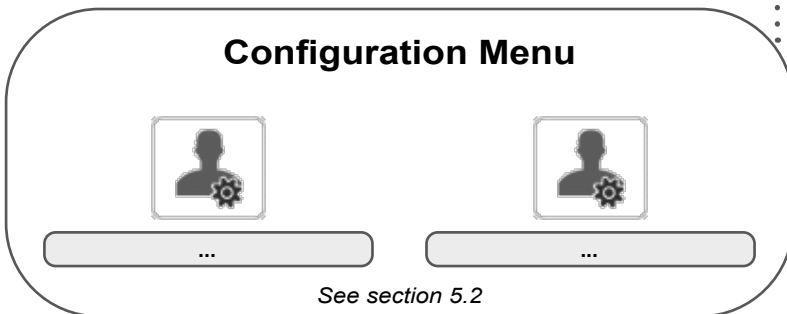
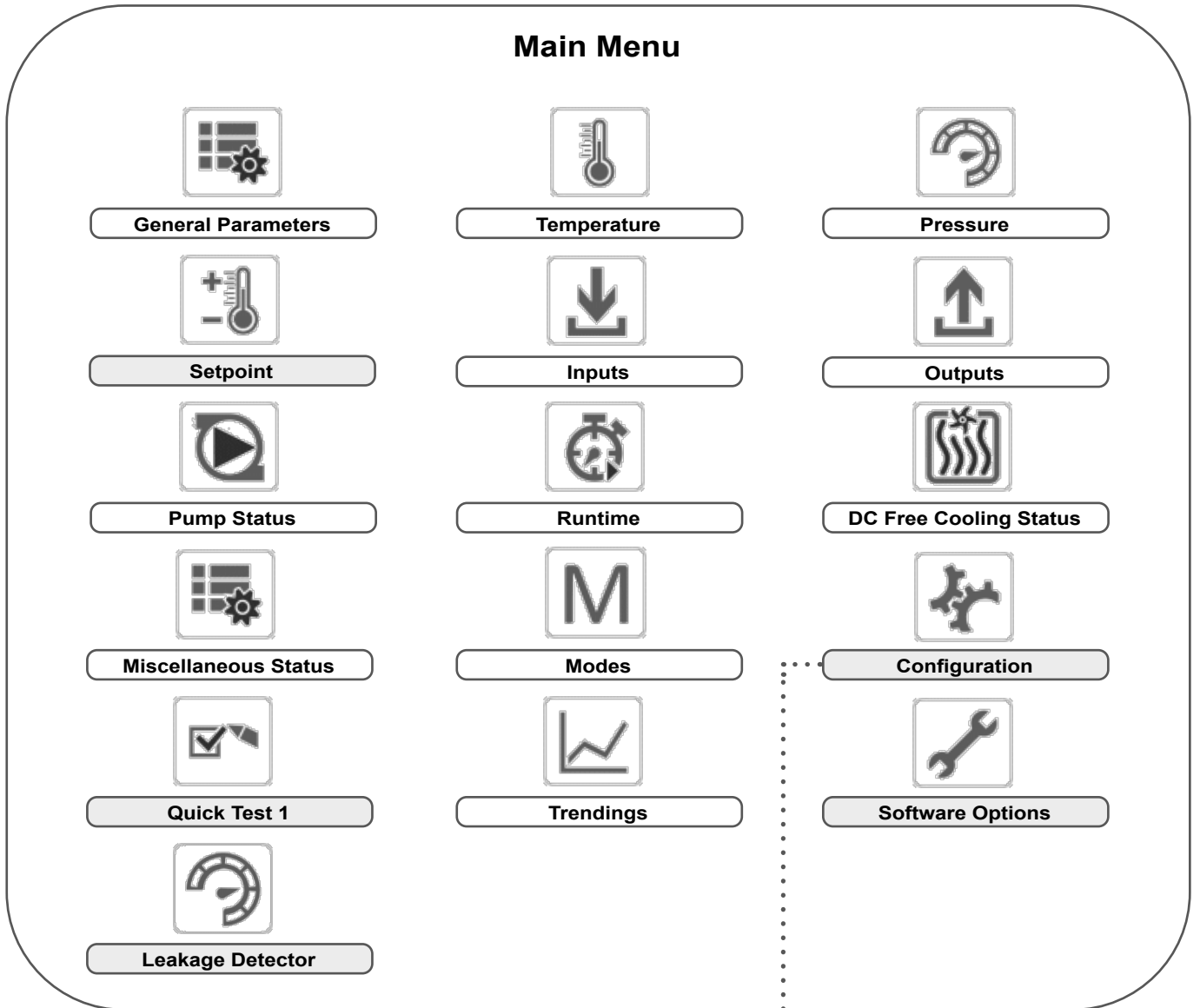

Legend:

- Basic access (no password)
- User password required

## 5 - USER INTERFACE: MENU STRUCTURE

The Main menu provides access to the main control parameters, including general parameters, inputs and outputs status, etc.

**NOTE: The Trendings menu is displayed in form of a graph. For more information about Trendings, see section 6.25.**

- To access the menu, press the **Main menu** button located in the upper-left part of the Home screen.
- Specific unit parameters can be accessed by pressing the icon corresponding to the desired category.

**CAUTION: Since specific units may not include additional features, some tables may contain parameters that cannot be configured for a given unit.**



### General parameters – GENUNIT

Name	Status	Unit	Displayed text*	Description
CTRL_TYP	0 to 2	-	Local=0 Net.=1 Remote=2	Operating mode: 0 = Local 1 = Network 2 = Remote
STATUS	-	-	Running Status	Unit running status: Off, Stopping, Delay, Running, Ready, Override, Tripout, Test, Runtest
SGR_st	1 to 4	-	Smart Grid Ready Status	Smart Grid Ready status (operating mode): 1 = LOCK 2 = NORMAL 3 = BOOST 4 = FORCED
ALM	-	-	Alarm State	Alarm State: Normal = No alarm Partial = There is an alarm, but the unit continues to operate Shutdown = Unit shuts down
min_left	-	min	Minutes Left for Start	Minutes before the unit start-up
HEATCOOL		-	Heat/Cool status	Heating/cooling status
HC_SEL	0 to 2	-	Heat/Cool Select	Heating/cooling selection
			0=Cool. 1=Heat. 2=Auto	0 = Cooling 1 = Heating 2 = Automatic heating/cooling control
SP_SEL	0 to 2	-	Setpoint Select	Setpoint selection
			0=Auto. 1=Spt1. 2=Spt2	0 = Automatic setpoint selection 1 = Setpoint 1 (active during occupied period) 2 = Setpoint 2 (active during unoccupied period)
SP_OCC	no/yes	-	Setpoint Occupied?	Setpoint status: 0 (no) = Unoccupied 1 (yes) = Occupied
CHIL_S_S	disable/enable	-	Net.: Cmd Start/Stop	Unit start/stop via Network: When the unit is in Network mode, start/stop command can be forced
CHIL_OCC	no/yes	-	Net.: Cmd Occupied	Unit time schedule via Network: When the unit is in Network mode, the forced value can be used instead of the real occupancy state
CAP_T	0 to 100	%	Percent Total Capacity	Percent total capacity
CAPA_T	0 to 100	%	Circuit A Total Capacity	Total capacity, circuit A
CAPB_T	0 to 100	%	Circuit B Total Capacity	Total capacity, circuit B
DEM_LIM	0 to 100	%	Active Demand Limit Val	Active demand limit value: When the unit is Network mode, the minimum value will be used compared to the status of the external limit switch contact and the demand limit switch setpoint
SP	-	°C / °F	Current setpoint	Current setpoint
CTRL_PNT	-20 to 67 -4 to 153	°C °F	Control Point	Control point: Water temperature that the unit must produce
EMSTOP	disable/enable	-	Emergency Stop	Emergency stop: Used to stop the unit regardless of its active operating type

\*Depends on the selected language (French by default)



### Temperature – TEMP

Name	Status	Unit	Displayed text*	Description
EWT	-	°C / °F	Entering Water Temp	Evaporator entering water temperature: Used for capacity control
LWT	-	°C / °F	Leaving Water Temp	Evaporator leaving water temperature: Used for capacity control
OAT	-	°C / °F	Outdoor Air Temperature	Outdoor air temperature: Used to determine a number of control mechanisms such as heat/cool changeover, water exchanger heater operation, defrost cycle, free cooling option, and more
CHWSTEMP	-	°C / °F	Chiller Water System Temp	Master/Slave chiller common temperature
SCT_A	-	°C / °F	Saturated Cond Tmp A	Saturated condensing temperature, circuit A
SST_A	-	°C / °F	Saturated Suction Tmp A	Saturated suction temperature, circuit A
SUCT_A	-	°C / °F	Suction Temp Circuit A	Suction temperature, circuit A



## 5 - USER INTERFACE: MENU STRUCTURE



### Temperature – TEMP (CONTINUED)

Name	Status	Unit	Displayed text*	Description
DGT_A	-	°C / °F	Discharge Gas Temp A	Discharge gas temperature, circuit A
SCT_B	-	°C / °F	Saturated Cond Tmp B	Saturated condensing temperature, circuit B
SST_B	-	°C / °F	Saturated Suction Tmp B	Saturated suction temperature, circuit B
SUCT_B	-	°C / °F	Suction Temp Circuit B	Suction temperature, circuit B
DGT_B	-	°C / °F	Discharge Gas Temp B	Discharge gas temperature, circuit B
DEFRT_A	-	°C / °F	Defrost Temp Circuit A	Defrost temperature, circuit A (heat pumps)
DEFRT_A2	-	°C / °F	Defrost Temp A Coil 2	Defrost temperature, circuit A, coil 2
DEFRT_B	-	°C / °F	Defrost Temp Circuit B	Defrost temperature, circuit B (heat pumps)
sgtc1	-	°C / °F	Suction Gas Temp Coil 1	Suction Gas Temp Coil 1
sgtc2	-	°C / °F	Suction Gas Temp Coil 2	Suction Gas Temp Coil 2
wtot	-	°C / °F	Water Tank Output Temp	Water Tank Output Temperature

\*Depends on the selected language (French by default).



### Pressure – PRESSURE

Name	Status	Unit	Displayed text*	Description
DP_A	-	kPa / PSI	Discharge Pressure A	Compressor discharge pressure, circuit A
SP_A	-	kPa / PSI	Suction Pressure A	Compressor suction pressure, circuit A
DP_B	-	kPa / PSI	Discharge Pressure B	Compressor discharge pressure, circuit B
SP_B	-	kPa / PSI	Suction Pressure B	Compressor suction pressure, circuit B
PUMP_EWP	-	kPa / PSI	Entering Water Pressure	Pump entering water pressure
PUMP_LWP	-	kPa / PSI	Leaving Water Pressure	Pump leaving water pressure

\*Depends on the selected language (French by default).



### Setpoint – SETPOINT

Name	Status**	Default	Unit	Displayed text*	Description
csp1	-28.9 to 20	7	°C	Cooling Setpoint 1	Cooling setpoint 1
	-20.0 to 68	44.6	°F		
csp2	-28.9 to 20	7	°C	Cooling Setpoint 2	Cooling setpoint 2
	-20.0 to 68	44.6	°F		
hsp1	25.0 to 65	38	°C	Heating Setpoint 1	Heating setpoint 1
	77.0 to 149	100.4	°F		
hsp2	25.0 to 65	38	°C	Heating Setpoint 2	Heating setpoint 2
	77.0 to 149	100.4	°F		
ramp_sp	0.1 to 1.1	0.6	^C	Ramp Loading	Ramp loading setpoint
	0.2 to 2.0	1	^F		
cauto_sp	3.9 to 50	23.9	°C	Cool Changeover Setpt	Cooling changeover setpoint
	39.0 to 122.0	75	°F		
hauto_sp	0 to 46.1	17.8	°C	Heat Changeover Setpt	Heating changeover setpoint
	32.0 to 115.0	64	°F		
lim_sp1	0 to 100	100	%	Switch Limit Setpoint 1	Switch limit setpoint 1
lim_sp2	0 to 100	100	%	Switch Limit Setpoint 2	Switch limit setpoint 2
lim_sp3	0 to 100	100	%	Switch Limit Setpoint 3	Switch limit setpoint 3
min_sct	26.7 to 60	40	°C	Desuperheat Min Sct	Minimum SCT when desuperheater is enabled
	80 to 140	104	°F		

\*Depends on the selected language (French by default).

\*\*The range may vary depending on the unit configuration, e.g. fluid type.

## 5 - USER INTERFACE: MENU STRUCTURE



### Inputs – INPUTS

Name	Status	Unit	Displayed text*	Description
ONOFF_SW	open/close	-	Remote On/Off Switch	Remote on/off switch
HC_SW	open/close	-	Remote Heat/Cool Switch	Remote heating/cooling selection switch
on_ctrl	-	-	Current Control	Current control
SETP_SW	open/close	-	Second Setpoint Switch	Second setpoint selection switch
LIM_SW1	open/close	-	Limit Switch 1	Demand limit switch 1
LIM_SW2	open/close	-	Limit Switch 2	Demand limit switch 2
SP_RESET	4 to 20	mA	Setpoint Reset Signal	Setpoint Reset Signal
FLOW_SW	open/close	-	Flow Switch Interlock	Flow switch interlock
leak_v1	-	V	Leakage Detection 1	Leakage detection 1
leak_v2	-	V	Leakage Detection 2	Leakage detection 2
DSHTR_SW	open/close	-	Desuperheater switch	Desuperheater switch
HP_SW_A	open/close	-	High Pressure Switch A	High Pressure Switch A
HP_SW_A3	open/close	-	High Pressure Switch A3	High Pressure Switch A3
HP_SW_B	open/close	-	High Pressure Switch B	High Pressure Switch B
SGR0_BST	open/close	-	SG Ready #0 (Boost)	Smart Grid Ready control input (Boost)
SGR1_LCK	open/close	-	SG Ready #1 (Lock)	Smart Grid Ready control input (Lock)

\*Depends on the selected language (French by default).



### Outputs – OUTPUTS

Name	Status	Unit	Displayed text*	Description
CP_A1	off/on	-	Compressor A1	Compressor A1 command
CP_A2	off/on	-	Compressor A2	Compressor A2 command
CP_A3	off/on	-	Compressor A3	Compressor A3 command
FAN_A1LS	off/on	-	Fan A1 Low Speed	Fan A1 low speed command
FAN_A1HS	off/on	-	Fan A1 High Speed	Fan A1 high speed command
FAN_A2LS	off/on	-	Fan A2 Low Speed	Fan A2 low speed command
FAN_A2HS	off/on	-	Fan A2 High Speed	Fan A2 high speed command
VFAN_A	-	%	VariaFan Speed A	Variable fan speed A
EXV_A	0 to 100	%	EXV position Circuit A	EXV position, circuit A
EXVNPosA	-	%	EXV Next Pos Circuit A	EXV next position circuit A
RV_A	off/on	-	4-way Refrigerant Valve A	4-way refrigerant valve, circuit A: Used to manage cooling/heating/defrost operation (heat pumps)
CP_B1	off/on	-	Compressor B1	Compressor B1 command
CP_B2	off/on	-	Compressor B2	Compressor B2 command
FAN_B1LS	off/on	-	Fan B1 Low Speed	Fan B1 low speed status
FAN_B1HS	off/on	-	Fan B1 High Speed	Fan B1 high speed status
VFAN_B	-	%	VariaFan Speed B	Variable fan speed B
EXV_B	0 to 100	%	EXV position Circuit B	EXV position, circuit B
EXVNPosB	-	%	EXV Next Pos Circuit B	EXV next position circuit B
RV_B	off/on	-	4-way Refrigerant Valve B	4-way refrigerant valve, circuit B: Used to manage cooling/heating/defrost operation (heat pumps)
EXCH_HTR	off/on	-	Exchanger Heater	Exchanger heater
BOILER	off/on	-	Boiler Command	Boiler command
EHS_STEP	-	-	Electrical Heat Stage	Electrical heat stage
tnk_hpow	-	-	Water Tank EHS power	Water tank EHS power
ALARM	off/on	-	Alarm Relay	Alarm relay status
RUN	off/on	-	Running Relay	Running relay status

\*Depends on the selected language (French by default).

## 5 - USER INTERFACE: MENU STRUCTURE



### Pump Status – PUMPSTAT

Name	Status	Unit	Displayed text*	Description
PUMP_1	off/on	-	Water Pump #1	Water pump 1 control
PUMP_2	off/on	-	Water Pump #2	Water pump 2 control
ROT_PUMP	no/yes	-	Rotate Pumps Now?	Water pumps rotation
VPMP_CMD	0 to 100	%	Variable Pump Command	Variable speed pump command
W_P_IN	-	kPa / PSI	Inlet Water Pressure	Inlet water pressure (corrected by temperature): Applies to units with the hydronic kit option
W_P_OUT	-	kPa / PSI	Outlet Water Pressure	Outlet water pressure (corrected by temperature): Applies to units with the hydronic kit option
WP_CALIB	no/yes	-	Water Pressure Calibrat	Water pressure calibration
WP_OFFST	-	kPa / PSI	Water Pressure Offset	Water pressure offset
DP_FILTR	-	kPa / PSI	Delta Water Press. Filt	Delta water pressure filter
WP_MIN	-	kPa / PSI	Mini Water Pressure	Minimum water pressure
WAT_FLOW	-	l/s / GPS	Water Flow	Water flow rate
CAPPOWER	-	kW	Actual Power Capacity	Actual power capacity
p_dt_spt	-	^C / ^F	Water DT Setpoint	Water delta T setpoint
p_dp_spt	-	kPa / PSI	Water DP Setpoint	Water delta pressure setpoint

\*Depends on the selected language (French by default).



### Runtimes – RUNTIME

Name	Status	Unit	Displayed text*	Description
hr_mach	-	hour	Machine Operating Hours	Unit operating hours
st_mach	-	-	Machine Starts Number	Number of unit starts
hr_cp_a1	-	hour	Compressor A1 Hours	Operating hours, compressor A1
st_cp_a1	-	-	Compressor A1 Starts	Number of starts, compressor A1
hr_cp_a2	-	hour	Compressor A2 Hours	Operating hours, compressor A2
st_cp_a2	-	-	Compressor A2 Starts	Number of starts, compressor A2
hr_cp_a3	-	hour	Compressor A3 Hours	Operating hours, compressor A3
st_cp_a3	-	-	Compressor A3 Starts	Number of starts, compressor A3
hr_cp_b1	-	hour	Compressor B1 Hours	Operating hours, compressor B1
st_cp_b1	-	-	Compressor B1 Starts	Number of starts, compressor B1
hr_cp_b2	-	hour	Compressor B2 Hours	Operating hours, compressor B2
st_cp_b2	-	-	Compressor B2 Starts	Number of starts, compressor B2
hr_pump1	-	hour	Water Pump #1 Hours	Operating hours, water pump 1
hr_pump2	-	hour	Water Pump #2 Hours	Operating hours, water pump 2
hr_fana1	-	hour	Circuit A Fan #1 Hours	Operating hours, fan A1
st_fana1	-	-	Circuit A Fan #1 Starts	Number of starts, fan A1
hr_fana2	-	hour	Circuit A Fan #2 Hours	Operating hours, fan A2
st_fana2	-	-	Circuit A Fan #2 Starts	Number of starts, fan A2
hr_fanb1	-	hour	Circuit B Fan #1 Hours	Operating hours, fan B1
st_fanb1	-	-	Circuit B Fan #1 Starts	Number of starts, fan B1
nb_defra	-	-	Circuit A Defrost Number	Number of defrost sessions that occurred on circuit A
nb_defrb	-	-	Circuit B Defrost Number	Number of defrost sessions that occurred on circuit B

\*Depends on the selected language (French by default).

## 5 - USER INTERFACE: MENU STRUCTURE



### DC Free Cooling Status – DCFC\_STA

Name	Status	Unit	Displayed text*	Description
oat	-	°C / °F	OAT Free Cooling	Dry Cooler Free Cooling: OAT
lwt	-	°C / °F	FC Leaving Water Temp	Dry Cooler Free Cooling: Leaving water temperature
wloop	-	°C / °F	FC Water Loop Temp	Dry Cooler Free Cooling: Water loop temperature
m_dcfc	no/yes	-	Free Cooling Mode Active	Dry Cooler Free Cooling mode active
dcfc_cap	0 to 100	%	FC Capacity	Dry Cooler Free Cooling capacity
f_stage	0 to 10	-	Fix Speed Fans Stage	Dry Cooler Free Cooling: Fan stage (fixed speed fans)
vf_speed	0 to 100	%	Varifan Speed	Dry Cooler Free Cooling: Fan speed (variable speed)
pid_out	0 to 100	%	PID Output	Status of PID output
FC_HOUR	0 to 999999	hour	DCFC Operating Hours	Dry Cooler Free Cooling: Operating hours
FC_FAN1S	0 to 999999	-	DCFC Fan Stage 1 Start	DCFC / Fan stage 1: Number of starts
FC_FAN1H	0 to 999999	hour	DCFC Fan Stage 1 Hours	DCFC / Fan stage 1: Operating hours
FC_FAN2S	0 to 999999	-	DCFC Fan Stage 2 Start	DCFC / Fan stage 2: Number of starts
FC_FAN2H	0 to 999999	hour	DCFC Fan Stage 2 Hours	DCFC / Fan stage 2: Operating hours
FC_FAN3S	0 to 999999	-	DCFC Fan Stage 3 Start	DCFC / Fan stage 3: Number of starts
FC_FAN3H	0 to 999999	hour	DCFC Fan Stage 3 Hours	DCFC / Fan stage 3: Operating hours
FC_FAN4S	0 to 999999	-	DCFC Fan Stage 4 Start	DCFC / Fan stage 4: Number of starts
FC_FAN4H	0 to 999999	hour	DCFC Fan Stage 4 Hours	DCFC / Fan stage 4: Operating hours
FC_FAN5S	0 to 999999	-	DCFC Fan Stage 5 Start	DCFC / Fan stage 5: Number of starts
FC_FAN5H	0 to 999999	hour	DCFC Fan Stage 5 Hours	DCFC / Fan stage 5: Operating hours
FC_FAN6S	0 to 999999	-	DCFC Fan Stage 6 Start	DCFC / Fan stage 6: Number of starts
FC_FAN6H	0 to 999999	hour	DCFC Fan Stage 6 Hours	DCFC / Fan stage 6: Operating hours
FC_FAN7S	0 to 999999	-	DCFC Fan Stage 7 Start	DCFC / Fan stage 7: Number of starts
FC_FAN7H	0 to 999999	hour	DCFC Fan Stage 7 Hours	DCFC / Fan stage 7: Operating hours
FC_VFANS	0 to 999999	-	DCFC Variable Fan Start	DCFC / Variable speed fan: Number of starts
FC_VFANH	0 to 999999	hour	DCFC Variable Fan Hours	DCFC / Variable speed fan: Operating hours

\*Depends on the selected language (French by default).



### Miscellaneous Status – MSC\_STAT

Name	Status	Unit	Displayed text*	Description
m_ecopmp	no/yes	-	Eco Pump Mode Active	Eco pump mode status: When this mode is active, the pump is stopped periodically when the unit is in Standby

\*Depends on the selected language (French by default).



### Modes – MODES

Name	Status	Unit	Displayed text*	Description
m_delay	no/yes	-	Delay Active	Delay Active
m_2ndstpt	no/yes	-	Second Setpoint Active	Second setpoint in use: The setpoint used during unoccupied periods
m_reset	no/yes	-	Reset Active	Setpoint reset active
m_limit	no/yes	-	Demand Limit Active	Demand limit active
m_ramp	no/yes	-	Ramp Loading Active	Ramp loading active
m_cooler	no/yes	-	Cooler Heater Active	Cooler heater active
m_pmprot	no/yes	-	Pump Rot Active	Pump rotation active
m_pmpper	no/yes	-	Pump Per Active	Pump periodic active
m_night	no/yes	-	Night Low Noise Active	Night low noise active
m_SM	no/yes	-	System Manager Active	System Manager active
m_leadla	no/yes	-	Master Slave Active	Master/slave mode active
m_auto	no/yes	-	Auto Changeover Active	Automatic changeover active
m_heater	no/yes	-	Electric Heat Active	Electric heater active
m_lo_ewt	no/yes	-	Heating Low EWT Lockout	Heating low EWT lockout
m_boiler	no/yes	-	Boiler Active	Boiler active
m_defr_a	no/yes	-	Defrost Active On Cir A	Defrost mode active, circuit A (heat pumps)
m_defr_b	no/yes	-	Defrost Active On Cir B	Defrost mode active, circuit B (heat pumps)
m_sst_a	no/yes	-	Low Suction Circuit A	Low suction, circuit A
m_sst_b	no/yes	-	Low Suction Circuit B	Low suction, circuit B

## 5 - USER INTERFACE: MENU STRUCTURE



### Modes – MODES (CONTINUED)

Name	Status	Unit	Displayed text*	Description
m_dgt_a	no/yes	-	High DGT Circuit A	High DGT, circuit A
m_dgt_b	no/yes	-	High DGT Circuit B	High DGT, circuit B
m_hp_a	no/yes	-	High Pres Override Cir A	High pressure override, circuit A
m_hp_b	no/yes	-	High Pres Override Cir B	High pressure override, circuit B
m_sh_a	no/yes	-	Low SuperHeat Circuit A	Low superheat, circuit A
m_sh_b	no/yes	-	Low SuperHeat Circuit B	Low superheat, circuit B

\*Depends on the selected language (French by default).



### Quick Test 1 – QCK\_TST1

Name	Status	Unit	Displayed text*	Description
QCK_TEST	no/yes	-	Quick test Enable	This parameter is used to enable the Quick Test functionality (Quick test Enable = yes) With Quick Test enabled: Forcing a specific parameter given in this table allows the user to verify if the component behaves correctly
Q_F_A1LS	off/on	-	Fan Stage Circuit A1LS	Fan stage A1 low speed, circuit A
Q_F_A1HS	off/on	-	Fan Stage Circuit A1HS	Fan stage A1 high speed, circuit A
Q_F_A2LS	off/on	-	Fan Stage Circuit A2LS	Fan stage A2 low speed, circuit A
Q_F_A2HS	off/on	-	Fan Stage Circuit A2HS	Fan stage A2 high speed, circuit A
Q_F_B1LS	off/on	-	Fan Stage Circuit B1LS	Fan stage B1 low speed, circuit B
Q_F_B1HS	off/on	-	Fan Stage Circuit B1HS	Fan stage B1 high speed, circuit B
Q_VFANA	0 to 100	%	Variable Speed Fan A	Variable speed fan A
Q_VFANB	0 to 100	%	Variable Speed Fan B	Variable speed fan B
MOD_EXVA	manual/auto	-	QuickTest Mode for EXV A	QuickTest mode for EXV A
Q_EXVA	0 to 100	%	EXV position Circuit A	EXV position Circuit A 100% = EXV fully open
MOD_EXVB	manual/auto	-	QuickTest Mode for EXV B	QuickTest mode for EXV B
Q_EXVB	0 to 100	%	EXV position Circuit B	EXV position Circuit B 100% = EXV fully open
Q_RV_A	off/on	-	4 Way Refrigerant ValveA	4 Way refrigerant valve A
Q_RV_B	off/on	-	4 Way Refrigerant ValveB	4 Way refrigerant valve B
Q_PUMP_1	0 to 2	-	Pump 1. 1=ON 2=FORCED	Pump 1 test: 1 = [ON] Pump shall run for 16 sec 2 = [FORCED] Pump shall run all the time (set the value to "0" to stop the pump test)
Q_PUMP_2	0 to 2	-	Pump 2. 1=ON 2=FORCED	Pump 2 test: 1 = [ON] Pump shall run for 16 sec 2 = [FORCED] Pump shall run all the time (set the value to "0" to stop the pump test)
Q_VPUMP1	0 to 100	%	Variable pump 1	Variable pump 1
Q_ALARM	off/on	-	Alarm relay Status	Alarm relay status
Q_RUN	off/on	-	Running Status	Running status
Q_BOILER	off/on	-	Boiler Command	Boiler command
Q_EHS_ST	0 to 4	-	Electrical Heat Stage	Electrical heat stage
Q_EX_HTR	off/on	-	Cool & Defrost Heater A	Heater activation (this test is used to activate the cooler heater and in case of heat pumps it is used to activate the coil heater used to drain the water during the defrost cycle)
Q_FC_WV	off/on	-	FC Water Valve Outputs	FC water valve outputs
Q_FCVFSP	0 to 100	%	FC Variable Fan Speed	FC variable fan speed
Q_FC_FST	0 to 7	-	FC Fan Stage	FC fan stage
HP_TEST	-1 to 1		High Pressure Test	High Pressure test: When activated, the unit will run until the High Pressure Safety Switch is open
			-1=Off / 0=CirA / 1=CirB	-1 = off 0 = High Pressure test, circuit A 1 = High Pressure test, circuit B

\*Depends on the selected language (French by default).

**IMPORTANT: To enable the Quick Test functionality, the unit must be stopped (Local off mode).**

## 5 - USER INTERFACE: MENU STRUCTURE



### Trendings – TRENDING

Name	Status	Unit	Displayed text*	Description**
GENUNIT_CAPA_T	0 to 100	%	Cir A Total Capacity	Total capacity, circuit A
GENUNIT_CAPB_T	0 to 100	%	Cir B Total Capacity	Total capacity, circuit B
GENUNIT_CTRL_PNT	-	°C / °F	Control Point	Control point
TEMP_OAT	-	°C / °F	Outdoor Air Temp	Outdoor air temperature
TEMP_EWT	-	°C / °F	Cooler Entering Fluid	Evaporator entering water temperature
TEMP_LWT	-	°C / °F	Cooler Leaving Fluid	Evaporator leaving water temperature
TEMP_SCT_A	-	°C / °F	Saturated Cond Tmp cir A	Saturated condensing temperature, circuit A
TEMP_SCT_B	-	°C / °F	Saturated Cond Tmp cir B	Saturated condensing temperature, circuit B
TEMP_SST_A	-	°C / °F	Saturated Suction Temp A	Saturated suction temperature, circuit A
TEMP_SST_B	-	°C / °F	Saturated Suction Temp B	Saturated suction temperature, circuit B

\*Depends on the selected language (French by default).

\*\*The list of trending points cannot be modified. Trending points can only be enabled or disabled.



### Software Options – OPT\_STA

Name	Status	Unit	Displayed text*	Description
opt6	no/yes	-	OPT6: Low Brine	Parameter set to "yes" means that Low brine option which requires the Software Key is activated (see also section 6.18)
opt149	no/yes	-	OPT149: BACnet	Parameter set to "yes" means that BACnet option which requires the Software Key is activated (see also section 6.19)
opt149B	no/yes	-	OPT149B: Modbus	Modbus option is a free option and does not require a Software Activation Key (see also section 6.20)
opt5	no/yes	-	OPT5: Medium brine	Parameter set to "yes" means that Medium brine option which requires the Software Key is activated (see also section 6.18)

\*Depends on the selected language (French by default).

**NOTE: If you need to add an option, please contact your local Service provider.**



### Leakage Detector – LEAKAGE

Name	Status	Unit	Displayed text*	Description
I_date	DD/MM/YYYY	-	Maint. remind Date	Next calibration date (the leakage sensor requires annual calibration) Note: Please contact your local service agency.
LD_CAL	no/yes	no	Perform Calibration	This parameter is used to perform the calibration of leakage sensors (Service mode is required)
PerLFL_A	-	%	Flammability Limit A %	"PerLFL" (Lower Flammability Limit %) is the R32 gas concentration multiplied by 100, circuit A: <ul style="list-style-type: none"> <li>This value reading is sent by the leakage detector.</li> <li>If this "PerLFL" value measured by the sensor is above the service-configured LFL limit (15-50%), then an alarm/alert will be raised. If the local unit is stopped, then the fan(s) will start running at minimum speed to evacuate R32 gas.</li> </ul> Note: Fans will also start running in case the communication with the leakage detection sensor is lost (alert 5001). Example: 100% PerLFL is equal to 14.4% R32 volume in air (144 000 PPM)
Vol_A	-	%	R32 Volume A %	R32 volume in air, circuit A: R32 concentration by volume <ul style="list-style-type: none"> <li>This value reading is sent by the leakage detector.</li> </ul> Example: 100% PerLFL is equal to 14.4% R32 volume in air (144 000 PPM)
Temp_A	-	°C / °F	Sensor Temp A	Sensor temperature, circuit A
Gas_A	4146	-	Gas Type A	Gas type, circuit A 4146 = R32
warnA	0-xxx		Warning cond. A	Leakage detector warning, circuit A (see section 8.6.2) 0 = no warning detected
errA	0-xxx		Error cond. A	Leakage detector error, circuit A (see section 8.6.3) 0 = no error detected

## 5 - USER INTERFACE: MENU STRUCTURE



### Leakage Detector – LEAKAGE (continued)

Name	Status	Unit	Displayed text*	Description
faultA	16-37		Fault A	Leakage detector fault, circuit A 16 = the sensor is operating correctly 37 = the sensor is NOT operating correctly (the error code is generated, see "Error cond. A" above)
CalDaysA	(number of days)	-	Days since last Calib A	Number of days since the last sensor calibration
PerLFL_B	-	%	Flammability Limit B %	"PerLFL" (Lower Flammability Limit %) is the R32 gas concentration multiplied by 100, circuit B: <ul style="list-style-type: none"> <li>This value reading is sent by the leakage detector.</li> <li>If this "PerLFL" value measured by the sensor is above the service-configured LFL limit (25% by default), then an alarm/alert will be raised. If the local unit is stopped, then the fan(s) will start running at minimum speed to evacuate R32 gas.</li> </ul> Note: Fans will also start running in case the communication with the leakage detection sensor is lost (alert 5002).  Example: 100% PerLFL is equal to 14.4% R32 volume in air (144 000 PPM)
Vol_B	-	%	R32 Volume B %	R32 volume in air, circuit B: R32 concentration by volume <ul style="list-style-type: none"> <li>This value reading is sent by the leakage detector.</li> </ul> Example: 100% PerLFL is equal to 14.4% R32 volume in air (144 000 PPM)
Temp_B	-	°C / °F	Sensor Temp B	Sensor temperature, circuit B
Gas_B	4146	-	Gas Type B	Gas type, circuit B 4146 = R32
warnB	0-xxx		Warning cond. B	Leakage detector warning, circuit B (see section 8.6.2) 0 = no warning detected
errB	0-xxx		Error cond. B	Leakage detector error, circuit B (see section 8.6.3) 0 = no error detected
faultB	16-37		Fault B	Leakage detector fault, circuit B 16 = the sensor is operating correctly 37 = the sensor is NOT operating correctly (the error code is generated, see "Error cond. B" above)
CalDaysB	(number of days)	-	Days since last Calib B	Number of days since the last sensor calibration

\*Depends on the selected language (French by default).

# 5 - USER INTERFACE: MENU STRUCTURE

## 5.2 - Configuration menu

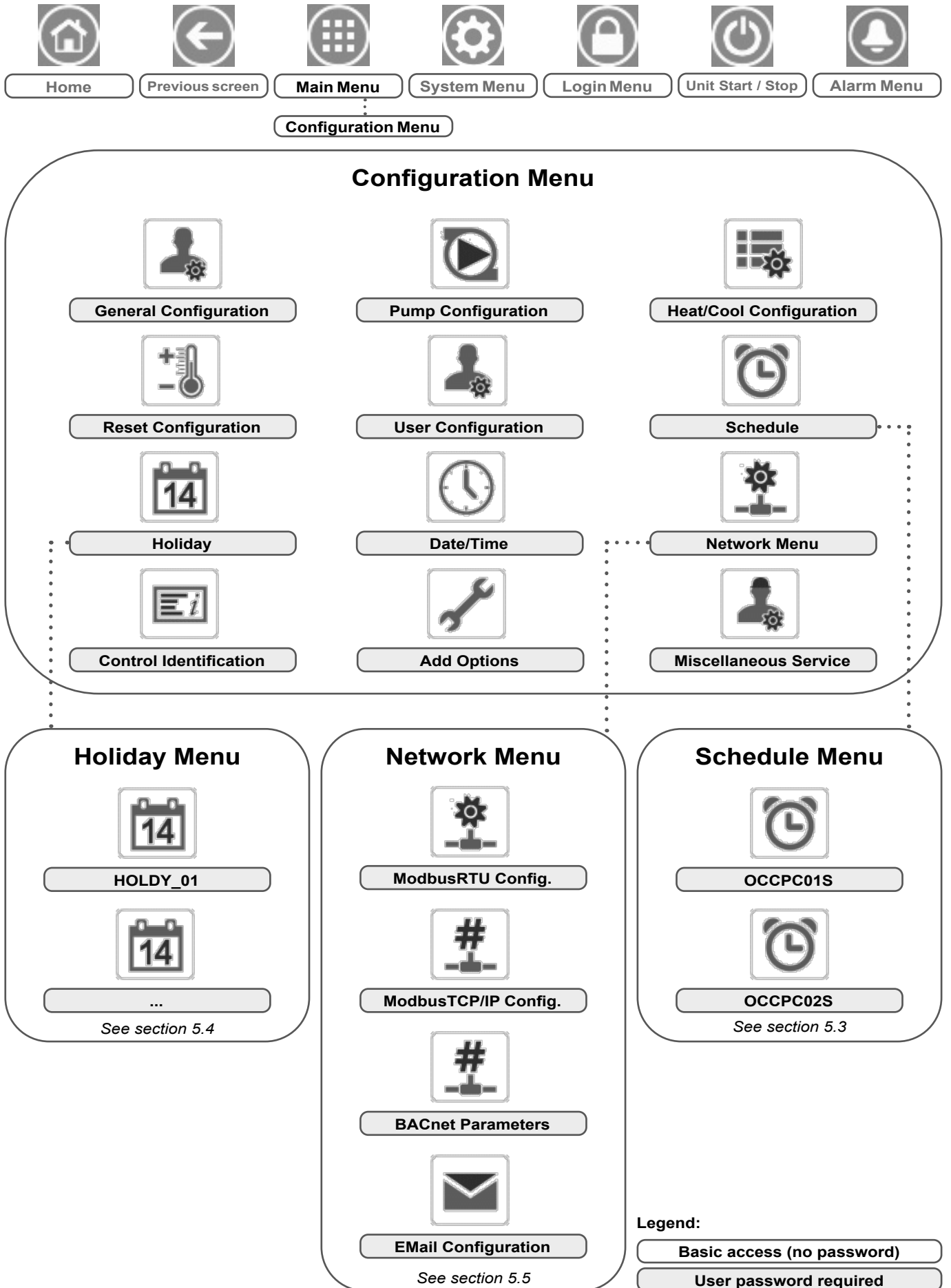



## 5 - USER INTERFACE: MENU STRUCTURE

The **Configuration menu** gives access to a number of user-modifiable parameters such as pump configuration, schedule menu, etc. The Configuration menu is password-protected.

- To access the Configuration menu, press the **Main menu** button located in the upper-left part of the Home screen, and then select **Configuration Menu**.
- Once all the necessary modifications have been made, press the **Save** button to confirm your changes or the **Cancel** button to exit the screen without making modifications.

**System configuration override:** In some cases it is possible to override system configuration. Note that not all parameters can be overridden by the control.

**CAUTION:** *Since specific units may not include additional features, some tables may contain parameters that cannot be configured for a given unit.*



### General Configuration – GENCONF

Name	Status	Default	Unit	Displayed text*	Description
lead_cir	0 to 2	0	-	Cir Priority Sequence 0=Auto 1=A Lead 2=B Lead	Circuit priority 0 = Automatic circuit selection 1 = Circuit A lead 2 = Circuit B lead
seq_typ	no/yes	no	-	Staged Loading Sequence	Staged loading sequence
ramp_sel	no/yes	no	-	Ramp Loading Select	Ramp loading selection
off_on_d	1 to 15	1	min	Unit Off to On Delay	Unit off to on delay
nh_limit	0 to 100	100	%	Night Capacity Limit	Night capacity limit
nh_start	-	-	-	Night Mode Start Hour	Night mode start hour
nh_end	-	-	-	Night Mode End Hour	Night mode end hour
ewt_opt	no/yes	yes	-	Entering Fluid Control	Entering fluid control option (if selected, the system controls unit capacity based on the entering fluid temperature; otherwise the control is based on the leaving fluid temperature)

\*Depends on the selected language (French by default).



### Pump Configuration – PUMPCONF

Name	Status	Default	Unit	Displayed text*	Description
pump_seq	0 to 4	0	-	Cooler Pumps Sequence 0 = No Pump 1 = One Pump Only 2 = Two Pumps Auto 3 = Pump#1 Manual 4 = Pump#2 Manual	Cooler pumps sequence 0 = No pump 1 = One pump only (units with one pump) 2 = Two pumps automatic control 3 = Pump 1 selected (units with two pumps) 4 = Pump 2 selected (units with two pumps)
pump_del	24 to 3000	48	hour	Pump Auto Rotation Delay	Pump automatic rotation delay
pump_per	no/yes	no	-	Pump Sticking Protection	Pump sticking protection
pump_sby	no/yes	no	-	Stop Pump During Standby	Pump stop when the unit is in standby
pump_loc	no/yes	yes	-	Flow Checked if Pump Off	Flow checked if pump is off
water_ct	0 to 2	1	-	Water Flow Ctrl Method  0 none, 1 delta T, 2 Prs	Water flow control method  0 = none 1 = water flow control based on delta temperature 2 = water flow control based on pressure
w_dtCspt	3.0 to 9.0 5.4 to 16.2	5.0 9.0	^C ^F	Cooling Water Delta T SP	Cooling: Delta temperature setpoint
w_dpCspt	50.0 to 300.0 7.25 to 43.51	200.0 29.0	kPa PSI	Cooling Water Delta P SP	Cooling: Delta pressure setpoint
w_dtHspt	50.0 to 300.0 7.25 to 43.51	200.0 29.0	kPa PSI	Heating Water Delta T SP	Heating: Delta temperature setpoint
w_dtHspt	50.0 to 300.0 7.25 to 43.51	200.0 29.0	kPa PSI	Heating Water Delta P SP	Heating: Delta pressure setpoint
wpmp_min	50 to 100	50	%	Pump Minimum Speed	Minimum pump speed
wpmp_max	50 to 100	100	%	Pump Maximum Speed	Maximum pump speed
w_z_val	-99.0 to 10.0 -14.4 to 1.45	-99.0 -14.4	kPa PSI	Water Press Zero P2-P1	Water pressure zero (P2 - P1)
MinWpThr	70.0 to 1000.05 10.15 to 145.04	100.0 14.5	kPa PSIG	Min Water Press Thres	Minimum water pressure threshold
WtPmpMxP	96.5 to 551.6 14.0 to 80.0	500.0 72.52	kPa PSIG	Water Pump Max Delta P	Maximum water pump delta pressure
pg_evsp	-20 to 20	1.2	-	Prop PID gain EVSP Ctrl	Proportional PID gain: External Variable Speed Pump (EVSP) control
ig_evsp	-5 to 5	0.2	-	Int PID gain EVSP Ctrl	Integral PID gain: EVSP control
dg_evsp	-20 to 20	0.4	-	Deri PID gain EVSP Ctrl	Derivative PID gain: EVSP control

## 5 - USER INTERFACE: MENU STRUCTURE



### Pump Configuration – PUMPCONF (continued)

Name	Status	Default	Unit	Displayed text*	Description
min_evsp	0 to 100	50	%	Min Speed EVSP Control	Minimum speed: EVSP control
max_evsp	0 to 100	100	%	Max Speed EVSP Control	Maximum speed: EVSP control

\*Depends on the selected language (French by default).



### Heat/Cool Configuration – HCCONFIG

Name	Status	Default	Unit	Displayed text*	Description
auto_sel	no/yes	no	-	Auto Changeover Select	Auto changeover select
cr_sel	0 to 3	0	-	Cooling Reset Select	Cooling reset select
hr_sel	0 to 3	0	-	Heating Reset Select	Heating reset select
			-	1=OAT, 0=None	1=OAT, 0=none
			-	2=Delta T, 3=4-20mA	2=delta T, 3=4-20mA
heat_th	-20.0 to 0 -4.0 to 32.0	-15.0 5.0	°C °F	Heating OAT Threshold	Heating OAT threshold
boil_th	-15.0 to 15.0 5.0 to 59.0	-9.9 14.2	°C °F	Boiler OAT Threshold	Boiler OAT threshold
ehs_th	-5.0 to 21.1 23.0 to 70.0	5.0 41.0	°C °F	Elec Stage OAT Threshold	Elec stage OAT threshold
both_sel	no/yes	no	-	HSM Both Command Select	<i>Not available</i>
ehs_back	no/yes	no	-	1 Elec Stage For Backup	1 Elec stage for backup
ehs_pull	0 to 60	0	min	Electrical Pulldown Time	Electrical pulldown time
ehs_defr	no/yes	no	-	Quick EHS For Defrost	Quick EHS for defrost
tnk_plim	-	100	kW	Tank EHS Power Limit	Tank EHS power limit
tnk_alrt	no/yes	no	-	Tank EHS Efficiency Alrt	Tank EHS efficiency alert
ht_sgr	-20 to 0 -4 to 32	-15.0 5.0	°C °F	SGR Boiler OAT Thres	Smart Grid Ready option: Boiler OAT threshold

\*Depends on the selected language (French by default).



### Reset Configuration – RESETCFG

Name	Status	Default	Unit	Displayed text*	Description
			-	COOLING RESET	COOLING RESET
oat_crno	-10.0 to 51.7 14.0 to 125.0	-10.0 14.0	°C °F	OAT No Reset Value	OAT no reset value
oat_crfu	-10.0 to 51.7 14.0 to 125.0	-10.0 14.0	°C °F	OAT Full Reset Value	OAT full reset value
dt_cr_no	0 to 13.9 0 to 25.0	0 0	^C ^F	Delta T No Reset Value	Delta T no reset value
dt_cr_fu	0 to 13.9 0 to 25.0	0 0	^C ^F	Delta T Full Reset Value	Delta T full reset value
l_cr_no	0 to 20	0	mA	Current No Reset Value	Current no reset value
l_cr_fu	0 to 20	0	mA	Current Full Reset Value	Current full reset value
cr_deg	-16.7 to 16.7 -30 to 30.0	0 0	^C ^F	Cooling Reset Deg. Value	Cooling reset deg. value
			-	HEATING RESET	HEATING RESET
oat_hrno	-10.0 to 51.7 14.0 to 125.0	-10.0 14.0	°C °F	OAT No Reset Value	OAT no reset value
oat_hrfu	-10.0 to 51.7 14.0 to 125.0	-10.0 14.0	°C °F	OAT Full Reset Value	OAT full reset value
dt_hr_no	0 to 13.9 0 to 25.0	0 0	^C ^F	Delta T No Reset Value	Delta T no reset value
dt_hr_fu	0 to 13.9 0 to 25.0	0 0	^C ^F	Delta T Full Reset Value	Delta T full reset value
l_hr_no	0 to 20	0	mA	Current No Reset Value	Current no reset value
l_hr_fu	0 to 20	0	mA	Current Full Reset Value	Current full reset value
hr_deg	-16.7 to 16.7 -30 to 30.0	0 0	^C ^F	Heating Reset Deg. Value	Heating reset deg. value
				Smart Grid Ready Option	Smart Grid Ready option
heat_sg3	0 to 77.8 0 to 140	0 0	^C ^F	Boost Heat Offset	Smart Grid Ready: Heating offset (BOOST mode)

## 5 - USER INTERFACE: MENU STRUCTURE



### Reset Configuration – RESETCFG (continued)

Name	Status	Default	Unit	Displayed text*	Description
cool_sg3	0 to 77.8 0 to 140	0	^C ^F	SG Ready Heat Offset	Smart Grid Ready: Heating offset (BOOST mode)
heat_sg4	0 to 77.8 0 to 140	0	^C ^F	SG Ready Heat Offset	Smart Grid Ready: Heating offset (FORCED mode)
cool_sg4	0 to 77.8 0 to 140	0	^C ^F	SG Ready Cool Offset	Smart Grid Ready: Cooling offset (FORCED mode)

\*Depends on the selected language (French by default).  
– USERCONF



User Configuration

Name	Status	Default	Unit	Displayed text*	Description
alert_r	no/yes	no	-	Alarm Relay for Alerts?	Alarm relay for alerts?
al_rever	0 to 1	0	-	Reversed Alarm Relay	Reversed alarm relay
leak_alm	no/yes	no		Leakage alarm? (159C)	Applicable to units fitted with the optional leakage detector (option 159C): Setting "Leakage alarm? (159C)" to "yes" means that the compressor in the specific circuit will be stopped in case of leakage detection (see alarm 10227 for circuit A, alarm 10228 for circuit B)

\*Depends on the selected language (French by default).



### Date/Time – DATETIME

Displayed text*		Status	Description
Connect Touch	Connect Touch 2.0		
Daylight Saving Time	-	on/off	Summer/winter time activation
Location	Location	UTC	Time zone (Connect Touch 2.0: Time zone setting includes DST control)
Date/Time	Date/Time	YYYY/MM/DD, HH:MM:SS	Current date and time (must be set manually)
Today is a Holiday	Today is a Holiday	no/yes	Information about holidays (read-only). Please note that holidays are set in the Holiday menu (see also section 5.4)
Tomorrow is a Holiday	Tomorrow is a Holiday	no/yes	Information about the upcoming holiday period (read-only). Please note that holidays are set in the Holiday menu (see also section 5.4)

\*Depends on the selected language (French by default).

**NOTE: The Date/Time Configuration menu appears also in the System menu (see also section 5.6).**



### Control Identification – CTRLID

Status	Default	Displayed text*	Description
1-239	1	Element Number	Element number
0-239	0	Bus Number	Bus number
9600 / 19200 / 38400	9600	Baud Rate	Communication speed
-	LD_ILD_R	Device Description	Device description
-	-	Location Description	Location description
-	ECG-SR-20V4H010	Software Version	Software version
-	-	Serial Number	Serial number (MAC address)

\*Depends on the selected language (French by default).



### Add Options – ADD\_OPT

Displayed text*	Description
MAC address	Controller MAC address: This MAC address is requested by service technician when ordering any software-protected option (see also section 6.22)
Please Enter Your Software Activation Key:	Software Activation Key provided by service technician (see also section 6.22)
Unit must be OFF	The unit should not be operating when installing the Software Activation Key

\*Depends on the selected language (French by default).

**NOTE: If you need to add an option, please contact your local Service provider.**

## 5 - USER INTERFACE: MENU STRUCTURE

---



### Miscellaneous Service – MSC\_SERV

Name	Status	Default	Unit	Displayed text*	Description
				ECO PUMP CONFIG	Eco pump configuration
eco_pmp	no/yes	yes	-	Eco Pump Enable	Eco pump enable
ecop_off	2 to 60	5	min	Eco Pump Mode Off Delay	Eco pump mode off delay
ecop_on	2 to 60	2	min	Eco Pump Mode On Delay	Eco pump mode on delay
ecop_var	50 to 100	50	%	Eco Var Pump Min Speed	Eco variable pump min speed

\*Depends on the selected language (French by default)

## 5 - USER INTERFACE: MENU STRUCTURE

### 5.3 - Schedule menu

The Schedule menu includes two time schedules, where the first one (OCCPC01S) is used to control the unit start/stop and the second one (OCCPC02S) is used to control the dual setpoint.



#### Schedule – SCHEDULE

Icon	Name	Displayed text*	Description
	OCCPC01S	OCCPC01S - Schedule Menu	Unit on/off time schedule
	OCCPC02S	OCCPC02S - Schedule Menu	Unit setpoint selection time schedule

\*Depends on the selected language (French by default).

Example: Setting occupancy schedule (Connect Touch 2.0)

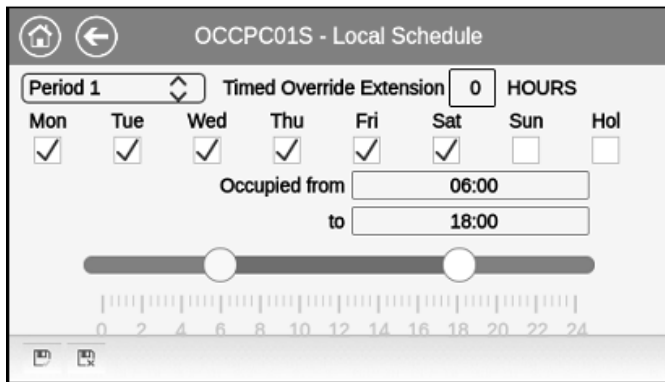

**IMPORTANT:** For more information about schedule setting, please see section 6.23.

### 5.4 - Holiday menu

The Holiday menu allows the user to set up to 16 holiday periods, which are defined by the start month, start day, and duration.



#### Holiday – HOLIDAY

Icon	Name	Displayed text*	Description
	HOLDY_01	HOLIDAY - HOLDY_01	Holiday period No.1 settings
	...	...	...
	HOLDY_16	HOLIDAY - HOLDY_16	Holiday period No.16 settings

\*Depends on the selected language (French by default).



#### Holiday - HOLDY\_01 (...)

Name	Status	Default	Displayed text*	Description
HOL_MON	0-12	0	Holiday Start Month	Holiday start month
HOL_DAY	0-31	0	Start Day	Holiday start day
HOL_LEN	0-99	0	Duration (days)	Holiday duration (days)

\*Depends on the selected language (French by default).

**IMPORTANT:** For more information about holiday setting, please see section 6.24.

## 5 - USER INTERFACE: MENU STRUCTURE

### 5.5 - Network menu

The Network menu allows the user to change network setting for BACnet/Modbus and define e-mail accounts used for alarm notifications (see section 8.3)



#### Network Menu – NETWORK

Icon	Name	Displayed text*	Description
	MODBUSRS	ModbusRTU Config.	Modbus RTU configuration
	MODBUSIP	ModbusTCP/IP Config.	Modbus TCP/IP configuration



#### Network Menu – NETWORK

Icon	Name	Displayed text*	Description
	BACnet	BACnet Parameters	BACnet standard configuration
	EMAILCFG	E-Mail Configuration	Email settings

\*Depends on the selected language (French by default).



#### ModbusRTU Configuration – MODBUSRS

Name	Status	Default	Unit	Displayed text*	Description
modrt_en	no/yes	no	-	RTU Server Enable	RTU server enable
ser_UID	1 to 247	1	-	Server UID	Server UID
metric	no/yes	yes	-	Metric Unit	Metric unit
swap_b	0 to 1	0	-	Swap Bytes	Swap bytes
				0 = Big Endian	0 = big endian
				1 = Little Endian	1 = little endian
baudrate	0 to 2	0	-	Baudrate	Baudrate
				0 = 9600	0 = 9600
				1 = 19200	1 = 19200
				2 = 38400	2 = 38400
parity	0 to 2	0	-	Parity	Parity
				0 = No parity	0 = no parity
				1 = Odd parity	1 = odd parity
				2 = Even parity	2 = even parity
stop_bit	0 to 1	0	-	Stop bit number	Stop bit number
				0 = One stop bit	0 = one stop bit
				1 = Two stop bit	1 = two stop bit
real_typ	0 to 1	1	-	Real type management	Real type management
				0 = Float X10	0 = float X10
				1 = IEE 754	1 = IEE 754
reg32bit	0 to 1	1	-	Enable 32 bits registers	Enable 32 bits registers
				0 = IR/HR in 16 bit mode	0 = IR/HR in 16 bit mode
				1 = IR/HR in 32 bit mode	1 = IR/HR in 32 bit mode

\*Depends on the selected language (French by default).



#### ModbusTCP/IP Configuration – MODBUSIP

Name	Status	Default	Unit	Displayed text*	Description
modip_en	no/yes	no	-	TCP/IP Server Enable	TCP/IP server enable
ser_UID	1 to 247	1	-	Server UID	Server UID
port_nbr	0 to 65535	502	-	Port Number	Port number
metric	no/yes	yes	-	Metric Unit	Metric unit
swap_b	0 to 1	0	-	Swap Bytes	Swap bytes
				0 = Big Endian	0 = big endian
				1 = Little Endian	1 = little endian
real_typ	0 to 1	1	-	Real type management	Real type management
				0 = Float X10	0 = float X10
				1 = IEE 754	1 = IEE 754
reg32bit	0 to 1	1	-	Enable 32 bits registers	Enable 32 bits registers
				0 = IR/HR in 16 bit mode	0 = IR/HR in 16 bit mode

## 5 - USER INTERFACE: MENU STRUCTURE



### ModbusTCP/IP Configuration – MODBUSIP

Name	Status	Default	Unit	Displayed text*	Description
				1 = IR/HR in 32 bit mode	1 = IR/HR in 32 bit mode
conifnam	0 to 1	0	-	IP port interface name	IP port interface name
				0 = J5 / J15	0 = J5 / J15
				1 = J16	1 = J16
timeout	60 to 600	120	sec	Com. timeout (s)	Com. timeout (s)
idle	0 to 30	10	sec	Keepalive idle delay(s)	Keepalive idle delay(s)
intrvl	0 to 2	1	sec	Keepalive interval(s)	Keepalive interval(s)
probes	0 to 10	10	-	Keepalive probes nb	Keepalive probes number

\*Depends on the selected language (French by default).



### BACnet Parameters – BACNET

Name	Status	Default	Unit	Displayed text*	Description
bacena	disable/enable	disable	-	BACnet Enable	BACnet enable
bacunit	no/yes	yes	-	Metric Unit?	Metric unit?
network	1 to 40000	1600	-	Network	Network
udpport	47808 to 47823	47808	-	UDP Port Number	UDP port number
bac_id	1 to 4194302	1600001	-	Device Id manual	Device id manual
aid_opt	disable/enable	disable	-	Device Id Auto Option	Device id auto option
balmena	disable/enable	enable	-	Alarm reporting	Alarm reporting
mng_occ	no/yes	no	-	BACnet Manage Occupancy	BACnet manage occupancy
conifnam	0 to 1	0	-	IP port interface name	IP port interface name
				0 = J5 / J15	0 = J5 / J15
				1 = J16	1 = J16

\*Depends on the selected language (French by default).

**NOTE: If you need to add an option, please contact your local Service provider.**



### Email Configuration – EMAILCFG

Name	Status	Default	Unit	Displayed text*	Description
senderP1			-	Sender E-mail Part1	Sender e-mail, identifier part
				@	@
senderP2			-	Sender E-mail Part2	Sender e-mail, domain part
recip1P1			-	Recip1 E-mail Part1	Recipient 1, identifier part
				@	@
recip1P2			-	Recip1 E-mail Part2	Recipient 1, domain part
recip2P1			-	Recip2 E-mail Part1	Recipient 2, identifier part
				@	@
recip2P2			-	Recip2 E-mail Part2	Recipient 2, domain part
smtpP1	0 to 255	0	-	SMTP IP Addr Part 1	SMTP IP address part 1
smtpP2	0 to 255	0	-	SMTP IP Addr Part 2	SMTP IP address part 2
smtpP3	0 to 255	0	-	SMTP IP Addr Part 3	SMTP IP address part 3
smtpP4	0 to 255	0	-	SMTP IP Addr Part 4	SMTP IP address part 4
accP1			-	Account E-mail Part1	Account e-mail, identifier part
				@	@
accP2			-	Account E-mail Part2	Account e-mail, domain part
accPass			-	Account Password	Account password
portNbr	0 to 65535	25	-	Port Number	Port number
srvTim	0 to 255	30	sec	Server Timeout	Server timeout
srvAut	0 to 1	0	-	Server Authentication	Server authentication

\*Depends on the selected language (French by default).

## 5 - USER INTERFACE: MENU STRUCTURE

### 5.6 - System menu

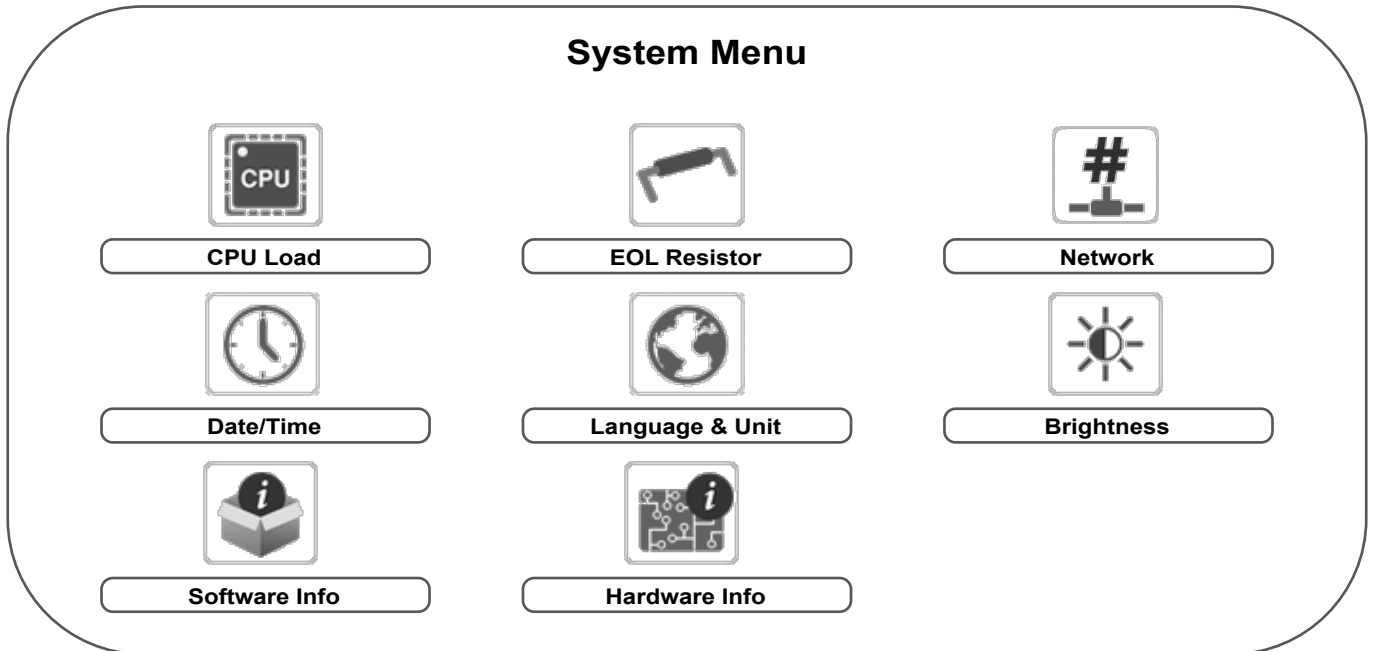

**Legend:**



The **System menu** allows the user to verify software, hardware, or network information and change some display settings, including language, date/time, or brightness. The list of configuration parameters may vary depending on the model of the touch screen.

**CAUTION:** Since specific units may not include additional features, some tables may contain parameters that cannot be configured for a given unit.

- To access the System menu, press the **System menu** button located in the upper-right part of the Home screen.



**CPU Load – CPULOAD**

Status	Default	Unit	Displayed text*	Description
0 to 100	-	%	CPU load	CPU utilization
0 to 100	-	%	RAM Memory utilization	RAM usage
0 to 100	-	%	FLASH Memory utilization	Flash memory usage

\*Depends on the selected language (French by default).



**EOL Resistor – EOLRES (not used on Connect Touch 2.0)**

Status	Default	Displayed text*	Description
disable/enable	disable	End of Line Res. J6 (LEN)	End of line resistor J6 (LEN bus)
disable/enable	disable	End of Line Res. J7	End of line resistor J7
disable/enable	disable	End of Line Resistor J8	End of line resistor J8
disable/enable	disable	End of Line Resistor J10	End of line resistor J10 (Modbus)

\*Depends on the selected language (French by default).



## 5 - USER INTERFACE: MENU STRUCTURE



### Network – NETWORK

Displayed text*		Status	Description															
Connect Touch	Connect Touch 2.0																	
IP Network Interface J5 (eth0):	<b>Ethernet 0 (J5)</b>		IP network interface J5 (Ethernet 0):															
MAC Address	MAC Address	xx:xx:xx:xx:xx:xx	MAC address															
-	DHCP	disabled	DHCP															
TCP/IP Address	IP Address	169.254.1.1	TCP/IP Address: Changing the IP address and mask is possible but a reboot is mandatory if Modbus TCP or BACnet IP is enabled (the reboot is required to make changes effective).															
Subnet Mask	Subnet Mask	255.255.255.0	Subnet mask															
Default Gateway	Default Gateway	169.254.1.3	Default gateway															
Gateway Dest/Mask	Gateway Dest/Mask	169.254.0.0/16	Gateway mask in CIDR format  <table border="1"> <thead> <tr> <th>Gateway IP address</th> <th>CIDR notation</th> <th>Gateway in CIDR format</th> </tr> </thead> <tbody> <tr> <td>169.254.1.3</td> <td>xxx.xxx.xxx.0/24</td> <td>169.254.1.0/24</td> </tr> <tr> <td>169.254.1.3</td> <td>xxx.xxx.0.0/16</td> <td>169.254.0.0/16</td> </tr> <tr> <td>169.254.1.3</td> <td>xxx.0.0.0/8</td> <td>169.0.0.0/8</td> </tr> <tr> <td>0.0.0.0</td> <td>0.0.0.0/0</td> <td>0.0.0.0/0</td> </tr> </tbody> </table> Note: "xxx" shown in the CIDR notation above refers to the Gateway IP address.	Gateway IP address	CIDR notation	Gateway in CIDR format	169.254.1.3	xxx.xxx.xxx.0/24	169.254.1.0/24	169.254.1.3	xxx.xxx.0.0/16	169.254.0.0/16	169.254.1.3	xxx.0.0.0/8	169.0.0.0/8	0.0.0.0	0.0.0.0/0	0.0.0.0/0
Gateway IP address	CIDR notation	Gateway in CIDR format																
169.254.1.3	xxx.xxx.xxx.0/24	169.254.1.0/24																
169.254.1.3	xxx.xxx.0.0/16	169.254.0.0/16																
169.254.1.3	xxx.0.0.0/8	169.0.0.0/8																
0.0.0.0	0.0.0.0/0	0.0.0.0/0																
Domain Name Server (DNS)	<b>DNS: Primary DNS</b>	169.254.1.3	Domain name server (DNS), primary address															
-	<b>DNS: Alternate DNS</b>	169.254.1.4	Domain name server (DNS), secondary address															

\*Depends on the selected language (French by default).



### Date/Time – DATETIME

Displayed text*		Status	Description
Connect Touch	Connect Touch 2.0		
Daylight Saving Time	-	on/off	Summer/winter time activation
Location	Location	UTC	Time zone (Connect Touch 2.0: Time zone setting includes DST control)
Date/Time	Date/Time	YYYY/MM/DD, HH:MM:SS	Current date and time (must be set manually)
Today is a Holiday	Today is a Holiday	no/yes	Information about holidays (read-only). Please note that holidays are set in the Holiday menu (see also section 5.4)
Tomorrow is a Holiday	Tomorrow is a Holiday	no/yes	Information about the upcoming holiday period (read-only). Please note that holidays are set in the Holiday menu (see also section 5.4)

\*Depends on the selected language (French by default).

**NOTE: The Date/Time Configuration menu appears also in the Configuration menu (see also section 5.2).**

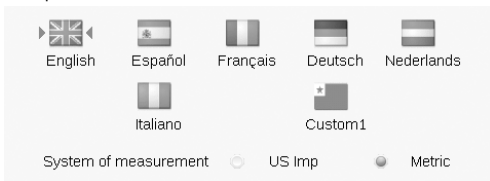

### Language & Unit – LANGUNIT

Displayed text*	Description
(Languages) Example: Connect Touch 	<b>Language selection:</b> English, Spanish, French, German, Dutch, Italian and Custom1  <b>Custom language (Custom1):</b> The control system allows users to add new languages to the control. To learn more about language customization, please contact your local Service representative. Custom languages can be uploaded only by Service representative.
System of measurement: US Imp/Metric	US Imp = Parameters displayed in US Imperial units Metric = Parameters displayed in metric units

\*Depends on the selected language (French by default).

## 5 - USER INTERFACE: MENU STRUCTURE



### Brightness – BRIGHTNS

Displayed text*		Status	Description
Connect Touch	Connect Touch 2.0		
Brightness	Brightness	0 to 100%	Screen brightness
-	Theme Selection	Dark/Light	Theme selection (Dark theme / Light theme)

\*Depends on the selected language (French by default).



### Software Info – SWINFO

Displayed text*		Status	Description
Connect Touch	Connect Touch 2.0		
Software Version	Software Version	ECG-SR-20V4H010	Software version number
SDK Version	SDK Version	N.NNN.N	SDK version number
-	App version	NN.N	Application version
UI Version	UI Version	NN	User interface version
Brand	Brand	CIAT	Brand name

\*Depends on the selected language (French by default).



### Hardware Info – HWINFO

Status	Displayed text*	Description
-	Board Variant	Board variant
-	Board Revision	Board revision
43	Screen size	Screen size in inches (4.3")

\*Depends on the selected language (French by default).

# 5 - USER INTERFACE: MENU STRUCTURE

## 5.7 - Login menu

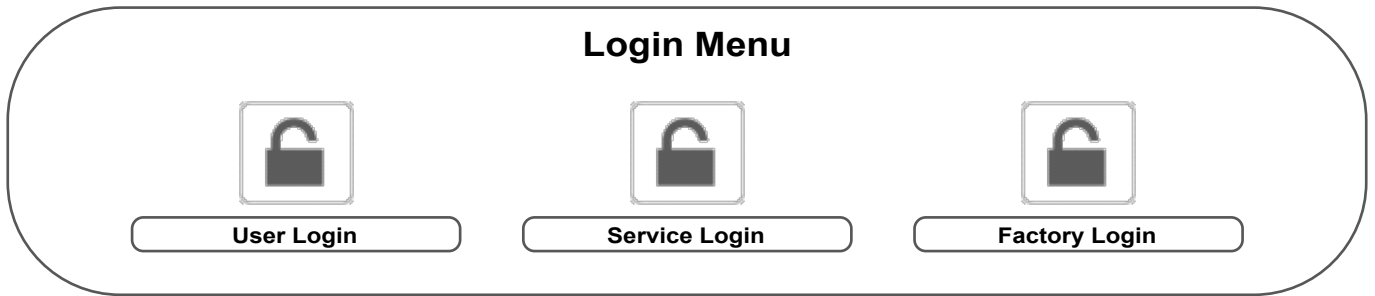

**Legend:**

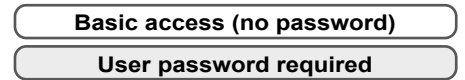

### 5.7.1 - Access control

- Login menu provides access to three different access levels, i.e. user configuration, service configuration, and factory configuration.
- Multilevel security ensures that only authorised users are allowed to modify critical unit parameters.
- Only people qualified to manage the unit should be familiarized with the password.
- Configuration menu can be accessed only by logged-in users (user configuration level or higher).

**IMPORTANT: It is strongly recommended to change the default password of the user interface to exclude the possibility of changing any parameters by an unqualified person.**

### 5.7.2 - User login

Only logged-in users can access configurable unit parameters. By default, user password is "11".

**To log in**

1. Press the **Login** button, and then select *User Login*.
2. Press the Password box.
3. Provide the password (11) and press the **Confirm** button.

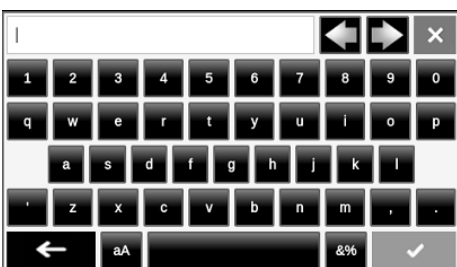

4. The User Login screen appears.

### 5.7.3 - User password

User password can be modified in the User Login menu.

**To change your password**

1. Press the **Login** button, and then select *User Login*.
2. Press the **Change User Password** button.



3. The **Change User Password** screen will be displayed.
4. Please provide the current password, and then type the new password twice.
5. Press the **Save** button to confirm password update or the **Cancel** button to exit the screen without making modifications.

### 5.7.4 - Service & Factory login

Service and factory login menu are dedicated to Service technicians and factory line. To learn more about advanced access control, please refer to the Control Service Guide (service technicians only).

# 5 - USER INTERFACE: MENU STRUCTURE

## 5.8 - Start / stop menu



### 5.8.1 - Unit operating mode

**With the unit in the Local off mode:** To display the list of operating modes and select the required mode, press the **Start/Stop** button in the upper-right corner of the Synoptic screen.



**IMPORTANT:** When entering the menu, please note that the currently selected item corresponds to the last running operating mode.

Unit start/stop screen (operating modes)	
<b>Local On</b>	Local On: The unit is in the local control mode and allowed to start.
<b>Local Schedule</b>	Local Schedule: The unit is in the local control mode and allowed to start if the period is occupied.
<b>Network</b>	Network: The unit is controlled by network commands and allowed to start if the period is occupied.
<b>Remote</b>	Remote: The unit is controlled by external commands and allowed to start if the period is occupied.
<b>Master</b>	Master: The unit operates as the master in the master/slave assembly and it is allowed to start if the period is occupied.

### 5.8.2 - Unit start

#### To start the unit

1. Press the **Start/Stop** button.
2. Select the required Machine Mode.
  - Local On
  - Local Schedule
  - Network
  - Remote
  - Master (*Master button is displayed if Master/Slave Enable*)
3. The Home screen will be displayed.

### 5.8.3 - Unit stop

#### To stop the unit

1. Press the **Start/Stop** button.
2. Confirm the unit shutdown by pressing **Confirm Stop** or cancel the unit shutdown by pressing the **Back** button.

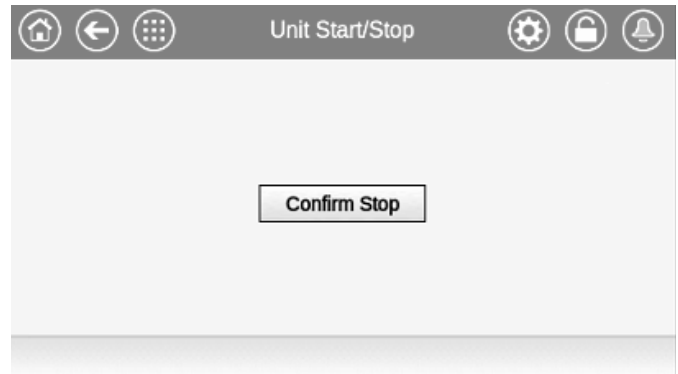

# 5 - USER INTERFACE: MENU STRUCTURE

## 5.9 - Alarms menu

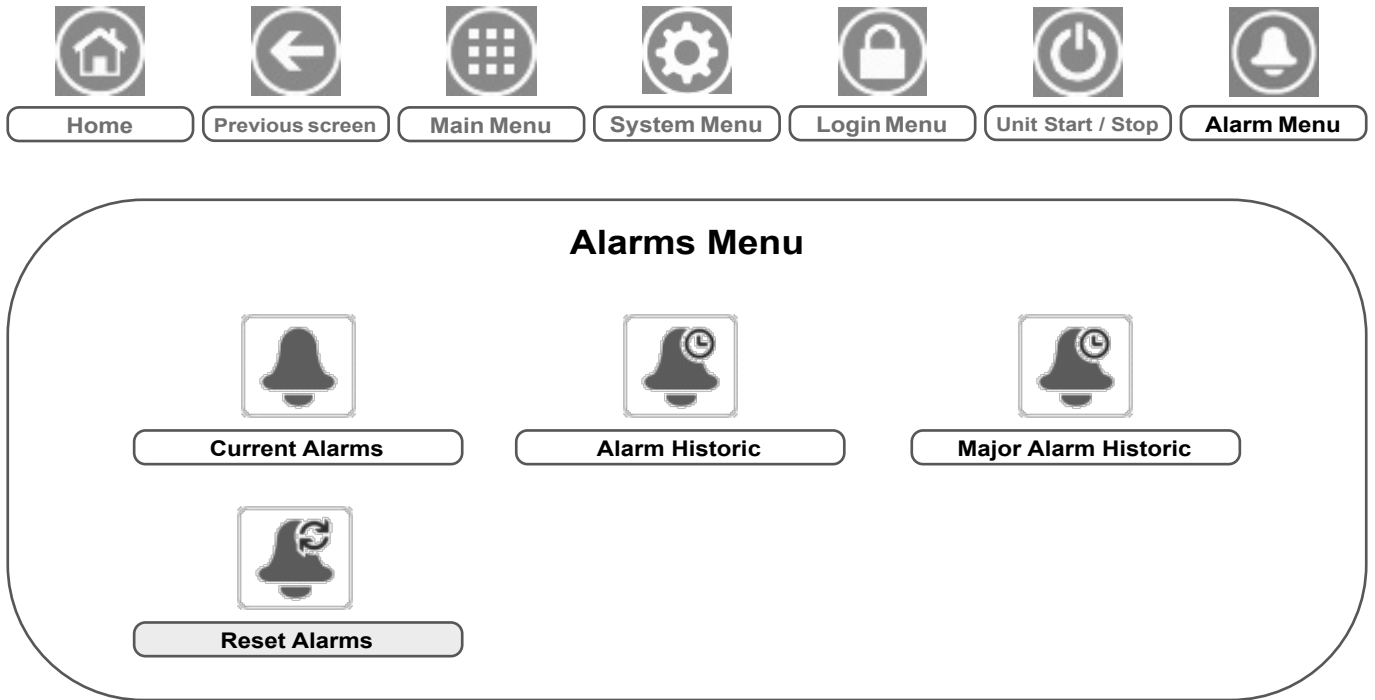

**Legend:**

- Basic access (no password)
- User password required

The **Alarms menu** allows the user to monitor alarms that occurred on the unit as well as reset alarms that require manual reset.

- To access the Alarms menu, press the **Alarms menu** button located in the upper-right part of the Home screen.

**The Alarm history is divided into two parts:**

- Alarm Historic that displays up to 50 recent general alarms.
- Major Alarm Historic that displays up to 50 recent alarms, including alarms connected with process failure, compressor failure, and VFD drives.

**IMPORTANT:** For more information about alarms, please go to section 8.6.



**Current Alarms – ALAM\_CUR**

Name	Date	Hour	Alarm text
Alarm	YYYY/MM/DD	HH:MM	Alarm text (see section 8.6)
Alarm	YYYY/MM/DD	HH:MM	Alarm text (see section 8.6)
Alarm	YYYY/MM/DD	HH:MM	Alarm text (see section 8.6)

\*Depends on the selected language (French by default).



**Alarm Historic – ALARHIST**

Name	Date	Hour	Alarm text
Alarm	YYYY/MM/DD	HH:MM	Alarm text (see section 8.6)
Alarm	YYYY/MM/DD	HH:MM	Alarm text (see section 8.6)
Alarm	YYYY/MM/DD	HH:MM	Alarm text (see section 8.6)

\*Depends on the selected language (French by default).

## 5 - USER INTERFACE: MENU STRUCTURE



### Major Alarm Historic – ALARHIS2

Name	Date	Hour	Alarm text
Alarm	YYYY/MM/DD	HH:MM	Alarm text (see section 8.6)
Alarm	YYYY/MM/DD	HH:MM	Alarm text (see section 8.6)
Alarm	YYYY/MM/DD	HH:MM	Alarm text (see section 8.6)

\*Depends on the selected language (French by default).



### Reset Alarms – ALARMRST

Name	Status	Displayed text*	Description
RST_ALM	no/yes	Alarm Reset	Used to reset active alarms
ALM	-	Alarm State	Alarm state: Normal = No alarm Partial = There is an alarm, but the unit continues to operate Shutdown = Unit shuts down
alarm_1c	-	Current Alarm 1	Alarm code (see section 8.6)
alarm_2c	-	Current Alarm 2	Alarm code (see section 8.6)
alarm_3c	-	Current Alarm 3	Alarm code (see section 8.6)
alarm_4c	-	Current Alarm 4	Alarm code (see section 8.6)
alarm_5c	-	Current Alarm 5	Alarm code (see section 8.6)
alarm_1	-	Current Alarm 1 index	Alarm code (see section 8.6)
alarm_2	-	Current Alarm 2 index	Alarm code (see section 8.6)
alarm_3	-	Current Alarm 3 index	Alarm code (see section 8.6)
alarm_4	-	Current Alarm 4 index	Alarm code (see section 8.6)
alarm_5	-	Current Alarm 5 index	Alarm code (see section 8.6)

\*Depends on the selected language (French by default).

#### **IMPORTANT:**

- ***JBus vs. Modbus: Data exchange services offered by Modbus and JBus protocols are the same and therefore these terms can be used interchangeably.***

## 6 - CONTROL SYSTEM OPERATION

### 6.1 - Unit start/stop control

The unit state is determined based on a number of factors, including its operating type, active overrides, open contacts, master/slave configuration, or alarms triggered due to operating conditions.

The table given below summarises the unit control type [ctrl\_typ] and its running status with regard to the following parameters:

- **Operating type:** This operating type is selected using the Start/Stop button on the user interface.

LOFF	Local off
L-C	Local on
L-SC	Local schedule
REM	Remote
Net.	Network
MAST	Master unit

- **Start/stop force command [CHIL\_S\_S]:** Chiller start/stop force command can be used to control the chiller state in the Network mode.
  - Command set to stop: The unit is halted.
  - Command set to start: The unit runs in accordance with schedule 1.
- **Remote start/stop contact status [Onoff\_sw]:** Start/stop contact status can be used to control the chiller state in the Remote operating type.
- **Master control type [ms\_ctrl]:** When the unit is the master unit in a two-chiller master/slave arrangement, the master unit may be set to be controlled locally, remotely or via network.
- **Start/stop schedule [chil\_occ]:** Occupied or unoccupied status of the unit.
- **Network emergency stop command [EMSTOP]:** If activated, the unit shuts down regardless of the active operating type.
- **General alarm:** The unit shuts down due to failure.

Active operating type						Parameters status						Result	
LOFF	L-C	L-SC	Rem	Net	Mast	Start/stop force command	Remote start/stop contact	Master control type	Start/stop time schedule	Network emergency shutdown	General alarm	Control type	Unit state
-	-	-	-	-	-	-	-	-	-	enabled	-	-	off
-	-	-	-	-	-	-	-	-	-	-	yes	-	off
active	-	-	-	-	-	-	-	-	-	-	-	local	off
active	-	-	-	-	-	-	-	-	-	-	-	local	on
-	-	active	-	-	-	-	-	-	unoccupied	-	-	local	off
-	-	-	active	-	-	-	open	-	-	-	-	remote	off
-	-	-	active	-	-	-	-	-	unoccupied	-	-	remote	off
-	-	-	-	active	-	disable	-	-	-	-	-	network	off
-	-	-	-	active	-	-	-	-	unoccupied	-	-	network	off
-	-	-	-	-	active	-	-	local	unoccupied	-	-	local	off
-	-	-	-	-	active	-	open	remote	-	-	-	remote	off
-	-	-	-	-	active	-	-	remote	unoccupied	-	-	remote	off
-	-	-	-	-	active	disable	-	network	-	-	-	network	off
-	-	-	-	-	active	-	-	network	unoccupied	-	-	network	off
-	active	-	-	-	-	-	-	-	-	disable	no	local	on
-	-	active	-	-	-	-	-	-	occupied	disable	no	local	on
-	-	-	active	-	-	-	closed	-	occupied	disable	no	remote	on
-	-	-	-	-	-	-	-	-	occupied	disable	no	network	on
-	-	-	-	-	-	-	-	-	occupied	disable	no	local	on
-	-	-	-	-	-	-	-	-	occupied	disable	no	remote	on
-	-	-	-	-	-	-	-	-	occupied	disable	no	network	on

**IMPORTANT:** When the unit is stopping or there is a demand to stop the unit, compressors are stopped consecutively. In case of emergency stop, all compressors are stopped at the same time.

### 6.2 - Smart Grid Ready (option 157D)

The Smart Grid Ready ("SG Ready") label of the heat pump allows the energy supplier to access the heat pump and manage its four energy usage control states:

- Lockout state (LOCK)
- Normal operating state (NORMAL)
- Low current surplus state (BOOST)
- High current surplus state (FORCED)

**NOTE:** The Smart Grid Ready label is valid only in the DACH region (Germany, Austria, Switzerland).

To learn more about the Smart Grid Ready option and Smart Grid operating modes, please refer to Smart Grid Installation Instructions (see Appendix 1).

**IMPORTANT:** The Smart Grid Ready functionality (option 157D) is not provided as standard. Please contact the Manufacturer to purchase this option.

## 6 - CONTROL SYSTEM OPERATION

### 6.3 - Heating/Cooling/Standby

The control determines the heat/cool state of the unit. Chillers may operate in cooling mode and heat pumps may operate in cooling or heating mode.

When the unit is in **Heating mode**, the control may utilise the boiler to satisfy the heating demand. The boiler is used when mechanical heating is impossible or insufficient. Additionally, when the outside air temperature is very low, electric heaters can be used as a form of supplemental heating.

When **Cooling mode** is selected, the unit will operate in the Cooling mode and, as a result, the boiler or electric heating will not be activated.

If the unit is in **Standby mode**, it does not cool or heat and compressors are stopped. The pump is running with no mechanical cooling or heating unless configured otherwise. The pump may be stopped depending on pumps configuration (PUMPCONF – Pump Configuration).

#### Heating/Cooling changeover for heat pumps

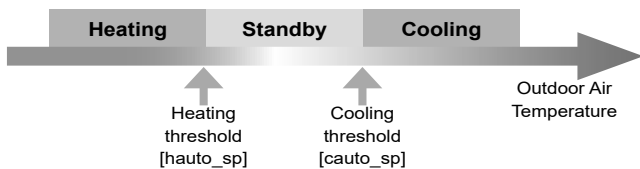

#### Operating mode control

The operating mode, i.e. cooling or heating, is determined based on the following parameters:

- Unit on/off status [status]: Unit running status.
- Control type [ctrl\_typ]: Local, Remote or Network.
- Local heat/cool selection [hc\_sel]: Heat/Cool selection when the unit is running in Local mode.
- Remote heat/cool selection [onsw\_cr]: Heat/Cool selection when the unit is running in Remote mode.
- Network heat/cool selection [HC\_SEL]: Heat/Cool selection when the unit is running in Network mode.
- Outdoor air temperature [OAT]: Heat/Cool setpoint selection when the automatic changeover has been enabled.

Control type	Heat / Cool (Local)	Heat / Cool (Remote)	Heat / Cool (Network)	Outdoor Air Temperature	Operating mode
local	cool	-	-	-	cooling
local	heat	-	-	-	heating
local	auto*	-	-	> cauto_sp + 1	cooling
local	auto*	-	-	< hauto_sp - 1	heating
local	auto*	-	-	hauto_sp + 1 < oat < cauto_sp - 1	standby
remote	-	on_cool	-	-	cooling
remote	-	on_heat	-	-	heating
remote	-	on_auto	-	> cauto_sp + 1	cooling
remote	-	on_auto	-	< hauto_sp - 1	heating
remote	-	on_auto	-	hauto_sp + 1 < oat < cauto_sp - 1	standby
network	-	-	cool	-	cooling
network	-	-	heat	-	heating
network	-	-	auto*	> cauto_sp + 1	cooling
network	-	-	auto*	< hauto_sp - 1	heating
network	-	-	auto*	hauto_sp + 1 < oat < cauto_sp - 1	standby

\* If auto changeover has been selected through user configuration; otherwise, by default set to "cooling".

#### Legend

cauto\_sp = cooling changeover setpoint (SETPOINT menu)  
 hauto\_sp = heating changeover setpoint (SETPOINT menu)  
 oat = outdoor air temperature

### 6.4 - Heating/Cooling selection

Heating/Cooling selection applies to heat pumps only. Heating/cooling selection can be controlled in various ways, depending on the active operating type. By default, the cooling mode is selected.

#### Heating/Cooling selection can be determined:

- Locally at the unit using the HC\_SEL item in the GENUNIT menu
- Remotely via the heating/cooling selection contact, if the unit is in the Remote mode
- Via a network command if the unit is in the Network mode

Heating/Cooling mode can be set manually by the user or automatically by the control. When heating/cooling is automatic, the outdoor air temperature determines the heat/cool/standby changeover (see the SETPOINT menu for cooling and heating mode changeover thresholds). The automatic changeover is optional and requires user configuration (GENUNIT – General Parameters).

#### To set cooling / heating / auto changeover

1. Navigate to the Main menu.
2. Select *General Parameters* (GENUNIT).
3. Set *Heat/Cool Select* [HC\_SEL].

Heat/Cool Select [HC_SEL]	
0	Cooling
1	Heating
2	Automatic changeover

#### To set cool / heat changeover setpoint

1. Navigate to the Main menu.
2. Select *Setpoint Configuration* (SETPOINT).
3. Set *Cool Changeover Setpt* [cauto\_sp] or *Heat Changeover Setpt* [hauto\_sp].

Cool Changeover Setpt [cauto_sp]	
3.9 to 50°C	23.9°C
39 to 122°F	75°F

Heat Changeover Setpt [hauto_sp]	
0 to 46.1°C	17.8°C
32 to 115°F	64°F

#### 6.4.1 - Boiler control

Boiler is activated when the outside air temperature is below the user-configured boiler outdoor temperature threshold which is by default set to -10°C (14°F).

#### To set boiler OAT threshold

1. Navigate to the Configuration menu.
2. Select *Heat/Cool Configuration* (HCCONFIG).
3. Set *Boiler OAT Threshold* [boil\_th].

Boiler OAT Threshold [boil_th]	
-15 to 15°C	-10°C
5 to 59°F	14°F

#### 6.4.2 - Electric heating control

Electric heating stages can be activated as additional heating when OAT is below the user-configured electric heating OAT threshold which is by default set to 5°C (41°F).

#### Electric heating is allowed when:

- Unit is running at 100% capacity.
- Electric pull-down time elapsed [ehs\_pull].
- OAT is below the OAT threshold [ehs\_th].

There are four electric heating stages, where the last electric heating stage is used for back-up when the unit is down due to a detected fault.



## 6 - CONTROL SYSTEM OPERATION

### To set electric heating OAT threshold

1. Navigate to the Configuration menu.
2. Select *Heat/Cool Configuration* (HCCONFIG).
3. Set *Elec Stage OAT Threshold* [ehs\_th].

Elec Stage OAT Threshold [ehs_th]	
-5 to 21°C	5°C
23 to 70°F	41°F

**IMPORTANT: Electric heating is not allowed when the demand limit is active on the unit.**

### 6.5 - Pumps control

The control system can manage one or two water exchanger pumps, determining each pump on/off state and its speed. Both pumps cannot run together. The pump is turned on when this option is configured and when the unit is running.

The pump is turned off when the unit is shut down due to an alarm, unless the fault is a frost protection error. The pump can be started in particular operating conditions when the water exchanger heater is active.

If the pump has failed and another pump is available, the unit is stopped and started again with the second pump. If there is no pump available, the unit shuts down.

Configuration options may differ depending on the number and type of pumps available (single speed pumps or variable speed pumps).

#### 6.5.1 - Variable speed pumps control

AQUACIAT LD chillers and AQUACIAT ILD heat pumps may be fitted with one or two variable speed pumps.

Variable speed pumps give the possibility of saving the pumping energy cost, providing precise water flow control and improving the overall performance of the system. The frequency inverter continuously regulates the flow rate to minimise the pump power consumption at full load and part load.

**Water flow management methods are as follows:**

- Fixed speed control (the control ensures a constant pump speed based on compressor capacity).
- Water flow control based on constant water delta pressure (the control continuously acts on the pump speed to ensure a constant delta pressure).
- Water flow control based on constant delta T on the water exchanger.
- For units with "External Variable Speed Pump" (customer pump), the control system will use a constant temperature differential (constant delta T) only for flow monitoring. The pump is controlled by a 0-10V signal (AO, CIOB/SIOB board).

**Fixed speed pumps can be either low or high pressure, whereas variable speed pumps are always high pressure pumps.**

#### 6.5.2 - Pumps configuration

The control can command internal fixed speed or variable speed pumps as well as customer pumps. Variable speed pumps may also be configured as fixed speed pumps (see also section 6.5.1).

Basic pump configuration can be performed via the Configuration menu (PUMPCONF – Pump Configuration). Only logged-in users can access the menu. The unit must be stopped.

**IMPORTANT: Pump speed configuration can be performed only by Service.**

#### To set pumps sequence

1. Navigate to the Configuration menu.
2. Select *Pump Configuration* (PUMPCONF).
3. Set *Pumps Sequence* [pump\_seq].

Pumps Sequence [pump_seq]	
0	No Pump
1	One Pump Only
2	Two Pumps Auto
3	Pump#1 Manual
4	Pump#2 Manual

#### 6.5.3 - Automatic pump selection

If two pumps are controlled and the reversing function has been selected (PUMPCONF – Pump Configuration), the control balances the pump run time to match the configured pump changeover delay.

If this delay has elapsed, the pump reversing function is activated.

#### To set pump automatic rotation delay

1. Navigate to the Configuration menu.
2. Select *Pump Configuration* (PUMPCONF).
3. Set *Pump Auto Rotation Delay* [pump\_del].

Pump Auto Rotation Delay [pump_del]	
24 to 3000h	48h

#### 6.5.4 - Customer pumps configuration

**Customer pumps may be configured as follows:**

Pump available	Pumps sequence (PUMPCONF)
No pump	0 (no pump)
One single speed pump	1 (one pump only)
Two single speed pumps	2 (two pumps auto) 3 (pump#1 manual) 4 (pump#2 manual)
One variable speed pump	1 (one pump only)

Units with customer pumps are fitted with the flow switch, allowing for the water flow control. For more information about actuators, see Water flow switch in section 3.8.

**IMPORTANT: The variable speed pump can be set only by Service.**

#### 6.5.5 - Pumps protection

The control provides the option to automatically start the pump each day at 14:00 for 2 seconds when the unit is off.

If the unit is fitted with two pumps, the first pump is started on even days and the second pump is started on odd days. Starting the pump periodically for a few seconds extends the lifetime of the pump bearings and the tightness of the pump seal.

Periodical pump quick start can be selected via the Configuration menu (Pump Sticking Protection, PUMPCONF – Pump Configuration).

#### To set periodical pump quick start

1. Navigate to the Configuration menu.
2. Select *Pump Configuration* (PUMPCONF).
3. Set *Pump Sticking Protection* [pump\_per].

Pump Sticking Protection [pump_per]	
No/Yes	Yes

#### 6.5.6 - ECO pump mode

When the unit is in Standby mode (heating or cooling demand is satisfied), by default the CONNECT TOUCH control stops the pump periodically in order to save energy.

#### To verify or modify the Eco Pump configuration

1. Navigate to the Main menu.
2. Select *Miscellaneous Status* (MSC\_STAT).
3. Verify *Eco Pump Mode Active* [m\_ecopmp].

Eco Pump Mode Active [m_ecopmp]	
No/Yes	Yes

## 6 - CONTROL SYSTEM OPERATION

### 6.6 - Hydronic kit option

The hydronic kit option allows for continuous monitoring of the water flow rate (PUMPSTAT – Pump Status).

The hydronic kit provides the option to measure the following parameters:

- Inlet and outlet water pressure.
- Water exchanger flow rate.

The water flow rate is based on the pressure difference between the inlet and outlet pressures and the pressure drop curves.

#### Hydronic kit option with variable speed pumps

For units with variable speed pumps, this option allows for the automatic adjustment of the pump speed necessary to maintain the correct water flow rate. Water flow control can be based on compressor usage, constant delta pressure or constant temperature difference.

For more information on Variable speed pumps control, see also section 6.5.1.

### 6.7 - Control point

The control point represents the water temperature that the unit must produce. The required capacity can be decreased depending on the unit load operating conditions.

#### Control point = Active setpoint + Reset

The control point is calculated based on the active setpoint and the reset calculation. The forced value can be used instead of any other setpoint calculation only when the unit is in the Network operating type.

#### 6.7.1 - Active setpoint

Two setpoints can be selected. Depending on the current operation type, the active setpoint can be selected manually via the Main menu (GENUNIT – General Parameters), with the volt-free user contacts, with network commands (Proprietary Protocol, BACnet or Modbus) or automatically with the setpoint time schedule (schedule 2).

The following tables summarise possible selections depending on the control operating type (Local, Remote or Network) and the following parameters:

- **Heating or Cooling operating mode [hc\_sel]:** Heat/Cool select (GENUNIT menu).
- **Setpoint selection [sp\_sel]:** Setpoint select permits selection of the active setpoint if the unit is in the Local operating type (GENUNIT menu).
- **Setpoint switch status [SETP\_SW]:** Remote Setpoint Switch (INPUTS menu).
- **Schedule 2 status [SP\_OCC]:** Schedule for setpoint selection.

#### LOCAL OPERATING TYPE

Parameter status				Active setpoint
Heating/ cooling	Setpoint selection	Setpoint switch	Schedule 2 status	
cooling	sp-1	*	*	cooling setpoint 1 (csp1)
cooling	sp-2	*	*	cooling setpoint 2 (csp2)
cooling	auto	*	occupied	cooling setpoint 1 (csp1)
cooling	auto	*	unoccupied	cooling setpoint 2 (csp2)
heating	sp-1	*	*	heating setpoint 1 (hsp1)
heating	sp-2	*	*	heating setpoint 2 (hsp2)
heating	auto	*	occupied	heating setpoint 1 (hsp1)
heating	auto	*	unoccupied	heating setpoint 2 (hsp2)

\*Any configuration.

#### REMOTE OPERATING TYPE

Parameter status				Active setpoint
Heating/ cooling	Setpoint selection	Setpoint switch	Schedule 2 status	
cooling	*	sp1 (open)	*	cooling setpoint 1 (csp1)
cooling	*	sp2 (closed)	*	cooling setpoint 2 (csp2)
heating	*	sp1 (open)	*	heating setpoint 1 (hsp1)
heating	*	sp2 (closed)	*	heating setpoint 2 (hsp2)

\*Any configuration.

#### NETWORK OPERATING TYPE

Parameter status				Active setpoint
Heating/ cooling	Setpoint selection	Setpoint switch	Schedule 2 status	
cooling	sp-1	*	*	cooling setpoint 1 (csp1)
cooling	sp-2	*	*	cooling setpoint 2 (csp2)
cooling	auto	*	occupied	cooling setpoint 1 (csp1)
cooling	auto	*	unoccupied	cooling setpoint 2 (csp2)
heating	sp-1	*	*	heating setpoint 1 (hsp1)
heating	sp-2	*	*	heating setpoint 2 (hsp2)
heating	auto	*	occupied	heating setpoint 1 (hsp1)
heating	auto	*	unoccupied	heating setpoint 2 (hsp2)

\*Any configuration.

#### 6.7.2 - Reset

Reset means the active setpoint is modified so that less machine capacity is required. In the cooling mode the setpoint is increased, whereas in the heating mode it is decreased.

The reset can be based on the following possibilities:

- OAT that gives the measure of the load trends for the building.
- Return water temperature ( $\Delta T$  provides the average building load).
- Dedicated 4-20 mA input.

The reset source and the reset parameters can be configured in the Main menu (RESETCFG – Reset Configuration). In response to a drop in the reset source (e.g. OAT), the cooling setpoint is normally reset upwards to optimise unit performance.

The amount of reset is determined by linear interpolation based on the following parameters:

- A reference at which reset is zero (no reset value).
- A reference at which reset is maximum (full reset value).
- The maximum reset value.

## 6 - CONTROL SYSTEM OPERATION

### Reset example in Cooling mode:

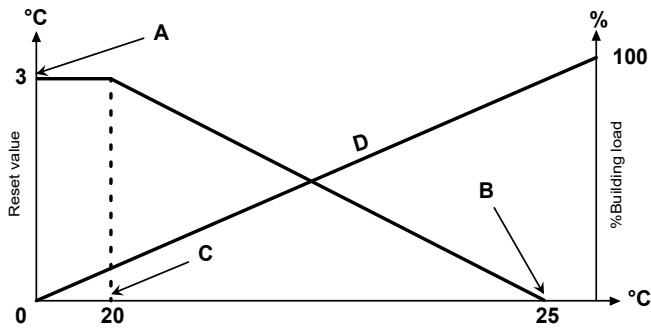

20	Reset based on OAT	25
0	Reset based on delta T	3
4	Reset based on analog input	20
no_reset	Selection	full_reset

#### Legend

- A: Maximum reset value
- B: Reference for zero reset
- C: Reference for maximum reset
- D: Building load

### 6.8 - Capacity limitation

CONNECT TOUCH allows for the constant control of the unit capacity by setting its maximum allowable capacity.

Capacity limitation is expressed in percentage, where a limit value of 100% means that the unit may run with its full capacity (no limitation is implemented).

#### The unit capacity can be limited:

- By means of user-controlled volt-free contacts. The unit capacity can never exceed the limit setpoint activated by this contact. The limit setpoints can be modified in the SETPOINT menu.
- By lag limit set by the master unit (master/slave assembly). If the unit is not in the Master/Slave assembly, the lag limit value is equal to 100%.
- By night mode limitation control. The demand limit value in the night mode is selectable if the value is below the selected limit.

#### To set limit setpoints

1. Navigate to the Main menu.
2. Select *Setpoint Configuration* (SETPOINT).
3. Set *Switch Limit Setpoint 1 / 2 / 3* [lim\_sp1 / 2 / 3].

Switch Limit Setpoint 1 / 2 / 3 [lim_sp1 / 2 / 3]	
0 to 100%	100%

#### To set the night mode limit

1. Navigate to the Configuration menu.
2. Select *General Configuration* (GENCONF).
3. Set *Night Capacity Limit* [nh\_limit].

Night Capacity Limit [nh_limit]	
0 to 100%	100%

Based on the limit source, the active demand limit value (DEM\_LIM) is set to the lowest possible value. DEM\_LIM can be forced by Network.

#### To verify active demand limit value

1. Navigate to the Main menu.
2. Select *General Parameters* (GENUNIT).
3. Verify *Active Demand Limit Val* [DEM\_LIM].

Active Demand Limit Val [DEM_LIM]	
0 to 100%	-

### 6.9 - Capacity control

The control adjusts the capacity to keep the water exchanger temperature at its setpoint. Compressors are started and stopped in a sequence designed to equalise the number of start-ups (value weighted by their operating time).

#### 6.9.1 - Circuit loading sequence

This function determines in which order the circuit capacity is changed. Compressor loading is managed by starting/stopping the compressors. Two types of sequencing, i.e. balanced and staged loading sequence, are available and can be configured by the user via the user interface (GENCONF – General Configuration).

**Balanced loading sequence:** The control maintains equal capacity between all circuits as the machine loads and unloads. Balanced loading sequence is the default sequence employed by the control.

**Staged loading sequence:** The control loads the lead circuit completely before the lag circuits are started. When the load is decreasing, the lag circuit is unloaded first. Staged loading sequence is active when one of the circuits is shut down due to its failure; the circuit is in capacity override mode; or the remaining circuits are shut down or fully charged.

#### To set the circuit loading sequence

1. Navigate to the Configuration menu.
2. Select *General Configuration* (GENCONF).
3. Set *Staged loading sequence* [seq\_typ].

Staged loading sequence [seq_typ]	
No/Yes	No

#### 6.9.2 - Capacity for multi-circuit unit

The circuit lead/lag function determines the lead and lag circuit of the unit. This function controls the start/stop sequence of two refrigeration circuits called circuit A and circuit B.

The circuit authorised to start first is the lead circuit. Lead circuit is used first for capacity increases and at the same time should be decreased first when decreasing capacity. The lead/lag circuits can be selected manually or automatically (*Cir Priority Sequence*, GENCONF – General Configuration).

■ **Manual lead/lag circuit determination:** Circuit A or circuit B selected as the lead circuit. The selected circuit takes priority over another circuit.

■ **Automatic lead/lag circuit determination:** The control system determines the lead circuit to equalise the operating time of each circuit (value weighted by the number of start-ups of each circuit). As a result, the circuit with the lowest number of operating hours always starts first.

#### To set circuit priority

1. Navigate to the Configuration menu.
2. Select *General Configuration* (GENCONF).
3. Set *Cir Priority Sequence* [lead\_cir].

Cir Priority Sequence [lead_cir]	
0	Auto
1	A Lead
2	B Lead

## 6 - CONTROL SYSTEM OPERATION

### 6.10 - Night mode

Night mode allows users to configure the unit to operate with specific parameters in a specific time period. During the night period, the unit capacity is limited. The number of operating fans is reduced (in cooling mode only).

The night period is defined by a start time and an end time that are the same for each day of the week. The Night mode settings or the maximum capacity value can be configured via the Configuration menu (GENCONF – General Configuration). Only logged-in users can modify the night mode settings.

#### To set the night mode

1. Navigate to the Configuration menu (logged-in users only).
2. Select *General Configuration* (GENCONF).
3. Set parameters corresponding to the night mode.

<b>Night Mode Start Hour [nh_start]</b>	
00:00 to 24:00	
<b>Night Mode End Hour [nh_end]</b>	
00:00 to 24:00	
<b>Night Capacity Limit [nh_limit]</b>	
0 to 100%	100%

### 6.11 - Coil pressure control

The coil pressure of each circuit is managed by two fans maximum. AQUACIAT (I)LD units are fitted with fixed speed fans, variable speed fans providing higher part load efficiency and reduced acoustic levels.

In cooling mode, the condensing pressure is controlled independently in each circuit based on the saturated condensing temperature. The control permanently adjusts its setpoint to guarantee optimal performance and ensure anti-short-cycle protection of the fans.

In heating mode, the evaporating pressure is controlled independently on each circuit based on the saturated suction temperature. The control permanently adjusts its setpoint to guarantee optimal performance, delay and limit frost accumulation on coils.

### 6.12 - Dry Cooler Free Cooling (DCFC)

AQUACIAT (I)LD chillers may be fitted with a dry cooler that enables power consumption reduction which amounts to energy and cost savings.

The installation of a dry cooler allows for "free cooling" – a method of using low outdoor air temperature as an aid to chilling water that is later used in the air-conditioning system. The system is the most effective when the outdoor air temperature is below 0°C (32°F).

This "dry cooler free cooling" mode is enabled when the outside air temperature ("OAT Free Cooling") is below the water loop temperature and the service-configured threshold parameter.

**NOTE: Dry cooler water loop temperature and free cooling OAT measured by the control are read-only values that can be verified in the DC Free Cooling Status menu (DCFC\_STA).**

The control distinguishes between two types of fan control for a dry cooler free cooling option, where the first one embraces the use of fan staging and the second one that includes the use of variable speed fan. Mixed configuration can also be used (fixed and variable-speed fan control at the same time).

Dry cooler free cooling is normally stopped when the outside air temperature ("OAT Free Cooling") is above the water loop temperature and the service-configured threshold parameter. However, if it turns out that the cooling power of the dry cooler is not enough in order to reach the cooling setpoint, then the mechanical cooling will be started (when FC capacity is at 100%, then mechanical cooling can be started).

### 6.13 - Refrigerant leakage detection (option 159)

The control permits refrigerant leak detection. One or two additional sensors that detect the refrigerant concentration in the air must be installed on the unit.

If one of this sensors detects an abnormal refrigerant level for more than one hour (timer set by service technicians), the alarm will be triggered, but the unit will continue to operate.

### 6.14 - Refrigerant leakage detection (option 159C)

For units with option 159C (factory-mounted leakage detection sensors), the controller will detect R32 refrigerant leakage.

Each circuit can be fitted with one R32 leakage detection sensor. In case the refrigerant leakage is detected, the alarm will be triggered and the compressor will be stopped (alarm 10227 for circuit A and alarm 10228 for circuit B). Please note that the affected circuit will be stopped only if the leakage alarm is enabled (USERCONF, leak\_alm = "yes").

The refrigerant leak detection sensor helps to reduce the environmental impact in case of gas leakage. The leakage detector is NOT a life safety device.

#### To set the leakage detection warning (alert/alarm)

1. Navigate to the Configuration menu.
2. Select *User Configuration* (USERCONF).
3. Set *Leakage alarm? (159C)* [leak\_alm].

<b>Leakage alarm? (159C) [leak_alm]</b>	
no	Circuit will NOT shut down when the refrigerant leakage is detected ("ALERT")
yes	Circuit will shut down when the refrigerant leakage is detected ("ALARM")

Regardless of leakage alarm configuration (USERCONF, leak\_alm), whenever the refrigerant leakage is detected, the fan(s) will start when the unit is in Local OFF or running.

**NOTE: Fans are running when the leakage detection alarm/alert is present and 30 seconds after the alarm/alert condition has been resolved.**

To ensure the equipment provides accurate measurements, it is also required to calibrate the leakage sensor(s) on a regular basis. This calibration can be performed only by service technicians.

### 6.15 - Desuperheater option

AQUACIAT (I)LD units may be fitted with a desuperheater that allows for better energy management. The desuperheater is used to extract the high pressure, high temperature heat from the refrigerant to "desuperheat" it to a lower pressure refrigerant. The vapour that goes into the desuperheater is not fully condensed; therefore, the refrigerant vapour must be channelled to a separate heat exchanger where the condensing process occurs.

Note that the desuperheater is enabled when the Desuperheater demand contact is closed.

#### To set minimal condensing setpoint

1. Navigate to the Main menu.
2. Select *Setpoint Configuration* (SETPOINT).
3. Set *Desuperheat Min SCT* [min\_sct].

<b>Desuperheat Min SCT [min_sct]</b>	
26.7 to 60°C	40°C
80 to 140°F	104°F

## 6 - CONTROL SYSTEM OPERATION

### 6.16 - Defrost control

When the outside air temperature is low and the ambient humidity is high, the probability of frost forming on the surface of the outdoor coil increases. The frost covering the outdoor coil may decrease the air flow across the coil and lead to lower performance of the unit. To remove the frost from the coil, the control initiates the defrost cycle when necessary.

During the defrost cycle, the circuit is forced into the cooling mode. To prevent the water loop from cooling down, optional electric heating may be started. The defrost cycle lasts until the end of defrost temperature is achieved.

### 6.17 - Master/slave assembly

The control system allows for master/slave control of two units linked by the network. The master unit can be controlled locally, remotely or by network commands, while the slave unit remains in Network mode.

All control commands to the master/slave assembly (start/stop, setpoint selection, heating/cooling operation, load shedding, etc.) are handled by the unit which is configured as the master. The commands are transmitted automatically to the slave unit.

If the master chiller is turned off, while the master/slave function is active, then the slave chiller will be stopped. Under certain circumstances, the slave unit may be started first to ensure that the run times of the two units are equalised.

In the event of a communication failure between the two units, each unit will return to an autonomous operating mode until the fault is cleared. If the master unit is stopped due to an alarm, the slave unit is authorised to start.

**IMPORTANT: Master/slave assembly can be configured only by Service.**

### 6.18 - Brine options (option 5, option 6)

AQUACIAT (I)LD units offer a selection of cooler fluid types, including standard water fluid as well as the optional brine fluid, i.e. medium brine (option 5) or low brine (option 6). The brine option is commonly used for low temperature applications.

Brine option	Aquaciat LD	Aquaciat ILD
Option 5	-	150-180
Option 6	150-600	200-300 520-600

**NOTE: Brine option requires a Software Activation Key (see section 6.22).**

### 6.19 - BACnet option (option 149)

The BACnet/IP communication protocol is used by BMS or the programmable controllers to communicate with the control.

**NOTE: BACnet option requires a Software Activation Key (see section 6.22).**

### 6.20 - Modbus (option 149B)

The Modbus communication protocol is used by the building management system or the programmable controllers to communicate with the CONNECT TOUCH control.

**NOTE: Modbus option does not require a Software Activation Key.**

### 6.21 - Heating optimized (option 119D)

The Heating Optimized option is used to enhance the heat pump performance in Heating mode and achieve higher Leaving Water Temperature.

Heat pumps with option 119D have counter flow heat exchangers that use flows in the opposite direction of each other ("counter flow"). The efficiency and the maximum amount of heat that can be obtained in counter flow is higher compared to fluids moving in the same direction under similar conditions.

**Counter flow:**

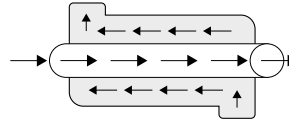

The "Heating optimized" option can be used only for fresh water applications (option 119D is not compatible with brine applications).

### 6.22 - Software Activation Key(s)

AQUACIAT (I)LD units with CONNECT TOUCH offer some additional options which require Software Activation Keys:

- **Cooler fluid type:**
  - Medium Brine (option 5),
  - Low Brine (option 6)
- **BACnet communication (option 149)**

These software-protected options can be factory-installed or installed on-site by the service technician or the customer.

**Each option requires an individual software activation key.** To obtain the Software Activation Key, please contact your local Service representative.

#### 6.22.1 - Software options

The list of available software activation keys can be verified via the Main menu.

**To verify available software options**

1. Go to the Main menu.
2. Select *Software Options* (OPT\_STA).  
*The menu can be accessed when logged in at user access level.*
  - If the status of the option is set to "yes", it means that the Software Activation Key for this option is installed.

OPT_STA - Software Options	
OPT6: Low Brine	No
OPT149: BACnet	No
OPT149B: Modbus	Yes
OPT5: Medium Brine	No

**IMPORTANT: In case the controller is replaced, the NEW Software Activation Key(s) based on the new MAC address must be installed again (see also section 6.22.2).**

## 6 - CONTROL SYSTEM OPERATION

### 6.22.2 - Replacement mode

If the controller is replaced with a new one, the system will be in the Replacement mode which may last up to 7 days beginning at the first start of the compressor.

- When replacing the controller, it is necessary to install NEW Software Activation Key(s).
- Please contact Service representatives immediately to request NEW Software Activation Key(s).

#### In the Replacement mode:

- Software option(s) will be unlocked for a limited period of time (7 days since the first start of the compressor). Only options that have been installed on the unit before will be active in the Replacement mode!
- The list of available software options can be verified via the Main menu (OPT\_STA – Software Options).
- Alarm 10122 will be triggered. If the NEW Software Activation Key is not installed during the Replacement mode, the alarm will be reset automatically and software option(s) will be blocked.

The Replacement mode ends when the Software Activation Key is installed or the period of 7 days elapsed (7 days since the first start of the compressor).

**IMPORTANT: Only software options that were installed on the unit before replacing the controller will be active during the Replacement mode!**

### 6.22.3 - Software key installation

#### To install the Software Activation Key via CONNECT TOUCH

1. Go to the Main menu.
2. Navigate to the Configuration menu (logged-in users only).
3. Select *Add Options* (ADD\_OPT).
  - When installing the Software Activation Key, please make sure that the unit is stopped.

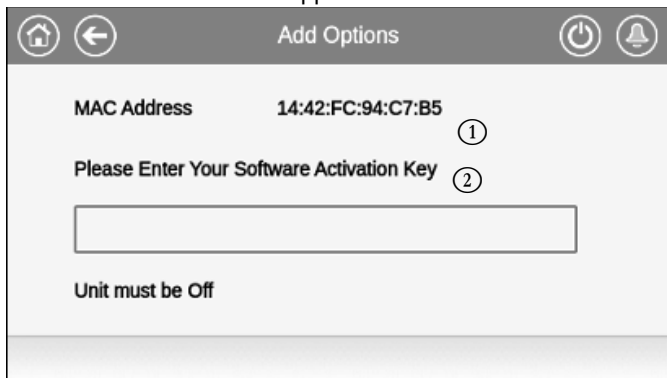

#### Legend:

1. Controller MAC address
2. Software Activation Key

4. Enter the **Software Activation Key**.
  - If the Software Key ends with two equality signs (==), then these signs can be omitted. The Key will be accepted.
  - The Software Activation Key is case-sensitive.
5. Once the Software Activation Key is provided in the Keyboard screen, press **OK**.
6. Once the Software Activation Key is validated, the following message will be displayed: **“Software Activation Key Added”**.
7. The parameter connected with the activated functionality is set automatically and the control system will also be rebooted automatically.
  - If the Software Activation Key is incorrect, the following message will be displayed: “Software Activation Key is Invalid”.
  - If the Software Activation Key has been added before, the following message will be displayed: “Key Already Set”.

### 6.23 - Schedule setting

The control incorporates two time schedules, where the first one (OCCPC01S) is used for controlling the unit start/stop, whereas the second one (OCCPC02S) is used for controlling the dual setpoint.

**The first timer program (schedule 1, OCCPC01S)** provides a means to automatically switch the unit from an occupied mode to an unoccupied mode. The unit is started during occupied periods.

**The second timer program (schedule 2, OCCPC02S)** provides a means to automatically switch the active setpoint from an occupied setpoint to an unoccupied setpoint. Cooling setpoint 1 is used during occupied periods and cooling setpoint 2 during unoccupied periods.

#### Occupancy periods

The control offers the user the possibility of setting eight occupancy periods where each occupancy period includes the following elements to be defined:

- **Day of the week:** Select the days when the period is occupied.
- **Occupancy time** (“occupied from” to “occupied to”): Set occupancy hours for the selected days.
- **Timed Override Extension:** Extend the schedule if necessary. This parameter can be used in the case of some unplanned events. Example: If the unit is normally scheduled to run between 8:00 to 18:00, but one day you want the air-conditioning system to operate longer, then set this timed override extension. If you set the parameter to “2”, then the occupancy will end at 20:00.

#### To set the unit start/stop schedule

1. Go to the Main menu.
2. Navigate to the Configuration menu (logged-in users only) and select *Schedule Menu* (SCHEDULE).
3. Go to *OCCPC01S*.
4. Select appropriate check boxes to set the unit occupancy on specific days.
5. Define the time of occupancy.
6. When the time schedule is set, the selected period will be presented in the form of the green band on the timeline.
7. Press the **Save** button to save your changes or the **Cancel** button to exit the screen without making modifications.

Example: Schedule 1 (Connect Touch 2.0)

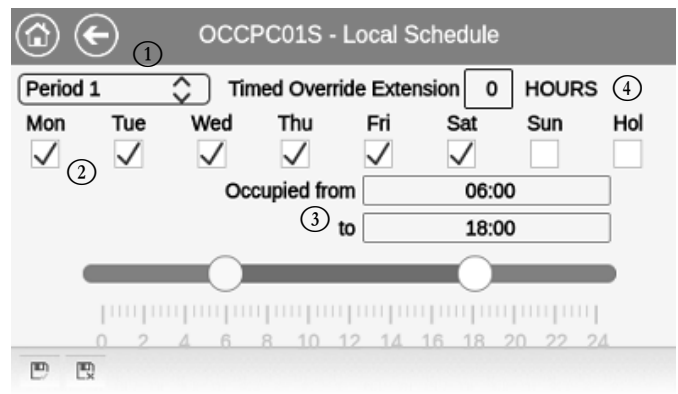

#### Legend

- ① Time period (Period 1 – Period 8)
- ② Selection of days for the time schedule (Monday - Sunday, Holiday)
- ③ Start/end of the schedule
- ④ Timed override extension (displayed only when "Period 1" is selected)

## 6 - CONTROL SYSTEM OPERATION

Each program is in unoccupied mode unless a schedule time period is active.

If two periods overlap and are both active on the same day, then the occupied mode takes priority over the unoccupied period.

### Example: Schedule setting (schedule 1)

Hour	MON	TUE	WED	THU	FRI	SAT	SUN	HOL
0:00	P1							
1:00	P1							
2:00	P1							
3:00								
4:00								
5:00								
6:00								
7:00	P2	P2	P3	P4	P4	P5		
8:00	P2	P2	P3	P4	P4	P5		
9:00	P2	P2	P3	P4	P4	P5		
10:00	P2	P2	P3	P4	P4	P5		
11:00	P2	P2	P3	P4	P4	P5		
12:00	P2	P2	P3	P4	P4			
13:00	P2	P2	P3	P4	P4			
14:00	P2	P2	P3	P4	P4			
15:00	P2	P2	P3	P4	P4			
16:00	P2	P2	P3	P4	P4			
17:00	P2	P2	P3					
18:00			P3					
19:00			P3					
20:00			P3					P6
21:00								
22:00								
23:00								

	Occupied
	Unoccupied

**MON:** Monday  
**TUE:** Tuesday  
**WED:** Wednesday  
**THU:** Thursday  
**FRI:** Friday  
**SAT:** Saturday  
**SUN:** Sunday  
**HOL:** Holiday

Period/Schedule	Starts at	Stops at	Active on (days)
P1: Period 1	0:00	3:00	Monday
P2: Period 2	7:00	18:00	Monday + Tuesday
P3: Period 3	7:00	21:00	Wednesday
P4: Period 4	7:00	17:00	Thursday + Friday
P5: Period 5	7:00	12:00	Saturday
P6: Period 6	20:00	21:00	Holidays
P7: Period 7	Not used in this example		
P8: Period 8	Not used in this example		

### 6.24 - Holidays

The control allows the user to define 16 holiday periods, where each period is defined by three parameters: the month, the start day and the duration of the holiday period.

During the holiday periods, the controller will be in occupied or unoccupied mode, depending on the periods validated as holidays. Each holiday period can be modified by the user via the Configuration menu (see also section 5.4).

### 6.25 - Trendings

This function enables to visualise the operations of the unit and monitor a set of selected parameters.

#### To display trends

- Go to the Main menu.
- Select *Trendings* (TRENDING).
- Select parameters to be displayed and press the **Save** button in the lower-left part of the screen.
  - A maximum of 4 trending points can be selected.
  - On Connect Touch 2.0 touch screen: Swipe up or swipe down to display other trending points.

Example: Trendings (Connect Touch 2.0)

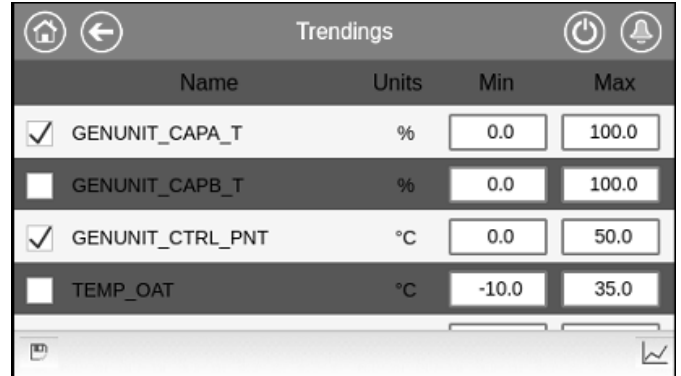

- Press the **Trending** button to display the graph showing trends for the set of selected parameters.

Example: Trendings plot (Connect Touch 2.0)

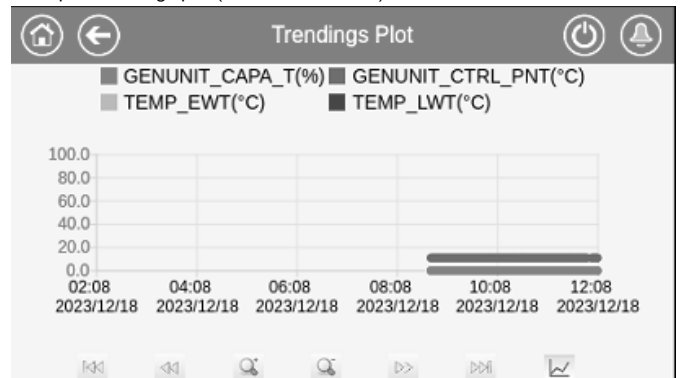

- Press to navigate across the timeline.
- Press the **Zoom in** button to magnify the view or the **Zoom out** button to expand the viewed area.
- Press the **Refresh** button ( on Connect Touch or on Connect Touch 2.0 touch screen) to reload data.

# 7 - WEB CONNECTION

## 7.1 - Web interface

The CONNECT TOUCH control provides the functionality to access and control unit parameters from a web interface.

**The Connect Touch display has been superseded by the Connect Touch 2.0 display** and the look of the web interface differs depending on the version of the touch screen installed on the machine (Connect Touch / Connect Touch 2.0).

**Pre-requisites:**

- Ethernet cable

**Minimum web browser configuration:**

- Internet Explorer (version 11 or later)
- Mozilla Firefox (version 60 or later)
- Google Chrome (version 65 or later)

### Connect Touch web interface

The legacy Connect Touch web interface looks like the touch screen interface. The navigation across menus is the same regardless of the connection method.

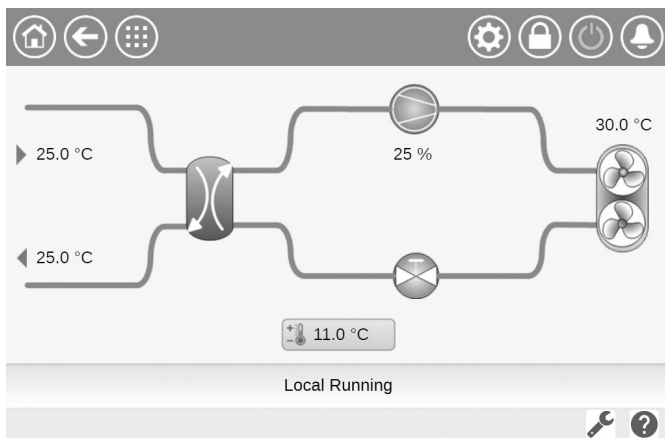

Three users can be connected simultaneously with no priority between them. The last modification is always taken into account.

### Connect Touch 2.0 web interface

The Connect Touch 2.0 touch screen comes with the new user-friendly web interface (see section 7.4). The new web interface provides a much more convenient way to monitor, set up or update the control system.

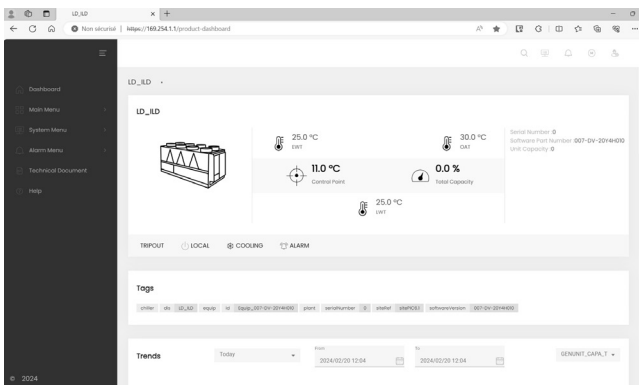

## 7.2 - Connect to the web interface

To connect to the controller via the web interface, it is necessary to know the IP address of the unit. This can be verified on the touch screen (System Menu > Network > IP Network Interface).

- Unit default address: 169.254.1.1 (J5, eth0).
- The unit IP address can be changed.

**To connect to the web interface**

1. Open the web browser.
2. Enter the IP address of the unit in the address bar of the web browser. Start with **https://** followed by the unit IP address.  
**Example: https://169.254.1.1**
3. Press Enter.
4. The web interface will be loaded.

For security reasons the unit cannot be started / stopped via the web interface. All other operations, including monitoring unit parameters or unit configuration, can be performed via the web browser interface.

**NOTE: Make sure that your network is protected from malicious attacks and any other security threats. Do not provide open access without proper network security safeguards. CIAT does not hold any responsibility or liability for damage caused by security breach.**

## 7.3 - Technical documentation

When using the CONNECT TOUCH control via a PC web browser, you may easily access all technical documents related to the product and its components.

**Connect Touch web UI:** Click the **Technical documentation** button  at the bottom of the page in order to see a list of documents related to the unit.

**Connect Touch 2.0 web UI:** Click "Technical Document"  in the navigation pane.

**Technical documentation includes the following documents:**

- Spare parts documentation: The list of spare parts included in the unit with reference, description and drafting.
- Misc: Documents such as electrical plans, dimension plans, unit certificates.
- PED: Pressure Equipment Directive.
- IOM: Installation operation and maintenance manual, controls installation/maintenance manual.

**Connect Touch web UI:** Click the **Help** button  to get access to BACnet user guide, Modbus user guide and Open Source Licenses used by Connect Touch.

**Connect Touch 2.0 web UI:** Click "Help"  in the navigation pane.

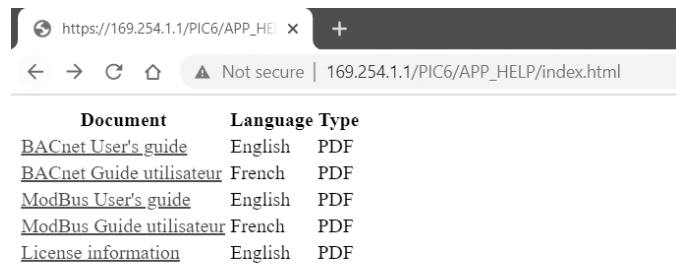

**IMPORTANT: Please save all data (documents, drawings, diagrams, etc.), for example, on your computer. If the display is replaced, all documents will be lost. Make sure that all documents are stored and may be accessed at any time.**



# 7 - WEB CONNECTION

## 7.4 - Connect Touch 2.0 web interface

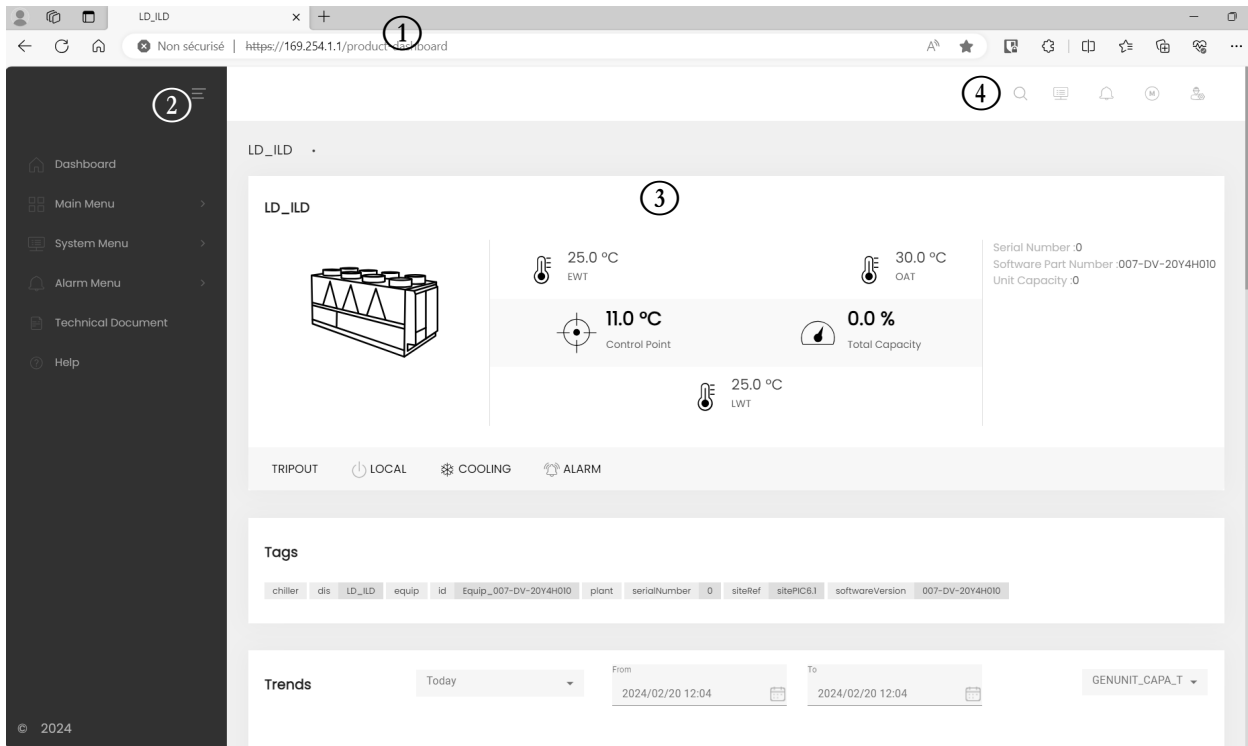

Aquaciat LD/ILD web interface (home screen)

### Web interface sections

- ① Address bar: Enter the IP address of the unit.
- ② The navigation pane on the left is used to switch between menus. Click/tap to expand/collapse the Navigation pane.
- ③ Main application window: Used to display the content of the selected menu.

Click/tap the menu icon in the navigation pane:

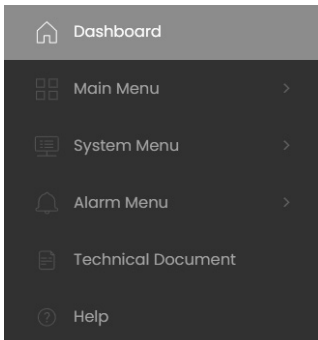

- ④ Quick access to Search, System menu, Alarm menu, Login and Start/Stop (read-only).

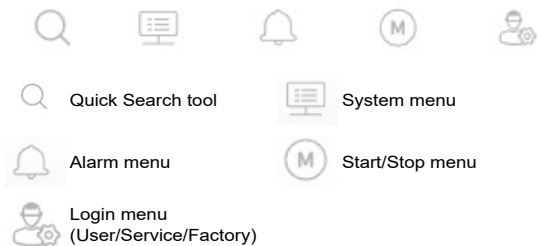

### Dashboard

The Dashboard is the first view displayed when connecting to the web interface. It gives a clear and comprehensive view of the current operations of the chiller.

This view is made up of several tiles that are snapshots of data presented in textual or graphical form:

#### ■ Aquaciat LD/ILD board

This main tile is used to display general information concerning the running status of the machine.

Example:

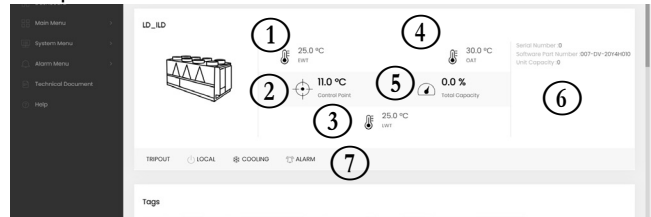

- ① Cooler EWT (Entering Water Temperature)
- ② Control point
- ③ Cooler LWT (Leaving Water Temperature))
- ④ Outside air temperature
- ⑤ Total capacity
- ⑥ Additional information:
  - Serial number
  - Software version
  - Unit capacity
- ⑦ Status bar

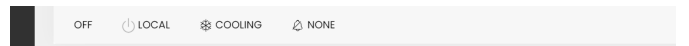

- Unit status: OFF / RUNNING / STOPPING / DELAY / TRIPOUT / READY / OVERRIDE / RUN TEST / TEST
- Heat/Cool selection: COOLING / HEATING
- Alarm status: ALARM / NO ALARM

**TIP: Hover over the image (or value) to see its description.**

## 8 - DIAGNOSTICS

### 8.1 - Control diagnostics

The control system has many fault tracing aid functions, protecting the unit against risks that could result in the failure of the unit. The local interface gives quick access to monitor all unit operating conditions. If an operating fault is detected, the alarm is triggered.

#### In the event of an alarm:

- The bell on the CONNECT TOUCH user interface starts ringing.



The **blinking bell** icon indicates that there is an alarm, but the unit is still running.



The **highlighted bell** icon indicates that the unit is shut down due to a detected fault.

- The corresponding alarm output(s) is/are activated.
- Error code is displayed.
- Message is sent over the network.

#### CONNECT TOUCH control distinguishes between two types of alarms:

- General alarms are used to indicate pumps failure, transducers faults, network connection problems, etc.
- Major alarms are used to indicate process failure.

**IMPORTANT: All information regarding alarms (current and past alarms) can be found in the Alarms menu (see also section 5.9).**

### 8.2 - Displaying current alarms

The Current alarms menu may display up to 10 current alarms.

#### To access the list of currently active alarms

1. Press the **Alarms menu** button in the upper-right part of the screen.
2. Select *Current Alarms* (ALAM\_CUR).
3. The list of active alarms will be displayed.

Current Alarms		
1:	2018/07/01 - 12:01	- Alarm
	Initial factory configuration required	
2:	2018/07/01 - 12:01	- Alarm
	Electrical Box Fault	
3:	2018/07/01 - 12:01	- Alarm
	Water Exchanger Freeze Protection	

1/1 ▲ ▼

### 8.3 - E-mail notifications

The control provides the option to define one or two recipients who receive e-mail notifications each time the new alarm occurs or all existing alarms have been reset.

#### To define e-mail recipients

1. Press the **Main menu** button and navigate to the Configuration menu.
2. Go to the Network menu.
3. Select *Email Configuration* (EMAILCFG).
4. Define user e-mail(s).

### 8.4 - Resetting alarms

The alarm can be reset either automatically by the control or manually through the touch panel display or the web interface.

- The Reset alarms menu displays up to 5 alarm codes which are currently active on the unit.
- Alarms can be reset without stopping the machine.
- Only logged-in users can reset the alarms on the unit.

#### To reset the alarm manually

1. Press the **Alarms menu** button in the upper-right part of the screen.
2. Select *Reset Alarms* (ALARMRST).
3. Set "Alarm Reset" to "Yes" and press the **Force** button.

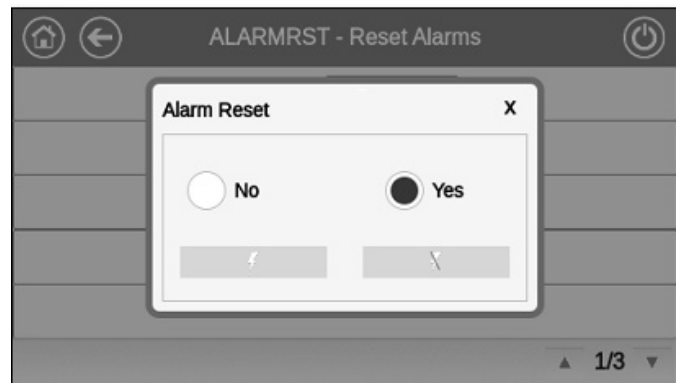

In the event of a power supply interrupt, the unit restarts automatically without the need for an external command. However, any faults active when the supply is interrupted are saved and may in certain cases prevent a circuit or a unit from restarting. Once the cause of the alarm has been identified and corrected, it will be displayed in the alarm history.

**IMPORTANT: Not all alarms can be reset by the user. Some alarms are reset automatically when operating conditions return to normal.**

### 8.5 - Alarm history

Information regarding resolved alarms is stored in the Alarm history menu which is divided into 50 recent alarms and 50 recent major alarms.

#### To access the alarm history

1. Press the **Alarms menu** button in the upper-right part of the screen.
2. Select *Alarm Historic* (ALARHIST) or *Major Alarm Historic* (ALARHIS2).
3. The history of alarms will be displayed.

Alarm Historic		
1:	2018/07/01 - 12:08	- Alarm
	Electrical Box Fault	
2:	2018/07/01 - 12:08	- Alarm
	Initial factory configuration required	
3:	2018/07/01 - 12:08	- Alarm
	Water Exchanger Freeze Protection	

1/1 ▲ ▼

## 8 - DIAGNOSTICS

### 8.6 - Alarm description

#### 8.6.1 - Alarms

JBus code	Code	Alarm description	Reset type	Action taken	Possible cause
<b>Thermistor failure</b>					
1	15001	Water Exchanger Entering Fluid Thermistor Failure	Automatic, if thermistor reading returns to normal	Unit shuts down	Defective thermistor or connection
2	15002	Water Exchanger Leaving Fluid Thermistor Failure	As above	Unit shuts down	As above
3	15003	Circuit A Defrost Thermistor Failure	As above	Cooling mode: Unit continues to operate Heating mode: Circuit A shuts down	As above
4	15004	Circuit B Defrost Thermistor Failure	As above	Cooling mode: Unit continues to operate Heating mode: Circuit B shuts down	As above
5	15010	OAT Thermistor Failure	As above	Unit shuts down	As above
6	15011	Master/Slave Common Fluid Thermistor Failure	As above	Master/slave operation is disabled and the unit returns to the stand-alone mode	As above
7	15053	Water Tank Output Thermistor Failure	As above	The alert shall be raised depending on "Tank Efficiency Alert" setting [tnk_alrt] in the Heat/Cool Configuration menu (HCCONFIG). The relay shall be energized depending on "Alarm Relay for Alerts?" setting [alert_r] in the User Configuration menu (USERCONF).	As above
8	15012	Circuit A Suction Gas Thermistor Failure	As above	Circuit A shuts down	As above
9	15013	Circuit B Suction Gas Thermistor Failure	As above	Circuit B shuts down	As above
10	15044	Coil Suction Gas Thermistor Sensor 1 Failure	As above	Cooling mode: None Heating mode: Unit shuts down	As above
11	15045	Coil Suction Gas Thermistor Sensor 2 Failure	As above	As above	As above
12	15015	Circuit A Discharge Gas Thermistor Failure	As above	Unit shuts down	As above
<b>Transducer failure</b>					
13	12001	Circuit A Discharge Pressure Transducer Failure	Automatic, if sensor voltage reading returns to normal	Circuit A shuts down	Defective transducer or connection
14	12002	Circuit B Discharge Pressure Transducer Failure	As above	Circuit B shuts down	As above
15	12004	Circuit A Suction Pressure Transducer Failure	Null voltage: Automatic (three alarms in the last 24 hours) or Manual Impossible value: Manual	Circuit A shuts down	As above
16	12005	Circuit B Suction Pressure Transducer Failure	As above	Circuit B shuts down	As above
<b>Communication failure</b>					
17	4901	Loss of communication with SIOB/CIOB Board Number A	Automatic, if communication is re-established	Unit shuts down	Bus installation fault, communication error
18	4902	Loss of communication with SIOB/CIOB Board Number B	As above	Unit shuts down	As above
19	4601	Loss of communication with AUX1 Board	As above	Unit shuts down	As above
20	4701	Loss of communication with VFD Fan Drive 1 Circuit A	As above	Units with one drive on the circuit: Circuit A shuts down Units with two drives on the circuit: Circuit A continues to run as long as one of two drives is communicating with the controller Note: Circuit A shuts down if communication with both drives is lost.	As above
21	4702	Loss of communication with VFD Fan Drive 2 Circuit A	As above	As above	As above
22	4703	Loss of communication with VFD Fan Drive 1 Circuit B	As above	Circuit B shuts down	As above

## 8 - DIAGNOSTICS

JBus code	Code	Alarm description	Reset type	Action taken	Possible cause
23	4705	Loss of communication with VFD Pump Drive Number 1	As above	Unit is restarted with another pump running. If no pumps are available, the unit shuts down	As above
24	5001	Loss of communication with Leak detector A	As above	Regardless of leakage alarm configuration (USERCONF, leak_alm = "yes" or "no"), the fan(s) will start when the unit is in Local OFF or running. Note: Fans are running when this alert is present and 30 seconds after the alert condition has been resolved.	As above
25	5002	Loss of communication with Leak detector B	As above	As above	As above
<b>Process failure</b>					
26	10001	Water Exchanger Freeze Protection	Automatic (the first alarm in the last 24 hours) or Manual	Unit shuts down, but the pump continues to run	No water flow, defective thermistor
27	10005	Circuit A Low Saturated Suction Temperature	As above	Circuit A shuts down	Pressure transducer defective, EXV blocked or lack of refrigerant
28	10006	Circuit B Low Saturated Suction Temperature	As above	Circuit B shuts down	As above
29	10008	Circuit A High Superheat	Manual	Circuit A shuts down	Pressure transducer defective, temperature sensor defective, EXV blocked or lack of refrigerant
30	10009	Circuit B High Superheat	Manual	Circuit B shuts down	As above
31	10011	Circuit A Low Superheat	Manual	Circuit A shuts down	As above
32	10012	Circuit B Low Superheat	Manual	Circuit B shuts down	As above
33	10014	Cooler Interlock Failure	Automatic (the unit is OFF) or Manual	Unit shuts down	Customer interlock input set on
34	10016	Compressor A1 Not Started or Pressure Increase Not Established	Manual	Compressor A1 shuts down	Compressor breaker or fuse fault, compressor switch open
35	10017	Compressor A2 Not Started or Pressure Increase Not Established	Manual	Compressor A2 shuts down	As above
36	10018	Compressor A3 Not Started or Pressure Increase Not Established	Manual	Compressor A3 shuts down	As above
37	10020	Compressor B1 Not Started or Pressure Increase Not Established	Manual	Compressor B1 shuts down	As above
38	10021	Compressor B2 Not Started or Pressure Increase Not Established	Manual	Compressor B2 shuts down	As above
39	10029	Loss of communication with System Manager	Automatic, if communication with System Manager is restored	Unit returns to the standalone mode	Communication error
40	10030	Master/Slave Communication Failure	Automatic, if communication is re-established	Master/slave operation is disabled and the unit returns to the stand-alone mode	As above
<b>Service and factory</b>					
41	90nn	Master Chiller Configuration Error	Automatic, if master/slave configuration returns to normal or the unit returns to the standalone mode	Master/slave operation is disabled and the unit returns to the stand-alone mode	Configuration failure
42	8000	Initial factory configuration required	Automatic, if configuration is provided	Unit cannot be started	No factory configuration
43	700n	Illegal configuration	Automatic, if configuration is corrected	Unit cannot be started	7001: Undefined unit size 7002: Undefined water pump 7003: Illegal EHS configuration 7004: High Fan Speed allowed with EC Fan configured 7005: Illegal configuration of the "Heating Optimized" option (option 119D)
<b>Process failure</b>					
44	10031	Unit is in Network Emergency Stop	Automatic, if emergency stop is deactivated	Unit shuts down	Network emergency stop command

## 8 - DIAGNOSTICS

JBus code	Code	Alarm description	Reset type	Action taken	Possible cause
45	10032	Cooler Pump 1 Fault	Manual	Unit is restarted with another pump running. If no pumps are available, the unit shuts down	Evaporator flow switch or evaporator pump fault
46	10033	Cooler Pump 2 Fault	Manual	As above	As above
47	10037	Circuit A Repeated High Discharge Gas Overrides	Automatic (no discharge gas override within 30 min) or Manual (the counter forced to 0)	None	Repetitive capacity decreases
48	10038	Circuit B Repeated High Discharge Gas Overrides	As above	None	As above
49	10040	Circuit A Repeated Low Suction Temp Overrides	Manual (the counter forced to 0)	Circuit A shuts down	Repetitive capacity decreases
50	10041	Circuit B Repeated Low Suction Temp Overrides	As above	Circuit B shuts down	As above
51	10043	Low Entering Water Temperature In Heating	Automatic (EWT returns to normal or Heating mode is disabled)	None	Low entering fluid temperature in Heating mode
52	10097	Water Exchanger Temperature Sensors Swapped	Manual	Unit shuts down	Input and output temperature reversed
<b>Service maintenance warning</b>					
53	13nnn	Service maintenance alert 001: Circuit A Loss of Charge 002: Circuit B Loss of Charge 003: Water Loop Size Warning 004: Maintenance Servicing Required	Manual (13001-13003) Automatic (13004), if the new date is set by service technicians	Depending on the severity of the alarm, the unit may continue to operate or the unit shuts down	Servicing action required. Contact Service representatives
<b>VFD drive failure</b>					
54	170nn	Circuit A VFD Fan Drive 1 Failure	Automatic	None (alert)	Speed controller fault (see also section 8.6.4)
55	180nn	Circuit A VFD Fan Drive 2 Failure	Automatic	None (alert)	As above
56	190nn	Circuit B VFD Fan Drive 1 Failure	Automatic	None (alert)	As above
57	21nnn	VFD Pump 1 Drive Failure	Automatic	Unit is restarted with another pump running. If no pumps are available, the unit shuts down	As above
<b>SIOB/CIOB board failure</b>					
58	57001	Circuit A SIOB/CIOB Low Voltage Failure	Automatic, if the alarm occurred not more than 6 times in the last 24 hours (otherwise manual)	Unit shuts down	Unstable electrical supply or electrical issue
59	57002	Circuit B SIOB/CIOB Low Voltage Failure	As above	Unit shuts down	As above
<b>Transducer failure</b>					
60	12024	Water Exchanger Entering Fluid Transducer Failure	Automatic, if sensor voltage reading returns to normal	Unit shuts down, water pressure calibration erased	Defective transducer or connection
61	12025	Water Exchanger Leaving Fluid Transducer Failure	As above	As above	As above
<b>Process failure</b>					
62	11202	Cooler Water Loop : Delta Pressure Error	Automatic, if water pressure delta returns to normal	Unit shuts down	Too low or high water pressure reading
63	11203	Cooler Water Loop : Pressure Too Low	Automatic, if water pressure reading returns to normal and the alarm occurred not more than 6 times in the last 24 hours (otherwise manual)	Unit shuts down	Low pump inlet pressure is below 60 kPa
64	11204	Cooler Water Loop : Pump Not Started	Automatic	Pump is stopped	Too low or high water pressure reading
65	11205	Cooler Water Loop : Pressure Error During Runtest	Manual	Unit shuts down	Too low or high water pressure reading
66	11206	Cooler Water Loop : Pump Overload	Automatic	None (alert): The relay shall be energized depending on "Alarm Relay for Alerts?" setting [alert_r] in the User Configuration menu (USERCONF).	Water loop pressure drop too low
67	11207	Cooler Water Loop : Flow Too Low	Automatic, when water flow reading returns to normal	None (alert)	Water loop pressure drop too high
68	11208	Cooler Water Loop : Pressure Sensors Crossed	Manual	Unit shuts down	Pressure sensors crossed
69	11209	Cooler Water Loop : Low Pressure Warning	Automatic, if water pressure reading returns to normal	None	Evaporator water pressure is below 100 kPa

## 8 - DIAGNOSTICS

JBus code	Code	Alarm description	Reset type	Action taken	Possible cause
70	10063	Circuit A High Pressure Switch Failure	Manual	Circuit A shuts down	Switch fault
71	10064	Circuit A2/B High Pressure Switch Failure	Manual	Circuit A2/B shuts down	As above
72	10099	Possible Refrigerant Leakage Failure	Automatic	None	Refrigerant leak or leak detector defective
73	10101	Free Cooling Process Failure	Automatic	None	Fan fault, dirty beam
<b>Thermistor failure</b>					
74	15046	Free Cooling Water Loop Thermistor Failure	Automatic, if thermistor reading returns to normal	Free cooling is disabled	Defective thermistor
75	15047	Free Cooling Leaving Water Thermistor Failure	As above	As above	As above
76	15048	Free Cooling OAT Sensor Failure	As above	As above	As above
<b>Communication failure</b>					
77	4602	Loss of communication with Free Cooling Board 1	Automatic, if communication is re-established	None	Bus installation fault, communication error
<b>Service maintenance warning</b>					
78	13005	Fgas check needed, call your maintenance company	Automatic, if the new date is set by service technicians	None	Service action required. Contact Service
79	10109	Tank EHS Low Efficiency Alert	Automatic	EHS shall be checked by a technician	The Heat produced by water tank's EHS is too low
<b>Replacement mode: Software Activation Key(s) missing</b>					
80	10122	Replacement mode: Please contact Service representative to activate options	Automatic, if Software Activation Key is installed Automatic, if Software Activation Key is not provided within 7 days since the first compressor start (the alarm will be reset and software - protected options will be blocked)	Replacement Mode: Please contact Service representative to obtain activation key(s) to retrieve (or activate) software options	CONNECT TOUCH controller was replaced, but Software Activation Key is not installed (see section 6.22.2)
<b>Process failure</b>					
81	10210	Compressor Running Outside MAP - cir A	Automatic (three alarm occurrences in the last 24 hours), otherwise manual Automatic reset is active when the capacity of the circuit is 0%	Unit shuts down	The compressor is running outside its limits
82	10211	Compressor Running Outside MAP - cir B	As above	Unit shuts down	As above
<b>Configuration failure</b>					
84	8001	Illegal Brand Identifier	Automatic, if configuration is corrected	Unit not allowed to start	Incorrect unit configuration
<b>Software failure</b>					
85	56001	Lenscan module Failure	Manual	Unit shuts down	Software problem. Contact service technicians.
<b>Leakage detector failure</b>					
83	13006	Leakage detector check needed, call your maintenance company	Automatic, when sensor calibration is completed	None (alert only)	Service action required. Contact service technicians.
86	60nnn	Leakage detector A Warning	Automatic, when conditions return to normal	Regardless of leakage alarm configuration (USERCONF, leak_alm = "yes" or "no"), the fan(s) will start when the unit is in Local OFF or running (see also section 6.14). Note: Fans are running when this alert is present and 30 seconds after the alert condition has been resolved.	Leakage detector warning (see section 8.6.2)
87	62nnn	Leakage detector B Warning	Automatic, when conditions return to normal	As above	As above
88	61nnn	Leakage detector A Error	Automatic, when conditions return to normal	As above	Leakage detector error (see section 8.6.3)
89	63nnn	Leakage detector B Error	Automatic, when conditions return to normal	As above	As above

## 8 - DIAGNOSTICS

JBus code	Code	Alarm description	Reset type	Action taken	Possible cause
90	10227	Leak detected cirA	Automatic, when conditions return to normal	<p>For units with leakage alarm enabled (USERCONF, leak_alm = "yes"): Circuit A shuts down when the refrigerant leakage is detected ("alarm")</p> <p>For units with leakage alarm disabled (USERCONF, leak_alm = "no"): No action ("alert" only)</p> <p>Note: Regardless of leakage alarm configuration (USERCONF, leak_alm = "yes" or "no"), fans are running when this alarm/alert is present and 30 seconds after the alarm/alert condition has been resolved.</p>	Refrigerant leakage detected (LFL is above the preconfigured gas threshold)
91	10228	Leak detected cirB	Automatic, when conditions return to normal	<p>For units with leakage alarm enabled (USERCONF, leak_alm = "yes"): Circuit B shuts down when the refrigerant leakage is detected ("alarm")</p> <p>For units with leakage alarm disabled (USERCONF, leak_alm = "no"): No action ("alert" only)</p> <p>Note: Regardless of leakage alarm configuration (USERCONF, leak_alm = "yes" or "no"), fans are running when this alarm/alert is present and 30 seconds after the alarm/alert condition has been resolved.</p>	Refrigerant leakage detected (LFL is above the preconfigured gas threshold)

### 8.6.2 - Leakage detection warnings

Leakage detection warnings are displayed as follows:

- 60nnn = Leakage detector A Warning (circuit A)
- 62nnn = Leakage detector B Warning (circuit B)

Code (nnn)	Warning	Description
000	NO_WARNING	No warning
001	WARMUP_WARNING	Warm-up warning (60 seconds): Fans are running during the warm-up period in order to ensure proper ventilation, for example, in case of refrigerant leakage.
002	INVALID_ACTIVE_WARNING	Active signal not included within the functional limits expected
004	INVALID_REFERENCE_WARNING	Reference not included within the functional limits expected
008	INVALID_TEMPERATURE_WARNING	Temperature not included within the functional limits expected
016	INVALID_READINGS_WARNING	Active and reference signals changed too fast: This condition can happen in case of fast gas flow rate transient, fast temperature changes and presence of radio frequency, interferences (in case this flag is active then gas concentration is frozen)
032	INVALID_ACTIVERMS_WARNING	WRONG VALUES on the active channel: Active signal is too low
064	INVALID_REFERENCERMS_WARNING	WRONG VALUES on the reference channel: Reference signal is too low
128	HW_TEST_WARNING	Hardware test in progress (5 seconds). It is performed once per day. This warning is for information only.

It is possible to have more than one warning active at the same time. When two or more warnings are active simultaneously, the actual warning code is the sum of all active warning codes.

Example:

Active warnings: INVALID\_ACTIVE\_WARNING (002)  
INVALID\_REFERENCE\_WARNING (004)

Warning code: 002 + 004 = 006

**IMPORTANT: In case the leakage detector warning appears, it is highly recommended to turn the machine off and on again. The power cycle may resolve the issue. If the problem persists, please contact your local service agency.**

## 8 - DIAGNOSTICS

### 8.6.3 - Leakage detection errors

Leakage detection errors are displayed as follows:

- 61nnn = Leakage detector A Error (circuit A)
- 63nnn = Leakage detector B Error (circuit B)

Code (nnn)	Error	Code (nnn)	Error
000	NO_ERROR	016	VIN_ERROR
002	E2PROM_CKSM_ERROR	018	FLASH_WRITE_ERROR
003	FLASH_CKSM_ERROR	019	FLASH_ERASE_ERROR
004	RAM_ERROR	020	E2PROM_WRITE_ERROR
005	VDD_ERROR	022	RFI_ERROR
006	I2C_ERROR	023	VBG_ERROR
008	SPI_ERROR	024	LAMP_ERROR
009	VREF_ERROR	025	AMP_ERROR
010	DAC_ERROR	032	UART_ERROR
014	ADC_ERROR	033	CONFIG_ERROR
015	SW_ERROR	034	V_LAMP_ERROR

**IMPORTANT: In case the leakage detector error appears, it is highly recommended to turn the machine off and on again. The power cycle may resolve the issue. If the problem persists, please contact your local service agency.**

### 8.6.4 - Fans and pumps drive alarms

Fan drive alarms are displayed based on the following formula:

- 17-YYY to 19-YYY (17=A1, 18=A2, and 19=B) for alarms (YYY stands for the alarm code).

Pump drive alarms are displayed based on the following formula:

- Pump drive alarms are displayed as 21-YYY for pump 1 (YYY stands for the alarm code).

Code	Description	Code	Action to be taken
0	No error	NErr	Contact Service if more information is needed
1	Overcurrent during acceleration	OC1	As above
2	Overcurrent during deceleration	OC2	As above
3	Overcurrent during constant speed operation	OC3	As above
4	Motor short circuit	OCL	As above
5	Ground short circuit	OCA	As above
8	Input phase failure	EPHI	As above
9	Output phase failure	EPHO	As above
10	Overvoltage during acceleration	OP1	As above
11	Overvoltage during deceleration	OP2	As above
12	Overvoltage during constant speed operation	OP3	As above
13	Drive overload	OL1	As above
14	Motor overload	OL2	As above
16	Drive overheating	OH	As above
17	Emergency stop	E	As above
18	EEPROM fault 1 (data writing error)	EEP1	As above
19	EEPROM fault 2	EEP2	As above
20	EEPROM fault 3 (data reading error)	EEP3	As above
-	Speed reference alarm	Err1	As above
21	RAM fault	Err2	As above
22	ROM fault	Err3	As above
23	CPU fault	Err4	As above
24	Serial communication error (RJ45)	Err5	As above
26	Current detector fault	Err7	As above
27	Serial communication interruption (network error)	Err8	As above
28	Graphic keypad communication error	Err9	As above
29	Small-current trip (underload error)	UC	As above
30	Trip due to under voltage in main circuit (undervoltage error)	UP1	As above
32	Overtorque trip	Ot	As above
34	Ground fault trip (hardware detection)	EF2	As above
37	Short circuit or ground fault during acceleration	OC1P	As above
38	Short circuit or ground fault during deceleration	OC2P	As above



## 8 - DIAGNOSTICS

---

Code	Description	Code	Action to be taken
39	Short circuit or ground fault during constant speed operation	OC3P	As above
41	Drive fault: Control board incompatibility error	EtYP	As above
46	External thermal input (PTC overheating)	OH2	As above
47	Synchronous motor jammed error (permanent magnet motor step-out)	SOUt	As above
50	VIA analogue input signal fault	E-18	As above
51	CPU fault (CPU communication error)	E-19	As above
52	Excessive torque boost	E-20	As above
53	CPU fault	E-21	As above
72	Closed damper 1 fault	Fd1	As above
73	Opened damper 2 fault	Fd2	As above
79	Multi-motors overload error	OL2M	As above
84	Auto-tuning error	Etn1	As above
-	Download transfer fault	CFI2	As above
304	Drive configuration failure	-	As above

## 9 - MAINTENANCE

---

In order to ensure the optimal operation of the equipment as well as the optimisation of all the available functionalities, it is recommended to activate a Maintenance Contract with your local Service Agency.

The contract will ensure your equipment is regularly inspected by specialists, so that any malfunction is detected and corrected quickly, and no serious damage can occur to your equipment.

The Maintenance contracts represents not only the best way to ensure the maximum operating life of your equipment, but also, through the expertise of qualified personnel, the optimal tool to manage your system in a cost-effective manner.

# 10 - APPENDIX 1: SMART GRID READY INSTALLATION INSTRUCTIONS

## 10.1 - Introduction

The increase in renewable electricity generation is leading more and more to load fluctuations. These fluctuations can be intelligently compensated by smart grid systems which combined with heat pumps allow an efficient use of energy. Electrical energy can be converted into thermal energy (heat) and the heat can be stored with the use of a water tank.

The Smart Grid Ready ("SG Ready") label of the heat pump allows the energy supplier to access the heat pump and manage its four energy usage control states. These states are activated through two inputs (SGR0\_BST and SGR1\_LCK).



The Smart Grid Ready label is valid only in the DACH region (Germany, Austria, Switzerland).

This document contains information about four "energy usage" control states supported by the heat pump and gives instructions on how the system should be configured by an installer.

It is strongly recommended to read the whole document prior to starting any installation or maintenance procedures. Please note that screenshots provided in this manual are solely for the purpose of illustration and they may differ from the actual look.

**The Smart Grid Ready functionality (option 157D) is not provided as standard. It can be purchased during unit selection. If the Smart Grid Ready option has not been previously purchased, contact the Manufacturer**

**For ILD 150R-600R, the SG Ready option requires factory configuration**

## 10.2 - Configuration of Smart Grid Ready option

The ability to configure the Smart Grid Ready function is only possible from the factory level. Please contact the Manufacturer to enable the Smart Grid Ready option on the device.

### Smart Grid Ready inputs

Two digital inputs (SGR0\_BST and SGR1\_LCK) are used to allow the energy supplier to control the heat pump and enhance load management.

After wiring these two digital inputs (SGR0\_BST and SGR1\_LCK) to the energy supplier module and enabling the "SG Ready" option, the Smart Grid Ready option offers four energy control modes (1 = LOCK, 2 = NORMAL, 3 = BOOST, 4 = FORCED).

The status of Smart Grid inputs can be verified in the Inputs menu on the local touch screen.

### To verify the status of Smart Grid inputs

1. Tap to open the Main Menu.

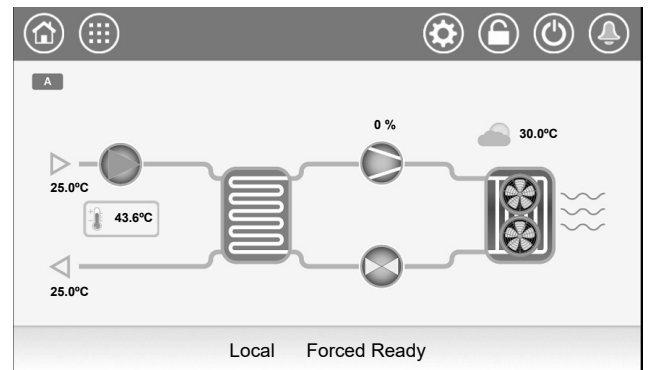

2. Select "Inputs"

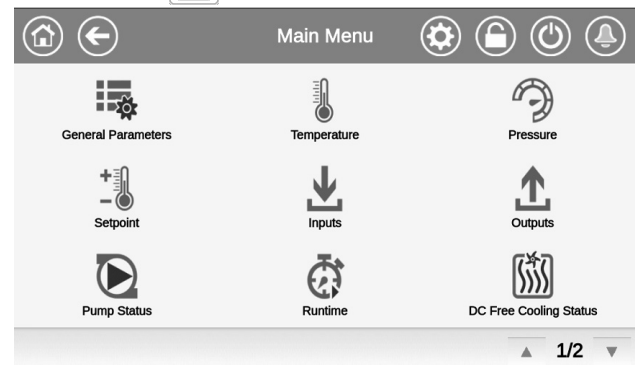

3. The Inputs menu will be displayed.

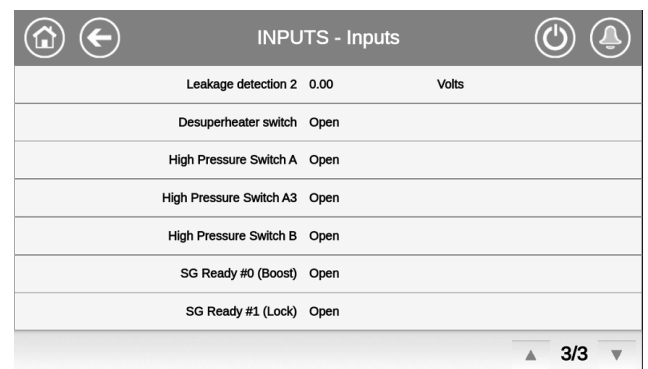

4. Go to the third page of the "Inputs" menu to find the status of Smart Grid Ready Inputs:
  - SG Ready #0 (Boost),
  - SG Ready #1 (Lock).

# 10 - APPENDIX 1: SMART GRID READY INSTALLATION INSTRUCTIONS

## 10.3 - Smart Grid Ready operating modes

For heat pumps with Smart Grid enabled, there are four control states ("energy control modes") available.

The active mode depends on SGR1\_LCK and SGR0\_BST signals:

State	Name	SGR1_LCK	SGR0_BST
1	LOCK	1	0
2	NORMAL	0	0
3	BOOST	0	1
4	FORCED	1	1

### Smart Grid operating modes:

- **Lockout state (1 = LOCK):** In this mode, the heat pump occupancy is turned off in order to stop the heat pump. If configured, the boiler output is turned on. The buffer tank will be used to provide heating demand. See also section 10.3.2.

  - The energy supplier can block the operations of the heat pump (activate the LOCK mode) for a maximum of 6 hours a day. One lockout may last 2 hours maximum and there must be at least a two-hour interval between two lockouts. For example, if the lockout starts at 10:00 and ends at 12:00, then the next lockout cannot be activated until 14:00.
- **Normal operating state (2 = NORMAL):** In this mode, the heat pump runs in energy-efficient normal mode with proportional heat storage.
- **Low current surplus state (3 = BOOST):** In this mode, the energy supplier allows the heat pump to run at its maximum capacity. The heat pump is requested to use the surplus energy to reach the maximum possible temperatures for heating and warm water. A user-defined offset is applied to the desired temperature setpoint (see section 10.3.3).

  - This is not a definite start-up command, but a switch-on recommendation based on the boost in energy supply.
- **High current surplus state (4 = FORCED):** In this mode, the heat pump is forced run at its maximum capacity.

In heating mode, the heating setpoint is set to its upper limit. In cooling mode, the heating setpoint is set to its lower limit.

The heat pump occupancy is turned on independently of any schedule program. This can be for the buffer tank, room heating or domestic hot water production.

  - The heat pump will run in this mode for an undetermined period of time (until the FORCED mode is deactivated).

## 10.3.1 - Smart Grid status

The Smart Grid Status can be found in the General Parameters menu (GENUNIT) or at the bottom of the Connect Touch touch screen.

### To check the Smart Grid mode or change Heat/Cool mode

1. Tap  to open the Main Menu.
  - The Smart Grid mode is displayed at the bottom bar on the Connect Touch touch screen ("Forced Ready").

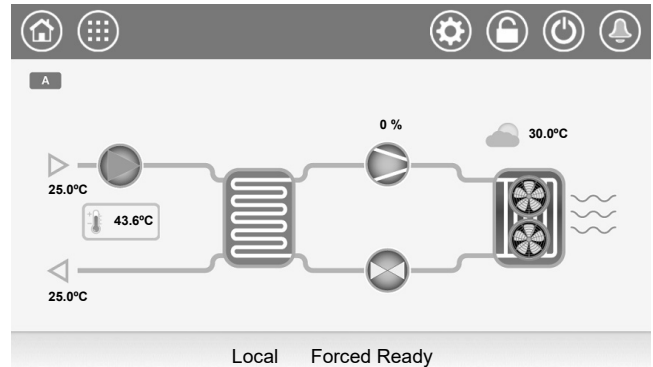

2. Select "General Parameters" .

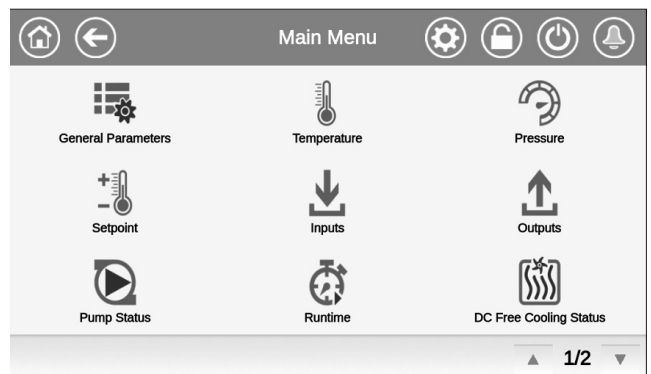

3. The General Parameters menu will be displayed.
  - The current SG Ready status is displayed on the third page ("Smart Grid Ready Status").
  - 1 = LOCK
  - 2 = NORMAL
  - 3 = BOOST
  - 4 = FORCED

GENUNIT - General Parameters		
Circuit A Total Capacity	0	%
Circuit B Total Capacity	0	%
Active Demand Limit Val	100	%
Current Setpoint	11.0	°C
Control Point	11.0	°C
Emergency Stop	Disable	
Smart Grid Ready Status	2	

Note: "Heat/Cool Select" allows you to set the unit in Heating or Cooling mode.

# 10 - APPENDIX 1: SMART GRID READY INSTALLATION INSTRUCTIONS

## 10.3.2 - LOCK operating mode

In the LOCK mode, the chiller/heat pump is in the OFF state. For units with a boiler, the boiler can be started during the lock state only when "SGR Threshold" setting allows. To start the boiler, the Outside Air Temperature (OAT) must be below the SGR Boiler OAT Threshold which is defined by the user.

### To change the SGR boiler threshold

1. Tap  to open the Main Menu.

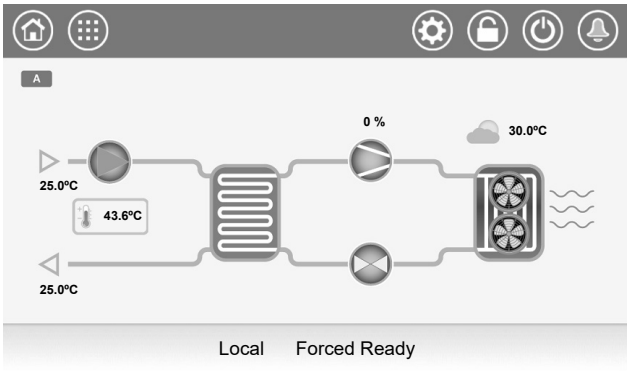

2. Go to "Configuration"  > "Heat/Cool Config" .

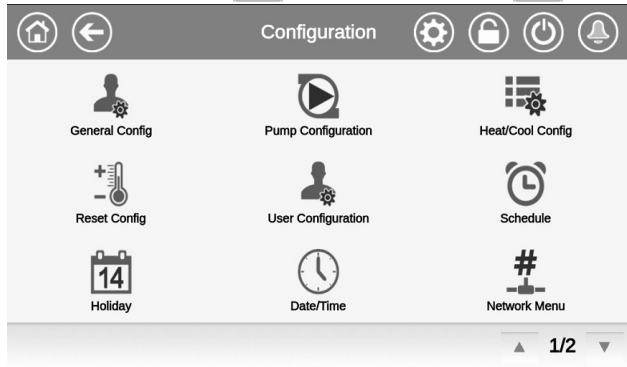

3. The Heat/Cool Configuration menu will be displayed.

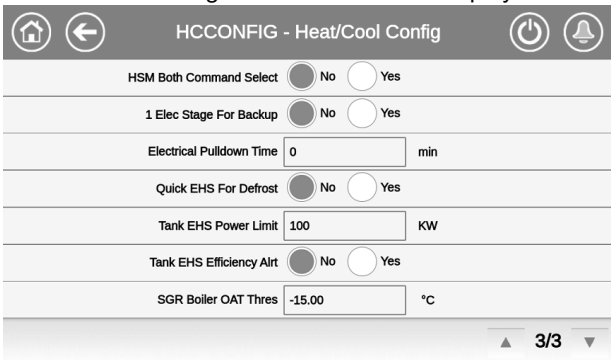

4. Set the Smart Grid threshold to start the boiler.
  - The threshold ("SGR Boiler OAT Thres") is -15°C by default.

## 10.3.3 - BOOST operating mode

In the BOOST mode, it is possible to define an offset used to adjust the water temperature setpoint.

### To set the Smart Grid offset

1. Tap  to open the Main Menu.

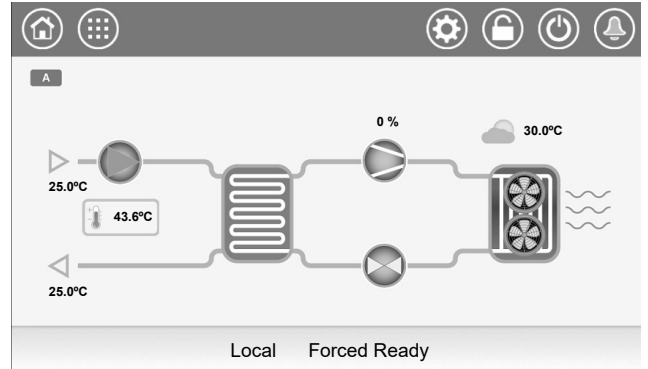

2. Go to "Configuration"  > "Reset Config" .

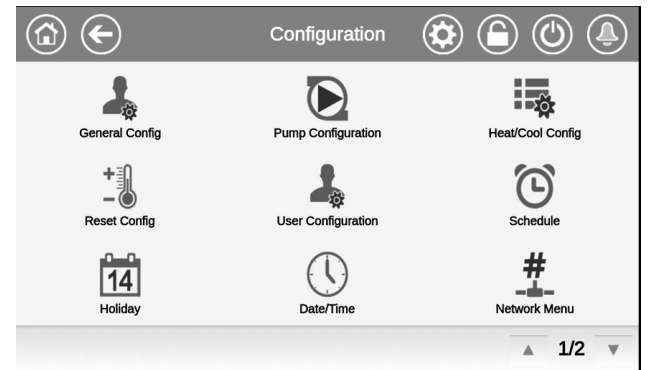

3. The Reset Configuration menu will be displayed.
  - Offset settings are displayed on the third page ("Smart Grid Ready Option").

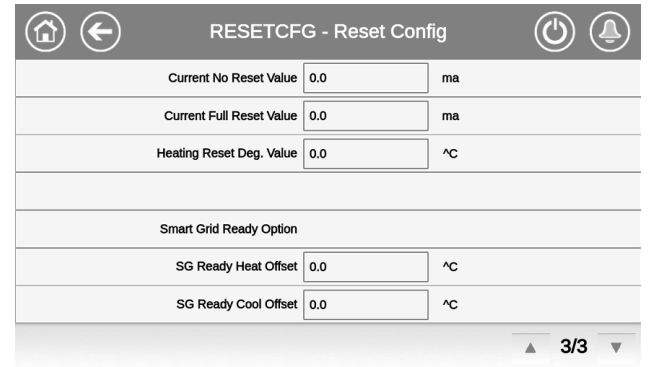

4. Set the Smart Grid offset value for Heating or Cooling mode.
  - "SG Ready Heat Offset" (0.0°C by default).
  - "SG Ready Cool Offset" (0.0°C by default).

# 10 - APPENDIX 1: SMART GRID READY INSTALLATION INSTRUCTIONS

## 10.4 - Wiring: Smart Grid connections

The Smart Grid Ready module must be connected to "LIM\_SW1" and "LIM\_SW2" inputs. These contacts are used to limit chiller/heat pump capacity and the capacity limit setpoint (lim\_sp) applied to the unit depends on the status of these contacts.

- LIM\_SW1 and SGR0\_BST are wired to DI-03 on A1A board.
- LIM\_SW2 and SGR1\_LCK are wired to DI-04 on A1A board.

By default, "lim\_sp1" and "lim\_sp3" are equal to 100%, but they can be set to other values to limit the unit capacity. When the SG Ready option is enabled, these limits are applicable in "Boost" and "Forced" operating modes.

Smart Grid status	1 = LOCK	2 =NORMAL	3 = BOOST	4 = FORCED
Capacity Limit	lim_sp2*	100%	lim_sp1	lim_sp3
SGR1_LCK	close	open	open	close
SGR0_BST	open	open	close	close

\*Lim\_sp2 becomes not applicable in the LOCK operating mode.

### 10.4.1 - Electrical diagram

SG Ready module must be wired to DI-03 and DI-04 on A1A I/O board as shown below.

#### Customer control connections

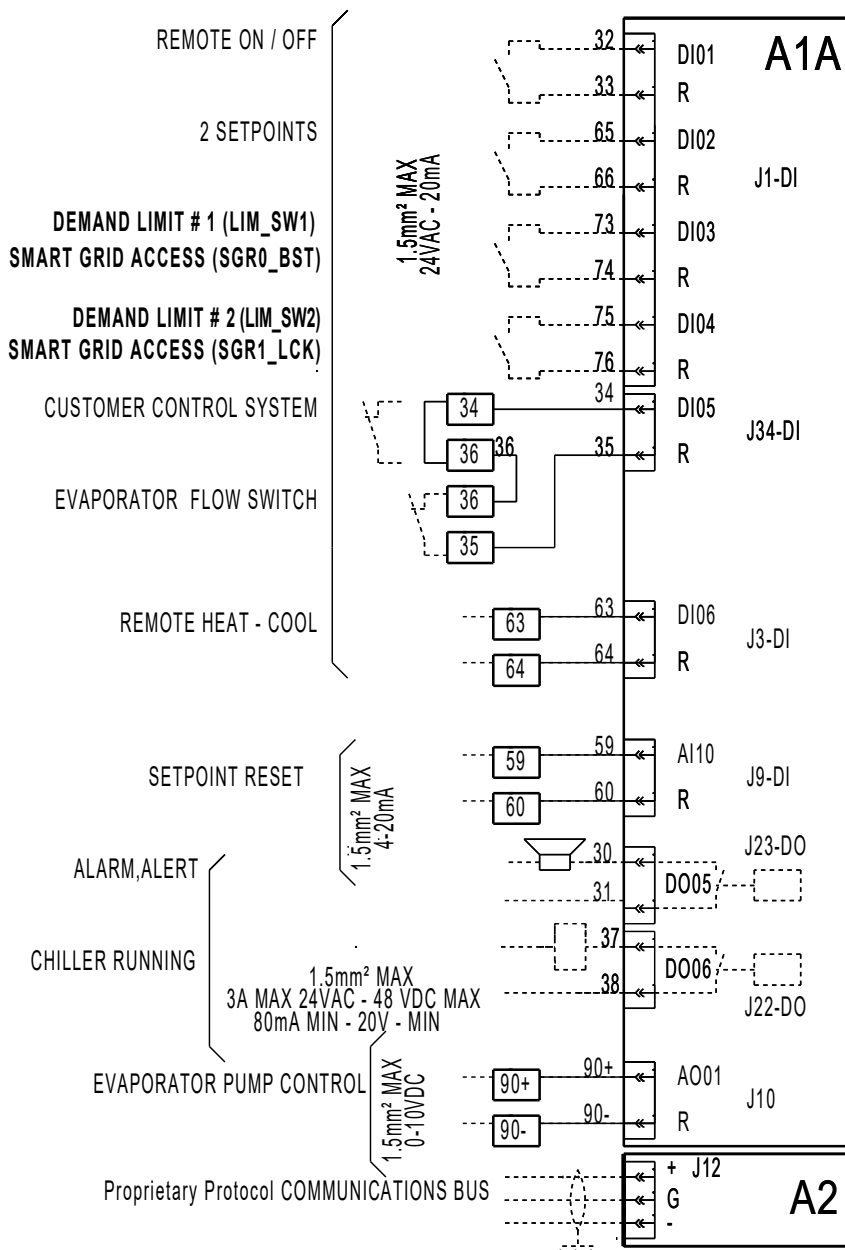

# 10 - APPENDIX 1: SMART GRID READY INSTALLATION INSTRUCTIONS

## 10.4.2 - Electrical box: Location

The terminal access for Smart Grid Inputs is located inside the electrical box of the heat pump (on the A1A board).

### Component arrangement: Control box

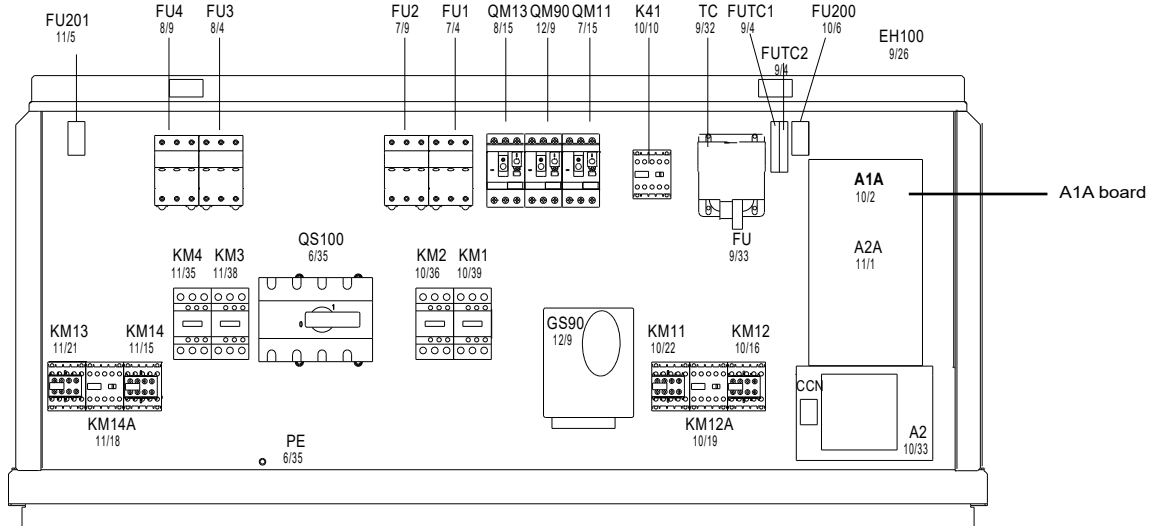

**NOTE:** The number of electrical components available on the board may differ depending on the size of the unit.

### Smart Grid connections

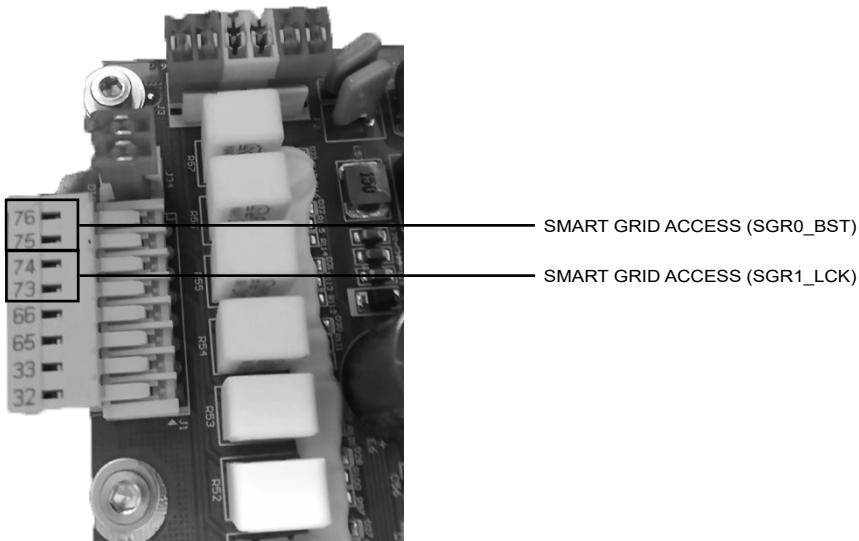

The quality management system of this product's assembly site has been certified in accordance with the requirements of the ISO 9001 standard (latest current version) after an assessment conducted by an authorized independent third party.  
The environmental management system of this product's assembly site has been certified in accordance with the requirements of the ISO 14001 standard (latest current version) after an assessment conducted by an authorized independent third party.  
The occupational health and safety management system of this product's assembly site has been certified in accordance with the requirements of the ISO 45001 standard (latest current version) after an assessment conducted by an authorized independent third party.  
Please contact your sales representative for more information.

Carrier SCS, Montluel, France.  
Manufacturer reserves the right to change any product specifications without notice.

Printed in the European Union.