

10555

05 - 2024

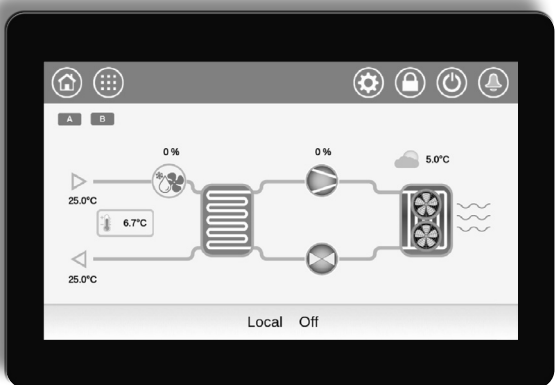
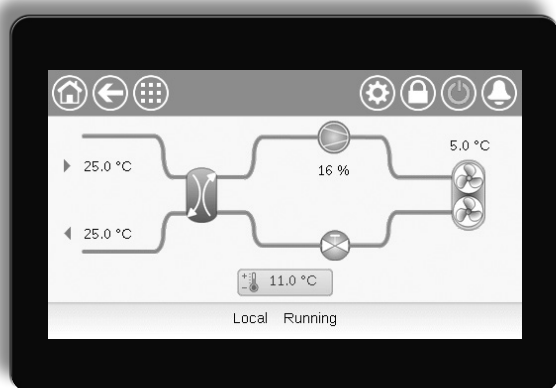

Instruction manual

AQUACIAT POWER (ILD) (602R-4000R)

CONNECT TOUCH



CONTENTS

PREFACE	3	8 - STANDARD CONTROL OPERATIONS AND OPTIONS	48
1 - SAFETY CONSIDERATIONS	4	8.1 Unit Start / Stop control.....	48
1.1 Safety guidelines	4	8.2 Heating / Cooling control	48
1.2 Safety precautions	4	8.3 Supplementary heating	49
2 - CONTROL OVERVIEW	5	8.4 Water pumps control.....	49
2.1 Control system.....	5	8.5 Hydronic kit option	50
2.2 System functionalities	5	8.6 Control point	51
2.3 Operating modes	5	8.7 Capacity limitation	52
2.4 CONNECT TOUCH control system.....	5	8.8 Controlling capacity	53
2.5 Control panel	5	8.9 Night mode	53
3 - CONTROL COMPONENTS	6	8.10 Controlling the coil pressure	53
3.1 CONNECT TOUCH overview	6	8.11 Setting holidays	54
3.2 Features overview	6	8.12 Dry cooler – free cooling option	54
4 - HARDWARE	7	8.13 Energy Management Module	54
4.1 Control boards	7	8.14 Heat recovery option (desuperheater)	54
4.2 Power supply to boards	7	8.15 Heat Reclaim (option 50)	55
4.3 Light Emitting Diodes on boards.....	7	8.16 Free Cooling (option 305A/305B/305C).....	56
4.4 Pressure transducers.....	7	8.17 Defrost cycle (heat pumps only)	57
4.5 Temperature sensors.....	8	8.18 Master/Slave control.....	57
4.6 Actuators	8	8.19 BACnet IP / BACnet MS/TP option (option 149)	57
4.7 Terminal block connections	9	8.20 Brine option (option 6)	57
4.8 RS485 wiring (best practice).....	11	8.21 Refrigerant gas leak detection option	57
5 - CONNECT TOUCH USER INTERFACE	12	8.22 Modbus (option 149B)	57
5.1 Menu structure.....	15	8.23 Cooling floor optimization (option 119C).....	57
5.2 Header buttons.....	17	8.24 Software Activation Key(s).....	58
5.3 Explore the synoptic screen.....	18	8.25 Duplex unit (2800R-4000R)	58
5.4 Start/Stop the unit.....	18	8.26 Energy Meter (option 294)	59
5.5 Set the schedule.....	19	8.27 Fast capacity recovery (option 295+).....	59
5.6 Manage display settings	20	8.29 Phase controller (option 159B)	59
5.7 Monitor unit parameters.....	21	8.30 Smart Grid Ready (option 157D)	59
5.8 Modify unit parameters	21	9 - DIAGNOSTICS	60
5.9 Override system configuration	21	9.1 Control diagnostics.....	60
5.10 Analyse history trends	22	9.2 E-mail notifications	60
6 - WEB CONNECTION	23	9.3 Alarms description.....	61
6.1 Web interface	23	10 - MAINTENANCE	69
6.2 Technical documentation.....	23	11 - APPENDIX 1: SMART GRID READY INSTALLATION INSTRUCTIONS	70
6.3 Connect Touch 2.0 web interface.....	24	11.1 Introduction.....	70
7 - CONNECT TOUCH CONTROL: MENU STRUCTURE	25	11.2 Configuration of Smart Grid Ready option	70
7.1 Main menu.....	25	11.3 Smart Grid Ready operating modes	72
7.2 Configuration menu (CONFIG)	37	11.4 Wiring: Smart Grid connections	74
7.3 Network Parameters menu	41	11.5 Electrical diagram	74
7.4 System Menu.....	44	11.6 Electrical box: Location	76
7.5 Alarm Menu	46		

PREFACE

The goal of this document is to give a broad overview of the main functions of the control system used to control AQUACIAT^{POWER} LD air-cooled liquid chillers (165 to 950 kW) and AQUACIAT^{POWER} ILD reversible heat pumps (165 to 680 kW).

Instructions in this manual are given as a guide to good practice in the installation, start-up and operation of the control system. This document does not contain full service procedures for the correct operation of the equipment.

It is possible to monitor and manage the operation of the chiller/heat pump from either a local colour touch screen panel installed in the electrical cabinet of the machine or the web interface.

- Please note that the Connect Touch display panel has been superseded by the Connect Touch 2.0 touch screen.
- The layout and design of the web interface may differ based on the type of the touch screen installed on the machine.

For units equipped with the legacy "Connect Touch" touch screen, the organisation of pages is the same both on the touch screen and the web interface.

Connect Touch 2.0 touch screen comes with the new web user interface design which allows for easy navigation across different functionalities of the control system.
- This document applies to both versions of the touch screen. Please refer to the relevant section of this document.

The support of a qualified Manufacturer Service Engineer is strongly recommended to ensure optimal operation of the equipment as well as the optimization of all available functionalities.

Note that this document may refer to optional components and certain functions, options or accessories may not be available for the specific unit.

IMPORTANT: All screenshots of the user interface provided in this manual include text in English. After changing the language of the system, all labels will be in the language selected by the user.

Please read all instructions prior to proceeding with any work. Pay attention to all safety warnings.

The information provided herein is solely for the purpose of allowing customers to operate and service the equipment and it is not to be reproduced, modified or used for any other purpose without the prior consent of the Manufacturer.

Acronyms / Abbreviations

In this manual, the refrigeration circuits are called circuit A and circuit B. Compressors in circuit A are labelled A1, A2, A3, A4, whereas compressors in circuit B are labelled B1, B2, B3, B4.

Acronym	Description
BMS	Building Management System
BPHE	Brazed Plate Heat Exchanger
DCFC	Dry Cooler Free Cooling
DST	Daylight Saving Time
DGT	Discharge Gas Temperature
EHS	Electric Heater Stage
EMEA	Europe, Middle East and Africa
EMM	Energy Management Module
EWT	Entering Water Temperature
UI	User Interface
EXV	Electronic Expansion Valve
FC	Free Cooling
HR	Heat Reclaim
HSM	Hydronic System Manager
LED	Light Emitting Diode
LWT	Leaving Water Temperature
MC	Mechanical Cooling
MCHE	Micro-Channel Heat Exchanger
OAT	Outdoor Air Temperature
PC	Phase Controller
SCT	Saturated Condensing Temperature
SST	Saturated Suction Temperature
THD	Total Harmonic Distortion
VFD	Variable Frequency Drive

Abbreviation	Description
Local-Off mode / LOFF	Operating type: Local Off
Local-On mode / L-On	Operating type: Local On
Local-Schedule mode / L-SC	Operating type: Local schedule
Master mode / Mast	Operating type: Master
Network mode / Net	Operating type: Network
Remote mode / Rem	Operating type: Remote

1 - SAFETY CONSIDERATIONS

1.1 Safety guidelines

Installation, start-up and servicing of equipment can be hazardous if certain factors particular to the installation are not considered: operating pressures, electrical components, voltages, and the installation site (elevated plinths and built-up structures).

Only qualified installation engineers and fully trained technicians are authorised to install and start up the equipment.

All instructions and recommendations provided in the service guide, installation and operation manuals, as well as on tags and labels fixed to the equipment, components and other accompanying parts supplied separately must be read, understood and followed.

Failure to comply with the instructions provided by the manufacturer may result in injury or product damage.

IMPORTANT: Only qualified service engineers should be allowed to install and service the equipment.

1.2 Safety precautions

Only personnel qualified in accordance with IEC (International Electrotechnical Commission) recommendations may be permitted access to electrical components.

It is particularly recommended that all sources of electricity to the unit should be shut off before any work is begun. Shut off the main power supply at the main circuit breaker or isolator.

IMPORTANT: The equipment uses and emits electromagnetic signals. Tests have shown that the equipment conforms to all applicable codes with respect to electromagnetic compatibility.

CAUTION

RISK OF ELECTROCUTION! Even when the main circuit breaker or isolator is switched off, specific circuits may still be energised as they may be connected to a separate power source.

CAUTION

RISK OF BURNS! Electrical currents may cause components to get hot. Handle the power cable, electrical cables and conduits, terminal box covers and motor frames with great care.

2 - CONTROL OVERVIEW

2.1 Control system

AQUACIAT^{POWER} chillers and heat pumps are equipped with the CONNECT TOUCH control that serves as a user interface and a configuration tool for controlling the chiller / heat pump operation.

AQUACIAT^{POWER} LD chillers and AQUACIAT^{POWER} ILD heat pumps are typically equipped with fixed speed fans or they may come with variable speed fans which reduce the unit energy use during occupied and unoccupied periods, provide condensing and evaporating pressure control and smooth fan start. The system may also control fixed speed pumps or variable speed pumps with a hydronic module.

IMPORTANT: *The document may refer to optional components and certain functions, options, or accessories may not be available for the specific unit. Heating option applies only to heat pumps and cooling-only units equipped with a boiler.*

2.2 System functionalities

The system controls the start-up of the compressors needed to maintain the desired heat exchanger entering and leaving water temperature. It constantly manages the operation of the fans in order to maintain the correct refrigerant pressure in each circuit and monitors safety devices that protect the unit against failure and guarantee its optimal functioning.

2.3 Operating modes

The control may operate in three independent modes:

- **Local mode:** The unit is controlled by commands from the user interface.
- **Remote mode:** The unit is controlled by dry contacts.
- **Network mode:** The unit is controlled by networks (Proprietary Protocol, BACnet IP, BACnet MS/TP option, Modbus TCP/IP, Modbus RTU). Data communication cable is used to connect the unit to the proprietary protocol communication bus.

When the control operates autonomously (Local or Remote), it retains all of its control capabilities but does not offer any features of the Network.

CAUTION

Emergency stop! The Network emergency stop command stops the unit regardless of its active operating type.

2.4 CONNECT TOUCH control system

- Allows users to control the unit via the CONNECT TOUCH user interface.
- Provides web connectivity technology.
- Includes the trending functionality.
- Supports Enhanced Control Management (BluEdge Digital, Cristo'Control2, Power'Control, Smart CIATControl) for multiple chillers/heat pump configuration.
- Provides direct BMS integration capabilities (Modbus RTU, Modbus TCP/IP, BACnet/IP option or Lon option).

2.5 Control panel

Navigation through the Connect Touch control is either using the touch screen interface or by connecting to the web interface.

The legacy Connect Touch display panel has been superseded by the Connect Touch 2.0 touch screen.

Connect Touch touch screen	Connect Touch 2.0 touch screen
a resistive LCD touch screen	a capacitive LCD screen
the same layout of menus on the touch screen and the web UI	new web user interface design (web UI design different from the touch screen display)
CEPL131228-01-R*	CEPL131256-01-R*

* The CEPL number can be found on the sticker on the back of the touch screen.

3 - CONTROL COMPONENTS

3.1 CONNECT TOUCH overview

The CONNECT TOUCH system manages a number of mechanisms allowing the unit to operate effectively, including variable speed fans control, fixed or variable speed pumps control, etc.

The CONNECT TOUCH control system is used to control the following types of AQUACIAT^{POWER} range units:

AQUACIAT ^{POWER} LD	Cooling-only air-cooled chillers
AQUACIAT ^{POWER} ILD	Air-to-water reversible heat pumps

3.2 Features overview

Feature	Cooling-only Chillers	Reversible Heat Pumps
BMS connection	●	●
4.3" touch screen	●	●
Web connectivity	●	●
E-mail transmission	●	●
Occupied / Unoccupied mode management	●	●
Trending	●	●
Master/Slave control	●	●
Diagnostics	●	●
Cooling control	●	●
Free cooling (dry cooler mgmt.)	○	○
Heating control	-	●
Boiler heating control	-	-
Electric heating control	-	-
Partial heat recovery / desuperheater (option 49)	○	○
Heat Reclaim (option 50)	○	
Heat Reclaim condenser heater (option 41C)	○	
Defrost mechanism	-	●
Free defrost control	-	●
Brine fluid	○	-
Refrigerant leak detection	○	○
Fixed speed fans	●	●
Variable speed fans	○	○
XtraFan	○	○
Anti-freeze protection	○	○
Fixed speed pump(s)	○	○
Variable speed pump(s)	○	○
Cooling Floor Optimization (option 119C)	-	○
Hydraulic Free Cooling (option 305A/305B/305C)	○	-
Duplex unit option (2800R-4000R)	-	○
Phase controller (option 159B)	○	○
Energy Meter (option 294)	○	○
Fast capacity recovery (option 295+)	○	-
Smart Grid Ready * (option 157D)	○	○
Communication		
Proprietary protocol	●	●
Modbus RTU or TCP/IP	●	●
BACnet IP	○	○
BACnet MS/TP communication (Connect Touch 2.0)	○	○
LonTalk	○	○

* The Smart Grid Ready label is valid only in the DACH region (Germany, Austria, Switzerland).

●	Supplied as standard
○	Option
-	Not available

4 - HARDWARE

4.1 Control boards

The electrical box includes all boards controlling the unit as well as the CONNECT TOUCH user interface.

Each circuit is by default fitted with one SIOB/CIOB board used to manage all major inputs and outputs of the controller. Options such as energy management module or free cooling (dry cooler management) require the installation of additional boards, i.e. EMM SIOB/CIOB board for energy management module and FC dry cooler board for free cooling. Additionally, units with seven or eight fixed speed fans are fitted with an additional auxiliary 2 board "AUX2 board". Chillers with the Heat Reclaim option come with an additional AUX1 board.

All boards communicate via an internal bus.

4.2 Power supply to boards

All boards are supplied from a common 24 VAC supply referred to earth.

CAUTION

Maintain correct polarity (and grounded 0V) when connecting the power supply to the boards, otherwise the boards may be damaged.

In the event of a power supply interrupt, the unit restarts automatically without the need for an external command. However, any faults active when the supply is interrupted are saved and may in certain cases prevent a given circuit or the unit from restarting.

The main board continuously monitors the information received from various pressure and temperature probes and accordingly starts the program that controls the unit.

The number of boards available in the electrical box depends on the number of selected options.

4.3 Light Emitting Diodes on boards

All boards continuously check and indicate the proper operation of their electronic circuits. A light emitting diode (LED) lights on each board when it is operating properly.

- The red LED flashing for a two-second period indicates correct operation. A different rate indicates a board or a software failure.
- The green LED flashes continuously on all boards to show that the board is communicating correctly over its internal bus. If the green LED is not flashing, this indicates the internal bus wiring problem or a configuration issue.

4.4 Pressure transducers

Three types of transducers (high pressure, low pressure, water pressure) are used to measure various pressures in each circuit. These transducers deliver 0 to 5 VDC. They are connected to SIOB/CIOB boards (circuit A and circuit B).

Discharge pressure transducers (high pressure type)

These transducers measure the discharge pressure in each circuit. They are used to control condensing pressure or high pressure load shedding. Discharge pressure sensors are mounted on the discharge line piping of each circuit.

Suction pressure transducers (low pressure type)

These transducers measure the suction pressure in each circuit. They are used to control EXV, evaporating pressure (in heating mode) and monitor suction pressure safeties related to the compressor operating envelope. Suction pressure sensors are located on the common suction piping of each circuit.

Pump inlet/outlet water pressure transducers (water pressure type, hydronic kit option)

These transducers measure the hydronic kit pump inlet/outlet water pressure and monitor the water flow. Pump inlet/outlet water pressure sensors are mounted on the optional hydronic kit.

Pump inlet/outlet pressure transducers (Free Cooling option, 305A/305B/305C)

These transducers measure the free cooling refrigerant pump inlet and outlet pressure. They are used to control pump start-up and monitor pump pressure during the free cooling cycle.

Pump inlet/outlet pressure transducers (Free Cooling option, 305C)

Two pressure transducers located at the output of the Glycol-Free BPHE (before [fc_ewp] and after the pump [fc_lwp]) allow for measuring the flow of the glycol-water mixture on the Free Cooling side.

4 - HARDWARE

4.5 Temperature sensors

Temperature sensors constantly measure the temperature of various components of the unit, ensuring the correct operation of the system.

Water heat exchanger entering and leaving water temperature sensors

The water heat exchanger entering and leaving water temperature sensors are used for capacity control and safety purposes.

Outdoor air temperature sensor

This sensor measuring the outdoor air temperature is used for start-up, setpoint temperature reset and frost control.

Suction gas temperature sensors

These sensors measure the suction gas temperature. They are used for the EXV control. Suction gas temperature sensors are located at the suction side of each circuit.

Master/slave water sensor (optional)

This sensor measures the common water temperature in the master/slave system capacity control. It is installed only in the case of master/slave units.

Defrost temperature sensors (heat pumps)

These sensors are used to determine the end of the defrost cycle for a given circuit.

Temperature setpoint reset sensor (Energy Management Module)

This sensor measures the space (room) temperature for the purpose of setpoint reset.

Heat Reclaim leaving water temperature sensor (HR option)

This factory-mounted temperature sensor is located on the BPHE condenser outlet. It measures the water temperature leaving the condenser and it is used to determine the activation of the heat recovery.

Heat Reclaim control water temperature sensor (HR option)

This water temperature sensor is used to measure the water temperature on the customer side and it is located either before or after the 3 way-valve. In case the variable-speed pump is used instead of the 3-way valve, then this sensor is located on the BPHE condenser inlet.

Free Cooling water temperature sensor (FC option, 305A/305B/305C)

The Free Cooling water temperature sensor is located at the output of Free Cooling coils and at the input of the water exchanger. This sensor is used to control the Free Cooling capacity.

Free Cooling glycol-water temperature sensor (FC option, 305C)

This sensor located at the input of the Glycol-Free BPHE is used to measure the temperature of the glycol-water mixture in Free Cooling coils (TEMP, FC_WGT).

4.6 Actuators

Electronic expansion valve

The electronic expansion valve (EXV) is used to adjust the refrigerant flow to changes in the operating conditions of the machine. The high degree of accuracy with which the piston is positioned provides precise control of the refrigerant flow and suction superheat.

Water flow switch

For units without internal pumps, a flow switch is mounted to ensure that the minimum flow rate required for the correct operation and protection of the system is maintained.

The minimum flow rate threshold depends on the unit size and is configured automatically at the start-up. If the flow switch fails, the alarm condition shuts off the unit.

Water heat exchanger pumps (optional)

The controller can regulate one or two fixed speed or variable speed water heat exchanger pumps and takes care of the automatic changeover between these pumps.

Four-way valve (heat pumps)

The control actuates the four-way valve for cooling / heating mode and defrosts' sessions.

Three-way valve (HR option) *

The controller actuates the three-way valve to let the water flow through the Heat Reclaim condenser.

Variable-speed pump (HR option) *

The controller can regulate the variable-speed pump (0-10V) to control the Heat Reclaim condenser water flow.

**The customer can connect either a 3-way valve or a variable-speed pump. These actuators are not provided by the Manufacturer!*

Heat Reclaim flow switch (HR option)

This Heat Reclaim flow switch is used to detect water flow inside the BPHE condenser. This flow switch is not provided by the Manufacturer.

FC valves (FC option, 305A/305B)

The control actuates two "Free Cooling" valves (evaporator valve and coil valve) to enable/disable the optional Free Cooling subset. In Free Cooling, with the evaporator valve closed and the coil valve open, the process water will go directly through Free Cooling coils where cooled with the low temperature ambient air.

FC coil pump (FC option, 305C)

This fixed-speed pump is located at the output of the glycol-free BPHE is used to control the closed glycol-water loop on the Free Cooling side.

4 - HARDWARE

4.7 Terminal block connections

Connections available at the user terminal block may vary depending on the selected options. The following table summarizes connections at the user terminal block.

IMPORTANT: Some contacts can be accessed only when the unit operates in Remote mode.

Terminal block connections				
Description	Board	Input/Output	Connector	Remarks
On/Off switch	SIOB/CIOB, circuit A	DI-01	J1	Used for the unit On/Off control (Remote mode)
Heat/Cool switch	SIOB/CIOB, circuit A	DI-04	J1	Used to switch between cooling and heating when the unit is in Remote mode (Heat pumps only)
Second setpoint switch	SIOB/CIOB, circuit A	DI-02	J1	Used to switch between setpoints
Demand limit switch 1	SIOB/CIOB, circuit A	DI-03	J1	Used to control demand limit
SG Ready access (SGR0_BST)	SIOB/CIOB, circuit A	DI-03	J1	Used to control SG Ready option
Alarm relay	SIOB/CIOB, circuit A	DO-05	J23	Indicates alarms
Running relay	SIOB/CIOB, circuit A	DO-06	J22	Used to signal a running status (at least one compressor started)
Desuperheater demand	SIOB/CIOB, circuit B	DI-04	J1	Heat recovery is allowed (option 49)
Lock switch	SIOB/CIOB, circuit B	DI-02	J1	Used for the customer safety loops
Customer pump 1	SIOB/CIOB, circuit B	DO-05	J23	The control can regulate one or two evaporator pumps and automatically change over between the two pumps
Customer pump 2	SIOB/CIOB, circuit B	DO-06	J22	The control can regulate one or two evaporator pumps and automatically change over between the two pumps
Optional				
Setpoint reset control	SIOB/CIOB, circuit A	AI-10	J9	Allows the user to reset the currently selected setpoint
Phase controller	CIOB, circuit A	AI-11	J45	The phase controller (option 159B) is used to monitor the main supply of the unit: The phase controller relay output is connected to the analogue input on the CIOB board. <i>Note: This option is NOT compatible with the SIOB board.</i>
Occupancy override	SIOB/CIOB, EMM	DI-01	J1	Used to switch between occupied (closed contact) and unoccupied mode (open contact)
Demand limit switch 2	SIOB/CIOB, EMM	DI-02	J1	Used to control demand limit
SG Ready access (SGR1_LCK)	SIOB/CIOB, EMM	DI-02	J1	Used to control SG Ready option
Customer interlock	SIOB/CIOB, EMM	DI-03	J1	Used for the customer safety loops
Ice done contact	SIOB/CIOB, EMM	DI-04	J1	Used to control the setpoint for ice storage in unoccupied mode
FC Evaporator Valve Closed? (4" valve)	SIOB/CIOB, EMM	DI-05	J34	Used to control the hydraulic free cooling option
FC Evaporator Valve Opened? (4" valve)	SIOB/CIOB, EMM	DI-06	J3	Used to control the hydraulic free cooling option
FC Coil Valve Closed? (4" valve)	SIOB/CIOB, EMM	DI-07	J3	Used to control the hydraulic free cooling option
FC Coil Valve Opened? (4" valve)	SIOB/CIOB, EMM	DI-08	J3	Used to control the hydraulic free cooling option
Space Temperature	SIOB/CIOB, EMM	AI-01	J25-J40	Used for reset control (option 156)
FC evaporator water temperature	SIOB/CIOB, EMM	AI-02	J25-J41	Used for hydraulic free cooling control (option 305A/305B/305C)
FC glycol water temperature	SIOB/CIOB, EMM	AI-03	J25-J41	Used for hydraulic free cooling control (option 305C)
Free Cooling inlet pump pressure	SIOB/CIOB, EMM	AI-06	J11	Used for hydraulic free cooling control (option 305C)
Free Cooling outlet pump pressure	SIOB/CIOB, EMM	AI-07	J19	Used for hydraulic free cooling control (option 305C)
Capacity limit control	SIOB/CIOB, EMM	AI-10	J9	Used for capacity limitation
FC evaporator valve close command (3" valve)	SIOB/CIOB, EMM	DO-01	J2	Used to control the hydraulic free cooling option
FC evaporator valve open command (3" valve)	SIOB/CIOB, EMM	DO-02	J2	Used to control the hydraulic free cooling option
FC coil Valve close command (3" valve)	SIOB/CIOB, EMM	DO-03	J6	Used to control the hydraulic free cooling option
FC coil valve open command (3" valve)	SIOB/CIOB, EMM	DO-04	J6	Used to control the hydraulic free cooling option
Chiller partially shutdown	SIOB/CIOB, EMM	DO-05	J23	Indicates the shutdown of one of the circuits
Electric Heater Stage #1	SIOB/CIOB, EMM	DO-07	J7	Used to activate electric heating stage #1
Boiler	SIOB/CIOB, EMM	DO-07	J7	Used to control the boiler
Electric Heater Stage #2	SIOB/CIOB, EMM	DO-08	J7	Used to activate electric heating stage #2
Electric Heater Stage #3	SIOB/CIOB, EMM	DO-09	J7	Used to activate electric heating stage #3
Electric Heater Stage #4	SIOB/CIOB, EMM	DO-10	J7	Used to activate electric heating stage #4
Chiller capacity running output (0 to 10 V)	SIOB/CIOB, EMM	AO-01	J10	Reports the capacity percentage of the unit

4 - HARDWARE

Terminal block connections				
Description	Board	Input/Output	Connector	Remarks
Desuperheater customer pump	SIOB/CIOB, EMM	DO-01	J2	The control can regulate a customer pump for heat recovery. The connection has to be done between the pin DO-01 of connector J2 and the pin IN-01 of connector J4
		IN-01	J4	
Heat Reclaim BPHE heater	AUX1, HR	DO-01	J2	Used to activate the optional HR condenser heater
Heat Reclaim pump command	AUX1, HR	DO-02	J2	Used to energize the HR pump
Heat Reclaim controlled water temperature	AUX1, HR	AI-01	J6	Used to monitor the controlled water temperature (on the customer side)
Heat Reclaim leaving fluid temperature	AUX1, HR	AI-02	J6	Used to monitor the HR condenser leaving water temperature
Heat Reclaim flow switch	AUX1, HR	AI-03	J7	Used to detect if the water flows in the BPHE condenser
Remote Heat Reclaim switch	AUX1, HR	AI-04	J8	Used to enable the Heat Reclaim mode (Remote mode) closed = Heat Reclaim is enabled

4.7.1 Volt-free contact (on/off and cooling/heating)

For chillers with a boiler or heat pumps, on/off contacts and cooling/heating contacts are as follows:

	Off	Cooling	Heating	Auto
On/Off contact	open	closed	closed	open
Cooling/heating contact	open	open	closed	closed

Off: Unit is stopped
Cooling: Unit is allowed to start in Cooling
Heating: Unit is allowed to start in Heating (chiller with boiler control or heat pump)
Auto: Unit can run in Cooling or Heating in accordance with the changeover values. If the automatic changeover is enabled (Heat/Cool Select, GENUNIT – General Parameters), the operating mode is selected based on OAT.

4.7.2 Volt-free setpoint selection contact

This dry contact is used to switch between setpoints. It is active only when the control is in Remote mode.

	Cooling			Heating		
	Stp1	Stp2	Auto	Stp1	Stp2	Auto
Setpoint selection contact	open	closed	-	open	closed	-

4.7.3 Volt-free demand limit selection contact

Up to two dry contacts can be used to limit unit capacity. Note that the second contact is available only for units with the energy management module.

Capacity limitation with two contacts is as follows:

	100%	Limit 1	Limit 2	Limit 3
Demand limit 1 contact	open	closed	open	closed
Demand limit 2 contact	open	open	closed	closed

Please note that limit thresholds can be defined via the user interface in the Setpoint menu (see section 7.1).

NOTE: For units with SG Ready option enabled, the capacity limit applied to the unit depends on the Smart Grid operating mode.

4.7.4 Ice storage (Energy Management Module)

For units with the optional Energy Management Module, the control includes an additional setpoint (Ice setpoint) used for ice storage control.

	Cooling setpoint		
	CSP1	CSP2	ICE_STP
Occupancy schedule	occupied	unoccupied	unoccupied
Ice done switch	open/closed	closed	open

4.7.5 Hydraulic Free Cooling contacts

Two two-way valves ("FC evaporator valve" and "FC coil valve") are used to isolate or add the Free Cooling subset. Depending on the unit size, there are two types of on/off valves:

On/Off valve	Unit size
3-inch valve	602 to 1600
4-inch valve	1750 to 3500

When Free Cooling is enabled (option 305A/305B):

- FC evaporator valve = closed, FC coil valve = open.

When Free Cooling is disabled (option 305A/305B):

- FC evaporator valve = open, FC coil valve = closed.

4 - HARDWARE

4.8 RS485 wiring (best practice)

For RS485 ports, one of the following cables can be used:

- For Proprietary Protocol or Modbus communication which is over 300 m or in a noisy environment with Variable Frequency Drive (VFD), a cable with two twisted pairs is recommended. For example, Belden 3106A or Alpha Wire 6454.
- For applications where the length of the cable is up to 300 m and there is no Variable Frequency Drive (VFD), it is possible to use cost-effective cable solutions, for example, Belden 8772.

Note that “+” and “-” are communication signals and they are from the same twisted pair.

The signal ground could be a single wire or a twisted pair and it should be connected to the “C” pin of J10 (Modbus RTU) or J7 (Proprietary Protocol). This wire is required so that all nodes on the bus share a common ground reference connection.

If a shield is used, then the shield cable should be properly terminated and connected as short as possible at ONLY ONE END to the chassis ground (4.3-inch controllers).

4.8.1 RS485 wiring: 4.3-inch controller

The following diagrams illustrate possible RS485 wiring schemes for 4.3-inch controllers.

The first wiring scheme is the best option (RECOMMENDED), but the second or the third wiring can also be used.

4.8.2 RS485: Daisy chain configuration

The following illustration shows proper 3-wire termination with a shield in a daisy chain configuration.

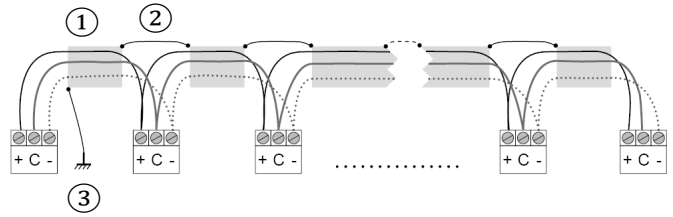

Legend

- ① Shield
- ② Keep shield continued
- ③ Connect shield to earth ground only at one point

End of Line Resistor: Termination is only needed when running at bus at very high speed over long distances.

The speed of the bus and the cable distance determines whether termination is needed. It is meant to balance the bus to minimize the ringing that may be caused by fast signals and the inductance of the cabling.

At 9600 baud, termination will have little or no effect on the bus.

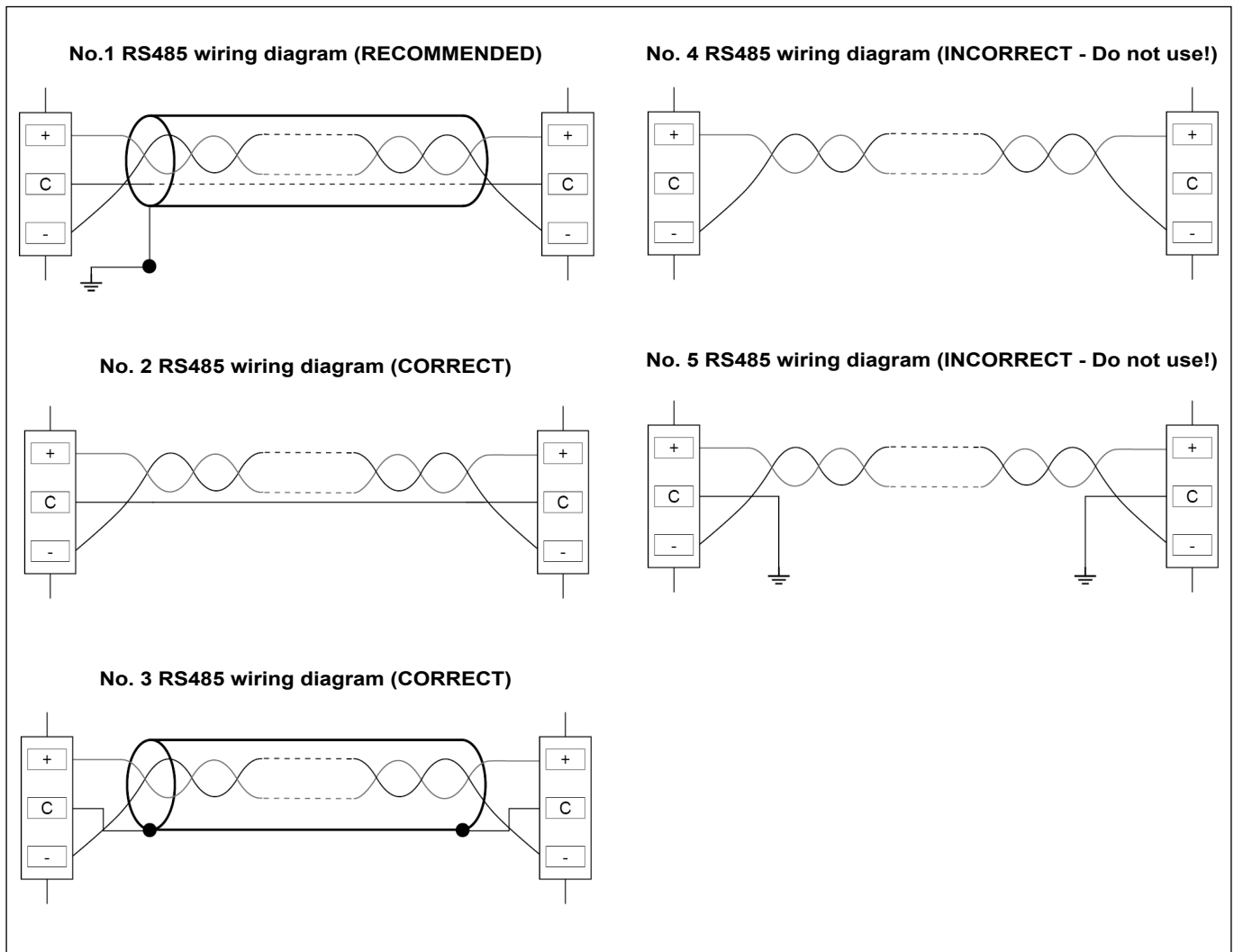

5 - CONNECT TOUCH USER INTERFACE

The Connect Touch display panel has been superseded by the Connect Touch 2.0 touch screen. The look of the display may slightly differ depending on the version of the touch screen that has been installed on the machine.

CONNECT TOUCH

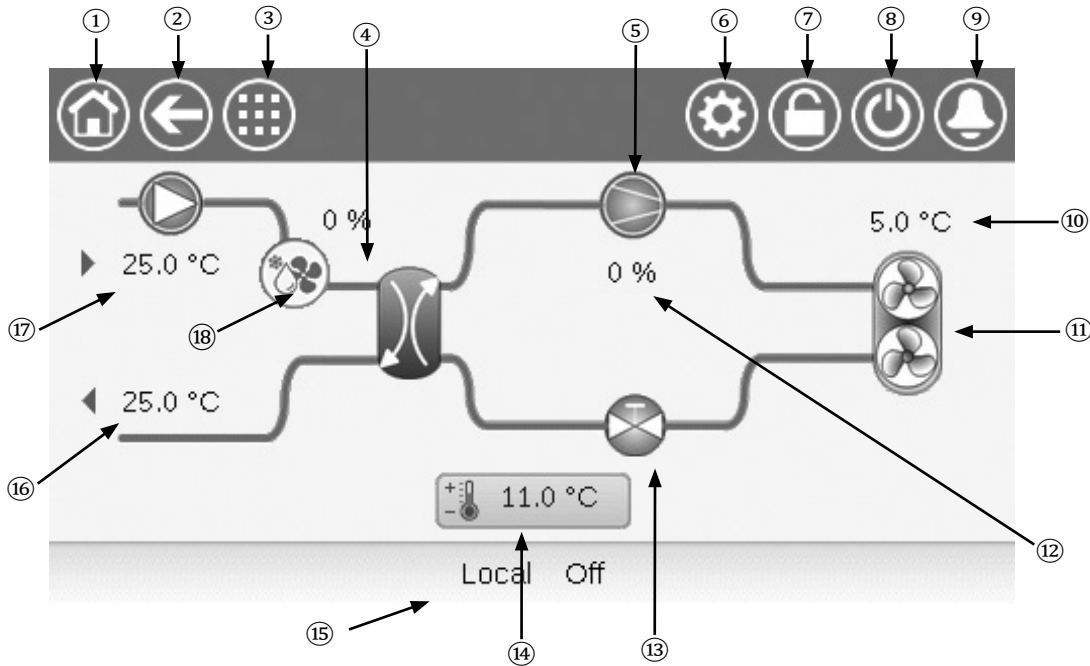

- | | |
|---|-------------------------------------|
| ① Home button | ⑩ OAT (Outdoor Air Temperature) |
| ② Back button | ⑪ Condenser fans |
| ③ Main menu button | ⑫ Unit capacity |
| ④ Heat exchanger | ⑬ EXV (Electronic Expansion Valve) |
| ⑤ Compressor | ⑭ Setpoint |
| ⑥ System menu | ⑮ Unit status |
| ⑦ Login button (restricted access to menus) | ⑯ LWT (Leaving Water Temperature) |
| ⑧ Start/Stop button | ⑰ EWT (Entering Water Temperature) |
| ⑨ Alarm button | ⑱ Free Cooling capacity (FC option) |

Features of CONNECT TOUCH user interface

- 4.3" colour touch screen with quick display of alarms, current unit operating status, etc.
- Resistive touch screen technology
- Trending capability
- Web connectivity
- Custom language support

CAUTION

If the touch screen is not used for a long period of time, the screen it goes blank. The control is always active and the operating mode remains unchanged. Press anywhere on the screen and the Welcome screen will be displayed.

5 - CONNECT TOUCH USER INTERFACE

CONNECT TOUCH 2.0

Connect Touch 2.0 touch screen comes with a refreshed home screen design. You can control the touch screen with a bare finger or a suitable pen (a capacitive stylus pen). Pointed or cutting tools should not be used (e.g. screwdrivers).

Home screen

The home screen is the first screen displayed on the touch screen panel. This screen allows you to monitor basic information about the operation of the chiller and its working conditions.

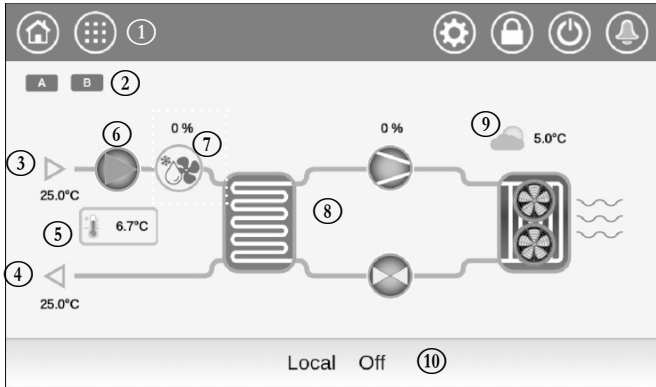

Legend:

- | | |
|---------------------------------|------------------------------|
| ① Header buttons ("header bar") | ⑥ Water pump |
| ② Circuit icon | ⑦ FC capacity |
| ③ Entering Water Temperature | ⑧ Refrigeration cycle |
| ④ Leaving Water Temperature | ⑨ Outdoor Air Temperature |
| ⑤ Setpoint | ⑩ Message box ("bottom bar") |

■ Circuit

For single-circuit chillers, there is only one circuit icon displayed (A for circuit A).

For dual-circuit chillers, two circuit icons will be displayed (A for circuit A, B for circuit B).

- Grey circuit icon = circuit is stopped
- Green circuit icon = circuit is running

■ Evaporator Entering Water Temperature (EWT)

This is the temperature of the water returned from the building ("return water temperature").

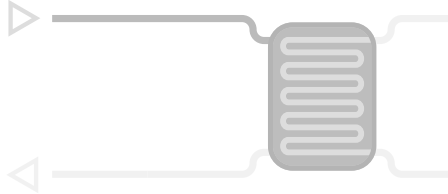

■ Evaporator Leaving Water Temperature (LWT)

This is the temperature of the chilled water produced by the chiller and supplied to the building ("supply water temperature").

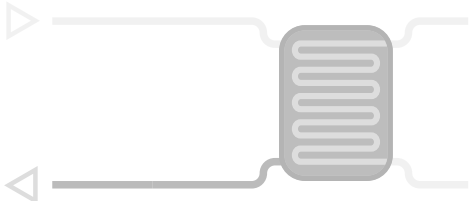

■ Setpoint

Setpoint is used to define the desired supply water temperature (Evaporator LWT).



Logged-in users are allowed to access chiller setpoint settings directly from the home screen: Tap  to open the setpoint configuration menu.

■ Water pump

A single-speed or variable-speed pump is used to circulate the working fluid through the equipment.

- Green pump icon = pump is running
- Grey pump icon = pump is stopped



Logged-in users can access pump parameters directly from the home screen: Tap  to open the pump menu.

■ Free Cooling capacity (optional)

This value shows Free Cooling capacity.



The "Free Cooling" capacity icon is displayed only for units with the Free Cooling option.

■ Refrigeration cycle (Cooling mode)

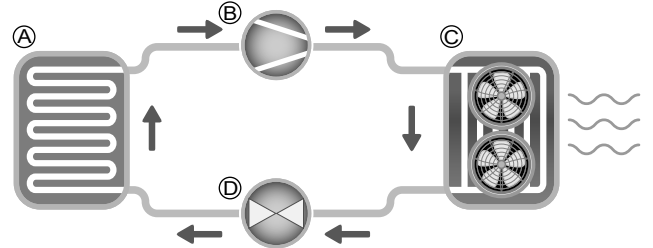

A) Evaporator

- Evaporator absorbs heat from the fluid (pure water or brine), it does the opposite of the condenser which is rejecting the heat out of the unit. Evaporator converts liquid refrigerant into vapours.

B) Compressor / circuit capacity

- This value shows current unit capacity.
- The compressor is used to squeeze the compressor refrigerant gas and turn it into high pressure gas.

C) Condenser

- Condenser is a heat exchanger used to reject the heat by cooling down the high pressure gases and taking advantage to condense the vapours into a liquid.

The number of fans given in the picture may be different from the actual number of fans installed on the unit.

D) Electronic Expansion Valve (EXV)

- EXV is used to control the flow of refrigerant into the evaporator.
- Valve position is given in %, where 0% means closed position and 100% means open position.

■ Outdoor Air Temperature

 OAT sensor reading. The outdoor air temperature sensor used to measure and monitor the temperature helps to optimize the cooling process whenever possible.

5 - CONNECT TOUCH USER INTERFACE

Connections

Connections are located on the bottom of the controller.

- The control offers RS485 communication protocols such as LEN, Proprietary Protocol, Modbus RTU.
- One Ethernet port allows for TCP/IP communication (BACnet, Modbus TCP/IP etc.) or BMS (Building Management System) connection.

The position of connectors varies depending on the model of the touch screen. For example, J8 and J10 connectors are placed in the opposite order (left/right position).

Connections of Connect Touch display

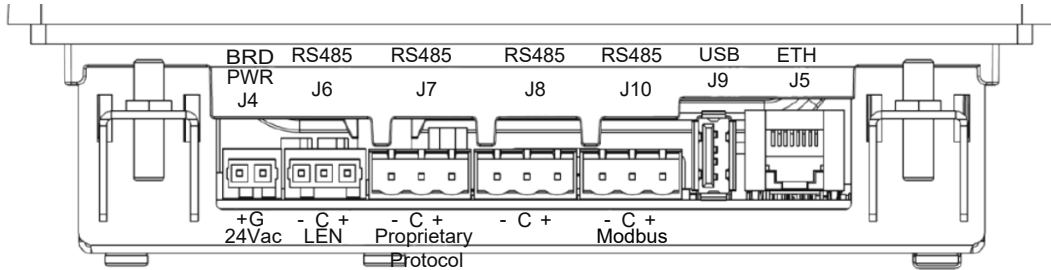

Connections of Connect Touch 2.0 display

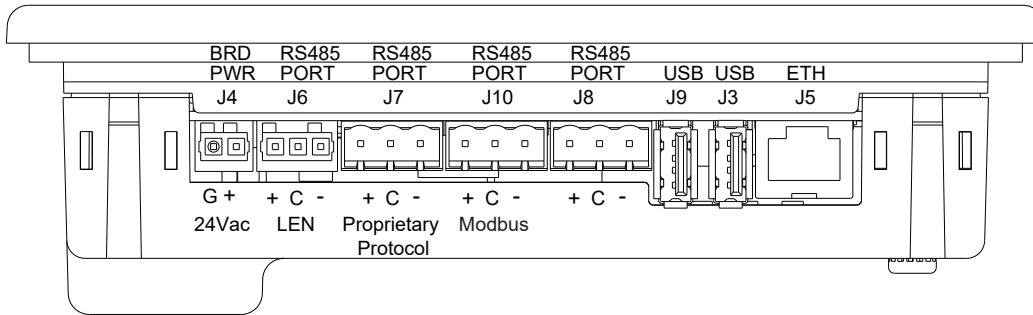

Important:

J8: This connector is used for internal communication, for example, the optional Energy Meter. This connector should not be used by the customer for any other purposes.

J10: This connector is used for Modbus (RS485) or BACnet MS/TP (RS485).

NOTE: BACnet MS/TP option is available only on Connect Touch 2.0.

5 - CONNECT TOUCH USER INTERFACE

5.1 Menu structure

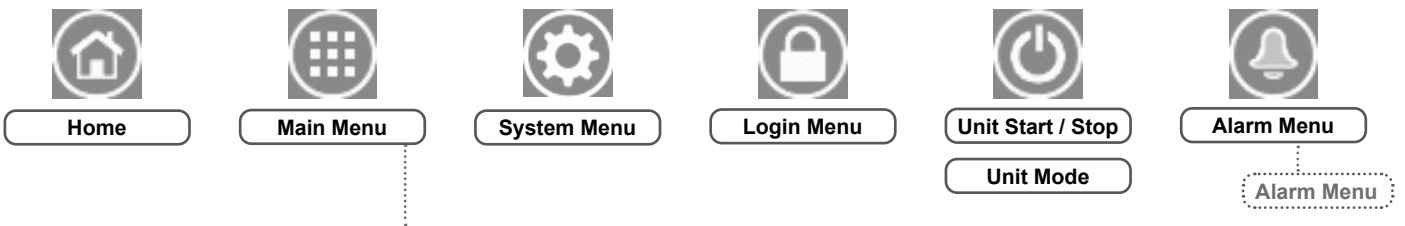

Main Menu

	General Parameters		Temperatures		Pressures
	Inputs		Outputs		Pump Status
	Run Times		Modes		DC Free Cooling Status
	Msc Status		Heat Reclaim		Hydraulic Free Cooling
	Setpoint Configuration		Configuration Menu		Quick Test #1
	Trendings		Energy Monitoring		Software Options

Configuration Menu

	General Configuration		Pump Configuration		Reset Configuration
	Backup Configuration		User Configuration		Schedule Menu
	Holiday Menu		Date/Time Configuration		Network Menu
	Control Identification		Add Options		Heat Reclaim Config

Network Menu

	Email Configuration		Modbus RTU Config.
	Modbus TCP/IP Config.		BACnet Config.

Legend:

No password required

User password required
(default password =11)

5 - CONNECT TOUCH USER INTERFACE

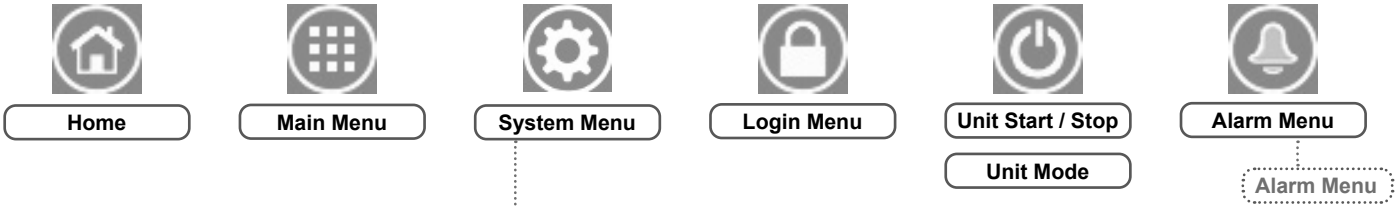

System Menu

CPU Load	EOL Resistor	Network
Date/Time Configuration	Language & Unit System	Brightness
Software Info	Hardware Info	





Alarm Menu







Reset Alarms	Current Alarms
Alarm History	Major Alarm History

5 - CONNECT TOUCH USER INTERFACE



5.2 Header buttons





HOME SCREEN

Home button	Back button	Main Menu button	System Menu button
 Home screen displayed	 Go back to the previous screen	 Main Menu displayed	 System Menu displayed

Login button	Start/Stop button	Alarm button
 Basic access	 Unit is stopped	 No alarm active on the unit
 User access	 Unit is running	 <u>Blinking icon</u> : Partial alarm (one circuit affected by the existing alarm) or Alert (no action taken on the unit)  <u>Steady icon</u> : Alarm(s) active on the unit

OTHER SCREENS

Login screen	Parameters screen(s)
 Login: Confirm advanced access login	 Save changes
 Logout: Reset the user level access and go to the splash screen	 Cancel your modifications

Force screen (override)	Navigation buttons
 Set force: Override the current command (if possible)	 4/4 Displayed when the menu includes more than one page: Go to the previous page
 Remove force: Remove the forced command	 4/4 Displayed when the menu includes more than one page: Go to the next page

5 - CONNECT TOUCH USER INTERFACE

5.3 Explore the synoptic screen

The Synoptic screen allows you to monitor the vapour-refrigeration cycle. The diagram indicates the current status of the unit, giving information on the unit capacity, the status of water heat exchanger pumps, and the pre-defined setpoint parameter.

All unit functions can be accessed by pressing the **Main menu** button.

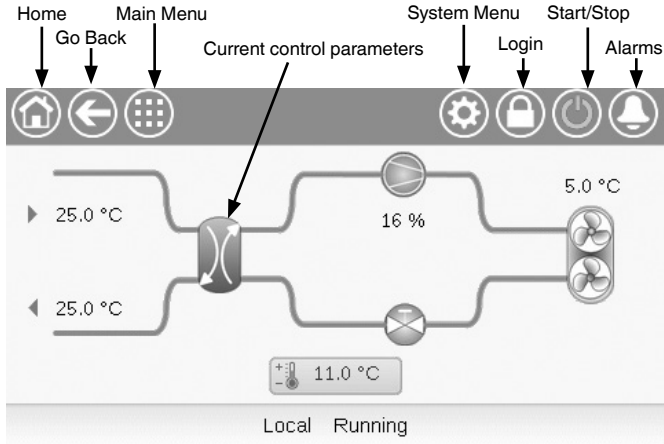

Connect Touch 2.0

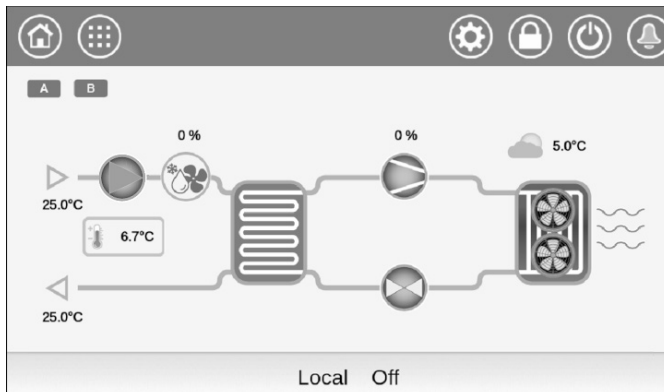

IMPORTANT: The Synoptic screen display may vary depending on pumps configuration.



The bell located in the upper-right part of the screen lights when any fault is detected.

5.4 Start/Stop the unit

With the unit in the Local off mode:

To display the list of operating modes and select the required mode, press the **Start/Stop** button  in the upper-right corner of the Synoptic screen.

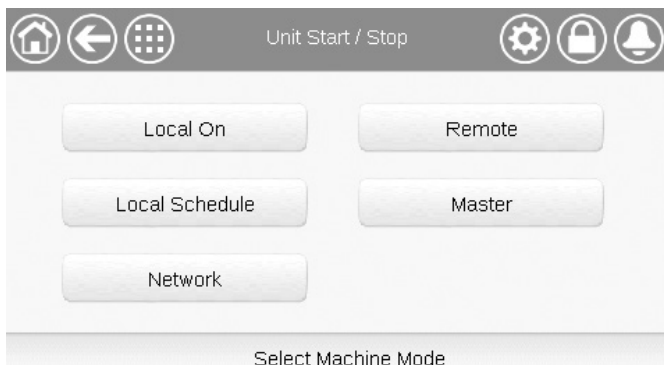

Local On	Local On: The unit is in the local control mode and allowed to start.
Local Schedule	Local Schedule: The unit is in the local control mode and allowed to start if the period is occupied.
Network	Network: The unit is controlled by network commands and allowed to start if the period is occupied.
Remote	Remote: The unit is controlled by external commands and allowed to start if the period is occupied.
Master	Master: The unit operates as the master in the master/slave assembly and allowed to start if the period is occupied. (Master button is displayed if Master/Slave Enable)

IMPORTANT:

When entering the menu, please note that the currently selected item corresponds to the last running operating mode.

This screen is displayed only when the unit is currently not running. If the unit was in the running state, then the Confirm stop message would be displayed.

To start the unit

1. Press the **Start/Stop** button.
2. Select the required Machine Mode.
3. The Welcome screen will be displayed.

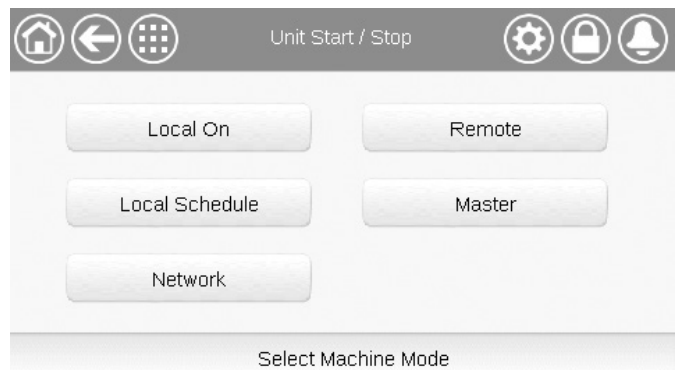

To stop the unit

1. Press the **Start/Stop** button.
2. Confirm the unit shutdown by pressing **Confirm Stop** or cancel the unit shutdown by pressing the **Back** button.



5 - CONNECT TOUCH USER INTERFACE

5.5 Set the schedule

The control incorporates two time schedules, where the first one (OCCPC01S) is used for controlling the unit start/stop, whereas the second one (OCCPC02S) is used for controlling the dual setpoint (Setpoint 1 used in Occupied mode / Setpoint 2 used in Unoccupied mode).

The control offers the user the possibility of setting eight occupancy periods where each occupancy period includes the following elements to be defined:

- Day of the week: Select the days when the period is occupied.
- Occupancy time ("occupied from" to "occupied to"): Set occupancy hours for the selected days.
- Timed Override Extension: Extend the schedule if necessary. This parameter can be used in the case of some unplanned events. Example: If the unit is normally scheduled to run between 8:00 to 18:00, but one day you want the air-conditioning system to operate longer, then set this timed override extension. If you set the parameter to "2", then the occupancy will end at 20:00.

NOTE: Time override extension is available only with the optional Energy Management Module.

To set the unit start/stop schedule

1. Go to the Main menu.
2. Navigate to the Configuration menu (logged-in users only) and select **Schedule Menu**  (SCHEDULE).
3. Go to **OCCPC01S**.
4. Select appropriate check boxes to set the unit occupancy on specific days.
5. Define the time of occupancy.
6. When the time schedule is set, the selected period will be presented in the form of the green band on the timeline.
7. Press the **Save** button to save your changes or the **Cancel** button to exit the screen without making modifications.

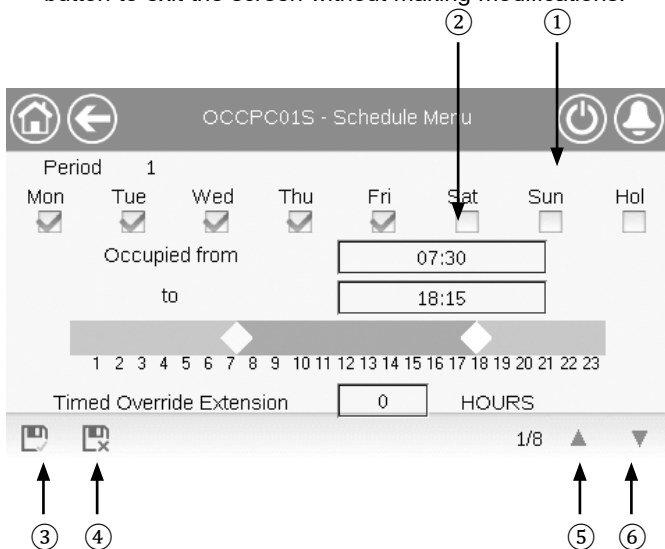

- ① Selection of days for the time schedule
- ② Start/end of the schedule
- ③ Save
- ④ Cancel
- ⑤ Previous time period
- ⑥ Next time period

IMPORTANT: Only logged-in users are allowed to access the Configuration menu.

Each program is in unoccupied mode unless a schedule time period is active.

If two periods overlap and are both active on the same day, **the occupied mode takes priority over the unoccupied period.**

Example: Schedule setting

Hour	MON	TUE	WED	THU	FRI	SAT	SUN	HOL
0:00	P1							
1:00	P1							
2:00	P1							
3:00								
4:00								
5:00								
6:00								
7:00	P2	P2	P3	P4	P4	P5		
8:00	P2	P2	P3	P4	P4	P5		
9:00	P2	P2	P3	P4	P4	P5		
10:00	P2	P2	P3	P4	P4	P5		
11:00	P2	P2	P3	P4	P4	P5		
12:00	P2	P2	P3	P4	P4			
13:00	P2	P2	P3	P4	P4			
14:00	P2	P2	P3	P4	P4			
15:00	P2	P2	P3	P4	P4			
16:00	P2	P2	P3	P4	P4			
17:00	P2	P2	P3					
18:00			P3					
19:00			P3					
20:00			P3					P6
21:00								
22:00								
23:00								

- MON: Monday
- TUE: Tuesday
- WED: Wednesday
- THU: Thursday
- FRI: Friday
- SAT: Saturday
- SUN: Sunday
- HOL: Holiday

Period / Schedule	Starts at	Stops at	Active on (days)
P1: Period 1	0:00	3:00	Monday
P2: Period 2	7:00	18:00	Monday + Tuesday
P3: Period 3	7:00	21:00	Wednesday
P4: Period 4	7:00	17:00	Thursday + Friday
P5: Period 5	7:00	12:00	Saturday
P6: Period 6	20:00	21:00	Holidays
P7: Period 7	Not used in this example		
P8: Period 8	Not used in this example		

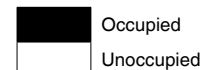

5 - CONNECT TOUCH USER INTERFACE

5.6 Manage display settings

The Language & Unit System screen allows the user to do any of the following:

- Select the language of the controller.
- Change the system of measurement (imperial or metric).

To access the User Login screen, press the **Login** button



in the upper-right corner of the Synoptic screen.

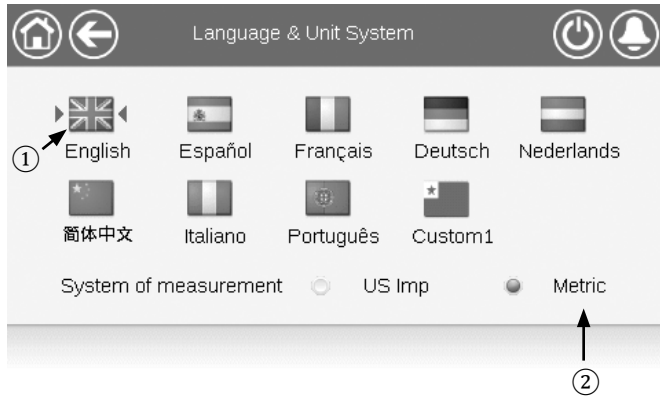

- ① Cursor indicating the selected language
- ② System of measurement: Metric/Imperial

NOTE: You may also leave the screen by pressing the **Back** button. Your changes will be saved.

The CONNECT TOUCH control system allows users to add new languages to the control. To learn more about language customization, please contact your local Manufacturer representative.

5.6.1 User login

Only logged-in users can access configurable unit parameters. By default, user password is "11".

To log in as user

1. Press the **Login** button to open User Login Screen.
2. Press the Password box.
3. A dialog box appears ("keyboard view"). Provide the password (11) and press **OK**.
4. The User Login screen appears.
5. Press the **Logged-in** button to save your changes or the **Logged-off** button to exit the screen without making modifications.

NOTE: You may also leave the screen by pressing the **Back** button.

Security access settings

- User-level security ensures that only authorised users are allowed to modify critical unit parameters.
- Only logged-in users are allowed to access the Configuration menu.
- It is strongly recommended to change the default password of the user interface to exclude the possibility of changing any parameters by an unqualified person.
- Only people qualified to manage the unit should be familiarized with the password.

5.6.2 User password

User password can be modified in the User Login menu.

To change your password

1. Press the **Login** button, and then select *User Login*.
2. Press the **Change User Password** button.
3. The **Change User Password** screen will be displayed.
4. Please provide the current password, and then type the new password twice.
5. Press the **Save** button to confirm password update or the **Cancel** button to exit the screen without making modifications.

5.6.3 Service & Factory Login

Service and factory login menus are dedicated to Service technicians and factory line. To learn more about advanced access control, please refer to the Control Service Guide (service technicians only).

5 - CONNECT TOUCH USER INTERFACE

5.7 Monitor unit parameters

The Main menu screen provides access to the main control parameters, including general parameters, inputs and outputs status, etc.

- To access the menu, press the **Main menu** button  located in the upper-left part of the Synoptic screen.
- Specific unit parameters can be accessed by pressing the icon corresponding to the desired category.
- To go back to the Synoptic screen, press the **Home** button.
- Press the **Up/Down** buttons to navigate between the screens.

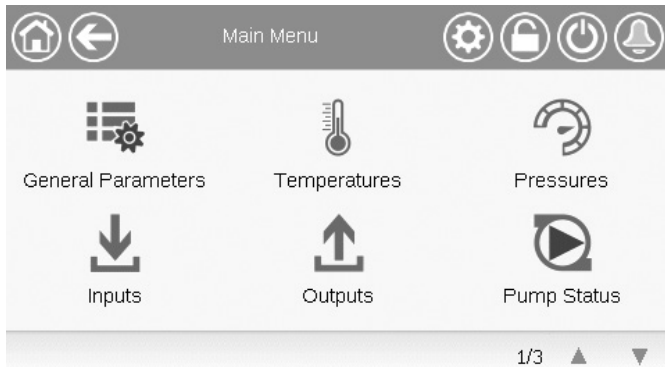

General unit parameters

The General parameters screen provides access to a set of general unit parameters.

- To access the General parameters screen, go to the Main menu and select **General Parameters**  (GENUNIT).
- Press the **Up/Down** buttons to navigate between the screens.

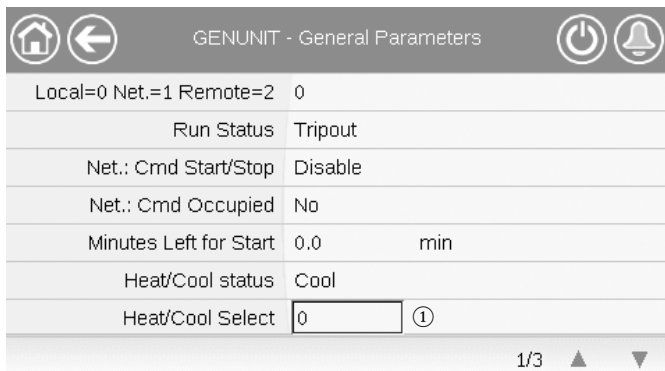

- ① Forceable point: In this example, it is used to change the unit mode – Cooling / Heating / Automatic changeover.

5.8 Modify unit parameters

The Configuration menu gives access to a number of user-modifiable parameters such as pump configuration, schedule menu, etc. The Configuration menu is password-protected.

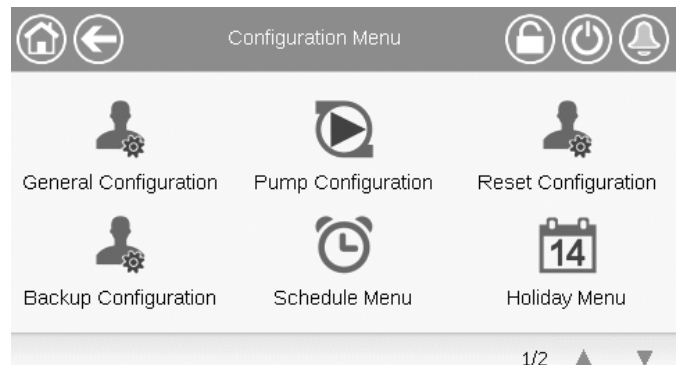

- To access the Configuration menu, press the **Main menu**  button located in the upper-left part of the Synoptic screen, and then find and press **Configuration Menu**.
- Press the field corresponding to the parameter to be modified and introduce all the necessary changes.
- Press the **Up/Down** buttons to navigate between the screens.
- Once all the necessary modifications have been made, press the **Save** button to save your changes or the **Cancel** button to exit the screen without making modifications.

5.9 Override system configuration

In some cases it is possible to override system configuration. The override screen provides the option to issue the command overriding the current operation of the unit.

To access the override screen, press the forceable point of the data screen. Note that not all parameters can be overridden by the control.

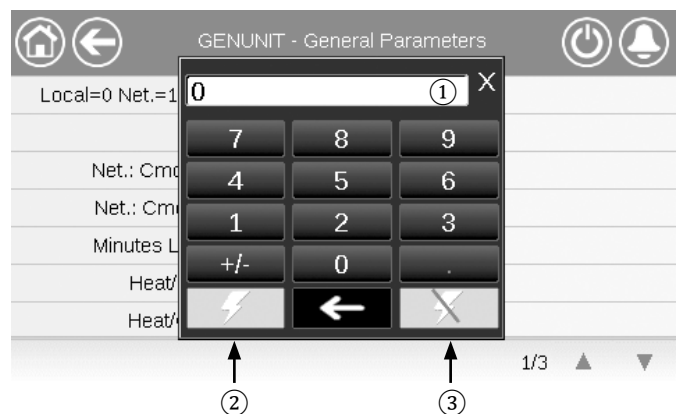

- ① Forced value
- ② Set force
- ③ Auto

5 - CONNECT TOUCH USER INTERFACE

5.10 Analyse history trends

The Trendings screen allows you to monitor a set of selected parameters.

- To access the Trendings screen, go to the Main menu and select **Trendings**  (TRENDING).
- Select the parameters to be displayed and press the **Save** button in the lower-left part of the screen.
 - A maximum of 4 trending points can be selected.
 - On Connect Touch 2.0: Swipe up or swipe down to display other trending points.

Example: Trendings (Connect Touch 2.0)

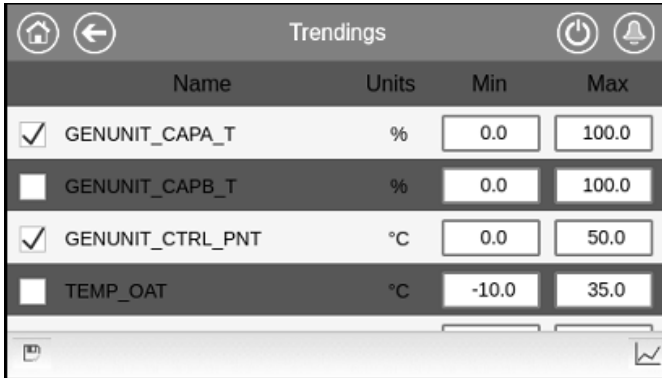



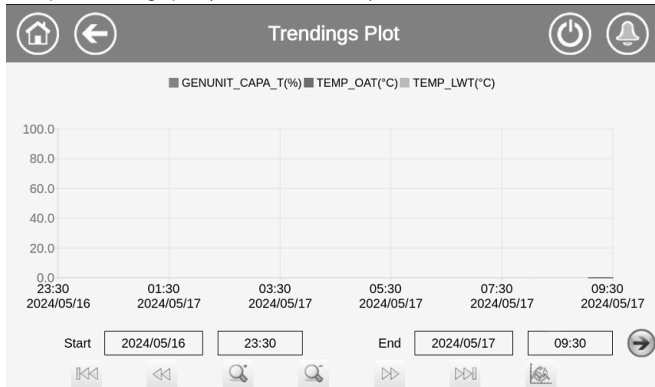

	Name	Units	Min	Max
<input checked="" type="checkbox"/>	GENUNIT_CAPA_T	%	0.0	100.0
<input type="checkbox"/>	GENUNIT_CAPB_T	%	0.0	100.0
<input checked="" type="checkbox"/>	GENUNIT_CTRL_PNT	°C	0.0	50.0
<input type="checkbox"/>	TEMP_OAT	°C	-10.0	35.0

- Press the **Trending**  to display the graph showing trends for the set of selected parameters.

Example: Trendings plot (Connect Touch 2.0)



- Press   to navigate across the timeline.
- Press the **Zoom in** button  to magnify the view or the **Zoom out** button  to expand the viewed area.
- Press the **Refresh** button () to reload data.

6 - WEB CONNECTION

6.1 Web interface

The CONNECT TOUCH control provides the functionality to access and control unit parameters from a web interface. To connect to the controller via the web interface, it is necessary to know the IP address of the unit.

To verify unit IP address:

1. Go to the System menu.
2. Select *Network* (NETWORK).
3. Verify TCP/IP Address for "IP Network Interface J5 (eth0)".
 - Unit default address:
169.254.1.1 (J5, eth0)
 - The unit IP address can be changed.

To access CONNECT TOUCH web interface:

1. Open the web browser.
2. Enter the IP address of the unit in the address bar of the web browser. Start with **https://** followed by the unit IP address.

Example: https://169.254.1.1

3. Press Enter.
4. The web interface will be loaded.

IMPORTANT: Three users can be connected simultaneously with no priority between them. The last modification is always taken into account.

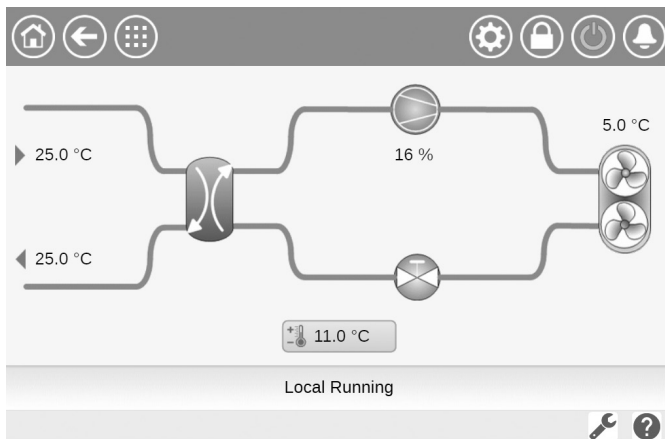

Minimum web browser configuration:

- Internet Explorer (version 11 or higher)
- Mozilla Firefox (version 60 or higher)
- Google Chrome (version 65 or higher) - recommended browser

For security reasons the unit cannot be started / stopped via the web interface. All other operations, including monitoring unit parameters or unit configuration, can be performed via the web browser interface.

Make sure that your network is protected from malicious attacks and any other security threats. Do not provide open access without proper network security safeguards. CIAT does not hold any responsibility or liability for damage caused by security breach.

6.2 Technical documentation

When using the CONNECT TOUCH control via a PC web browser, you may easily access all technical documents related to the product and its components.

Connect Touch web UI: Click the **Technical documentation** button  at the bottom of the page in order to see a list of documents related to the unit.

Connect Touch 2.0 web UI: Click "Technical Document"  in the navigation pane.

Technical documentation includes the following documents:

- Spare parts documentation: The list of spare parts included in the unit with reference, description and drafting.
- Misc: Documents such as electrical plans, dimension plans, unit certificates.
- PED: Pressure Equipment Directive.
- IOM: Installation operation and maintenance manual, controls installation/maintenance manual.

Connect Touch web UI: Click the **Help** button  to get access to BACnet user guide, Modbus user guide and Open Source Licenses used by Connect Touch.

Connect Touch 2.0 web UI: Click "Help"  in the navigation pane.

Document	Language	Type
FC101 - Danfoss Drive Troubleshooting	English	PDF
ATV212 - Schneider Drive Troubleshooting	English	PDF
BACnet User's guide	English	PDF
BACnet Guide utilisateur	French	PDF
ModBus User's guide	English	PDF
ModBus Guide utilisateur	French	PDF
Energy Meter	English	PDF
License information	English	PDF

IMPORTANT: Please save all data (documents, drawings, diagrams, etc.), for example, on your computer. If the display is replaced, all documents will be lost. Make sure that all documents are stored and may be accessed at any time.

6 - WEB CONNECTION

6.3 Connect Touch 2.0 web interface

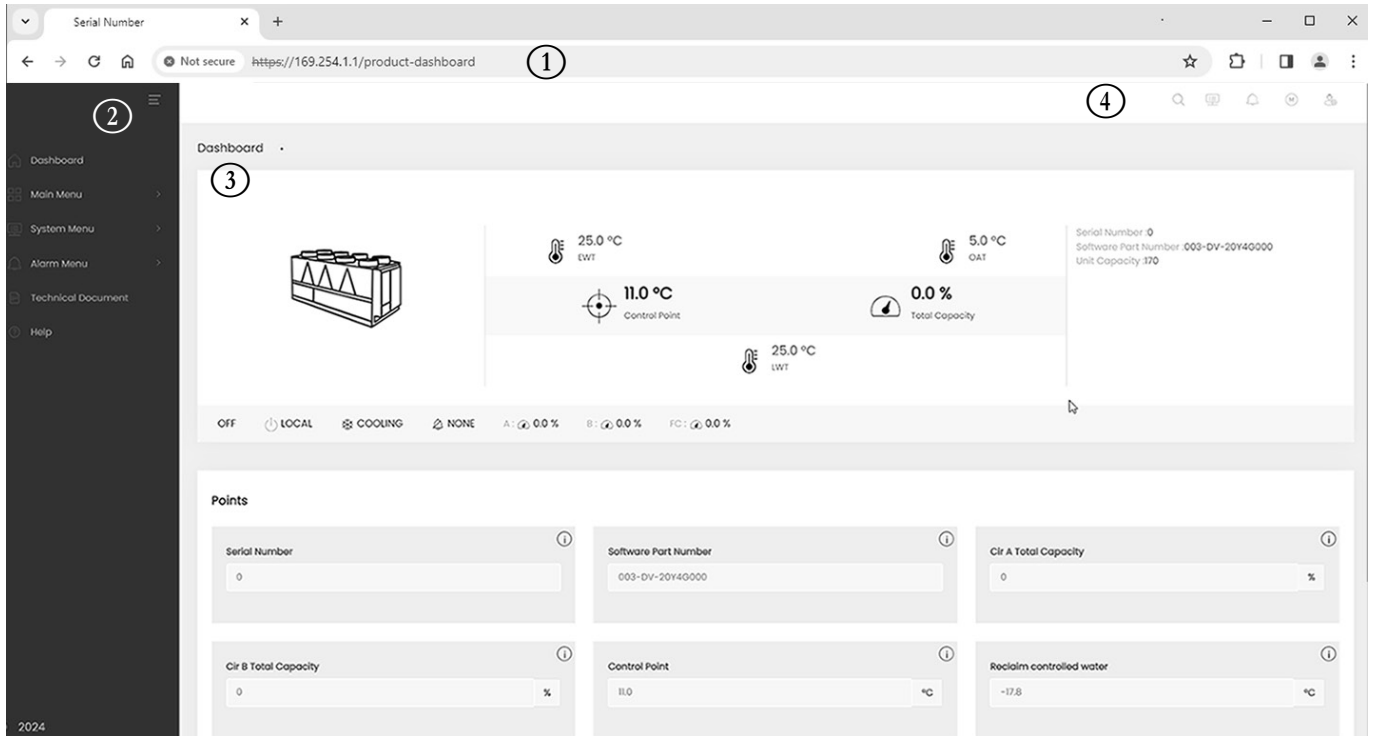

Web interface (home screen)

Web interface sections

- ① Address bar: Enter the IP address of the unit.
- ② The navigation pane on the left is used to switch between menus. Click/tap  to expand/collapse the Navigation pane.
- ③ Main application window: Used to display the content of the selected menu.

Click/tap the menu icon in the navigation pane:

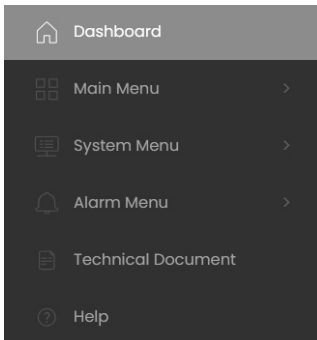

- ④ Quick access to Search, System menu, Alarm menu, Login and Start/Stop (read-only).

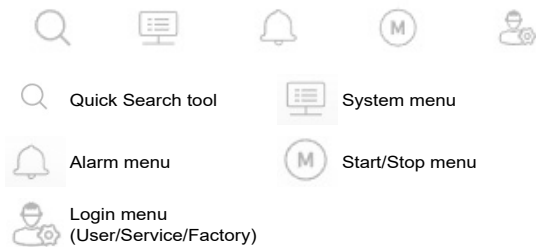

Dashboard

The Dashboard is the first view displayed when connecting to the web interface. It gives a clear and comprehensive view of the current operations of the chiller. This view is made up of several tiles that are snapshots of data presented in textual or graphical form.

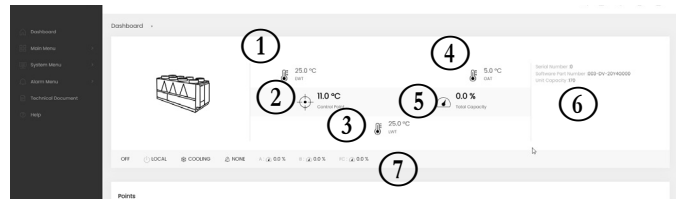



















- ① Cooler EWT (Entering Water Temperature)
- ② Control point
- ③ Cooler LWT (Leaving Water Temperature))
- ④ Outside air temperature
- ⑤ Total capacity
- ⑥ Additional information:
 - Serial number
 - Software version
 - Unit capacity
- ⑦ Status bar

- Unit status: OFF / RUNNING / STOPPING / DELAY / TRIP/OUT / READY / OVERRIDE / RUN TEST / TEST
- Mode: LOCAL / REMOTE / NETWORK
- Heat/Cool selection: COOLING / HEATING
- Alarm status: ALARM / NO ALARM
- A: Circuit A capacity
- B: Circuit B capacity
- FC: Free Cooling capacity

TIP: Hover over the image (or value) to see its description.

7 - CONNECT TOUCH CONTROL: MENU STRUCTURE

7.1 Main menu

Icon	Displayed text*	Description	Name
	General Parameters	General parameters	GENUNIT
	Temperatures	Temperatures	TEMP
	Pressures	Pressures	PRESSURE
	Inputs	Inputs status	INPUTS
	Outputs	Outputs status	OUTPUTS
	Pump Status	Pump status	PUMPSTAT
	Run Times	Run times	RUNTIME
	Modes	Modes status	MODES
	DC Free Cooling Status	DC Free Cooling Status	DCFC_STA
	Msc Status	Miscellaneous parameters status	MSC_STAT
	Heat Reclaim	Heat Reclaim	RECLAIM
	Hydraulic Free Cooling	Hydraulic Free Cooling	HYD_FC
	Trendings**	Trendings	TRENDING
	Setpoint Configuration	Setpoints configuration	SETPOINT
	Configuration Menu	Configuration menu (see section 7.2)	CONFIG
	Quick Test #1	Quick Test 1	QCK_TST1
	Energy Monitoring	Energy Monitoring	ENERGY
	Software Options	Software Options	OPT_STA

* Depends on the selected language (French by default).

** The Trendings menu is displayed in form of a graph; hence, it is not included in this section of the document (see section 5.10).

CAUTION

Since specific units may not include additional features, some tables may contain parameters that cannot be configured for a given unit.

7 - CONNECT TOUCH CONTROL: MENU STRUCTURE



General Parameters Menu – GENUNIT

Name	Status	Default	Unit	Displayed text*	Description
CTRL_TYP	0 to 2	0	-	Local=0 Net.=1 Remote=2	Operating mode: 0 = Local, 1 = Network, 2 = Remote
STATUS	-	-	-	Run Status	Unit running status: Off, Stopping, Delay, Running, Ready, Override, Tripout, Test, Runtest
CHIL_S_S	disable/enable	disable	-	Net.: Cmd Start/Stop	Unit start/stop via Network: When the unit is in Network mode, start/stop command can be forced
CHIL_OCC	no/yes	no	-	Net.: Cmd Occupied	Unit time schedule via Network: When the unit is in Network mode, the forced value can be used instead of the real occupancy state
min_left	-	-	min	Minutes Left for Start	Minutes before the unit start-up
HEATCOOL	Cool/Heat/ Standby/Both	-	-	Heat/Cool status	Heating/cooling status
HC_SEL	0 to 2	0	-	Heat/Cool Select	Heating/cooling selection
				0=Cool, 1=Heat, 2=Auto	0 = Cooling 1 = Heating 2 = Automatic heating/cooling control
SP_SEL	0 to 2	0	-	Setpoint Select	Setpoint selection
				0=Auto, 1=Spt1, 2=Spt2	0 = Automatic setpoint selection 1 = Setpoint 1 (active during occupied period) 2 = Setpoint 2 (active during unoccupied period)
SP_OCC	no/yes	yes	-	Setpoint Occupied?	Setpoint status: 0 = Unoccupied 1 = Occupied
CAP_T	-	-	%	Unit Total Capacity	Total unit capacity
CAPA_T	-	-	%	Cir A Total Capacity	Total capacity, circuit A
CAPB_T	-	-	%	Cir B Total Capacity	Total capacity, circuit B
SP	-	-	°C / °F	Current Setpoint	Current setpoint
CTRL_PNT	-	-	°C / °F	Control Point	Control point: Water temperature that the unit must produce
CTRL_WT	-	-	°C / °F	Control Water Temp	Controlled water temperature
OAT	-	-	°C / °F	Outdoor Air Temp	Outdoor air temperature
EMSTOP	disable/enable	disable	-	Emergency Stop	Emergency stop: Used to stop the unit regardless of its active operating type
DEM_LIM	0 to 100	0	%	Active Demand Limit Val	Active demand limit value: When the unit is in Network mode, the minimum value will be used compared to the status of the external limit switch contact and the demand limit switch setpoint
LAG_LIM	0 to 100	0	%	Lag Capacity Limit Value	Lag capacity limit value: Value that is forced by the master chiller (master/slave assembly)
DEMFLCLIM	0 to 100	100	%	Active FC Dem Lim Val	Active Free Cooling demand limit value
LAGFLCLIM	0 to 100	0	%	Lag FC Cap Limit Value	Lag Free Cooling capacity limit value (FC capacity limit applicable to the lag unit in the master/slave assembly)
SGR_st	1 to 4	2	-	Smart Grid Ready Status	Smart Grid Ready status (operating mode): 1 = LOCK 2 = NORMAL 3 = BOOST 4 = FORCED

* Depends on the selected language (French by default).



Temperatures Menu – TEMP

Name	Status	Default	Unit	Displayed text*	Description
EWT	-	-	°C / °F	Entering Fluid Temp	Evaporator entering water temperature: Used for capacity control
LWT	-	-	°C / °F	Leaving Fluid Temp	Evaporator leaving water temperature: Used for capacity control
OAT	-	-	°C / °F	Outdoor Air Temp	Outdoor air temperature: Used to determine a number of control mechanisms such as heat/cool changeover, heater operation, defrost cycle, and more
SCT_A	-	-	°C / °F	Saturated Cond Tmp cir A	Saturated condensing temperature, circuit A
SST_A	-	-	°C / °F	Saturated Suction Temp A	Saturated suction temperature, circuit A
SUCT_A	-	-	°C / °F	Compressor Suction Tmp A	Compressor suction temperature, circuit A
SH_A	-	-	°C / °F	Suction Superheat Tmp A	Suction superheat temperature, circuit A
DGT_A	-	-	°C / °F	Discharge Gas Temp A	Discharge gas temperature, circuit A
DGTM_A	-	-	°C / °F	Mean Disc. Gas Temp A	Average discharge gas temperature, circuit A
DEFRT_A	-	-	°C / °F	Defrost Temperature A	Defrost temperature, circuit A (heat pumps)
SCT_B	-	-	°C / °F	Saturated Cond Tmp cir B	Saturated condensing temperature, circuit B
SST_B	-	-	°C / °F	Saturated Suction Temp B	Saturated suction temperature, circuit B

7 - CONNECT TOUCH CONTROL: MENU STRUCTURE



Temperatures Menu – TEMP (continued)

Name	Status	Default	Unit	Displayed text*	Description
SUCT_B	-	-	°C / °F	Compressor Suction Tmp B	Compressor suction temperature, circuit B
SH_B	-	-	°C / °F	Suction Superheat Tmp B	Suction superheat temperature, circuit B
DGT_B	-	-	°C / °F	Discharge Gas Temp B	Discharge gas temperature, circuit B
DGTM_B	-	-	°C / °F	Mean Disc. Gas Temp B	Average discharge gas temperature, circuit B
DEFRT_B	-	-	°C / °F	Defrost Temperature B	Defrost temperature, circuit B (heat pumps)
SPACETMP	-	-	°C / °F	Optional Space Temp	Space (room) temperature: Applies to units with the optional Energy Management Module
CHWSTEMP	-	-	°C / °F	Cold Water System Temp	Cold water system temperature
HRctrWat	-	-	°C / °F	Reclaim controlled water	Heat Reclaim control water temperature
HR_LWT	-	-	°C / °F	HR Leaving Fluid temp	Heat Reclaim leaving fluid temperature
FC_EV_WT	-	-	°C / °F	FC Evap Water Temp	Free Cooling evaporator water temperature (option 305A / 305B / 305C): The sensor is located at the inlet of the evaporator
FC_WGT	-	-	°C / °F	FC Glycol Water Temp	Free Cooling glycol-water solution temperature (option 305C): This temperature sensor is located at the input of the Glycol-Free BPHE (in the glycol-water loop)

* Depends on the selected language (French by default).



Pressures Menu – PRESSURE

Name	Status	Default	Unit	Displayed text*	Description
DP_A	-	-	kPa / PSI	Discharge Pressure A	Compressor discharge pressure, circuit A
SP_A	-	-	kPa / PSI	Main Suction Pressure A	Compressor suction pressure, circuit A
DP_B	-	-	kPa / PSI	Discharge Pressure B	Compressor discharge pressure, circuit B
SP_B	-	-	kPa / PSI	Main Suction Pressure B	Compressor suction pressure, circuit B
PUMP_EWP	-	-	kPa / PSI	Inlet unit water pres.	Pump entering water pressure
PUMP_LWP	-	-	kPa / PSI	Outlet unit water pres.	Pump leaving water pressure
fc_ewp	-	-	kPa / PSI	FC pmp inlet water pres	Free cooling pump inlet water pressure (option 305C)
fc_lwp	-	-	kPa / PSI	FC pmp outlet water pres	Free cooling pump outlet water pressure (option 305C)

* Depends on the selected language (French by default).



Inputs Menu – INPUTS

Point name	Status	Default	Unit	Displayed text*	Description
ONOFF_SW	open/close	open	-	Remote On/Off Switch	Remote on/off switch
HC_SW	open/close	open	-	Remote HeatCool Switch	Remote heating/cooling selection switch
SETP_SW	open/close	open	-	Remote Setpoint Switch	Remote setpoint selection switch
LIM_SW1	open/close	open	-	Limit Switch 1	Demand limit switch 1
LIM_SW2	open/close	open	-	Limit Switch 2	Demand limit switch 2 (Energy Management Module)
LOCK_SW	open/close	open	-	Customer Interlock	Customer interlock: When the contact is closed, the unit will be stopped with no delay. The switch is provided on the customer's terminal block of the optional Energy Management Module
FLOW_SW	open/close	open	-	Flow Switch Status	Flow switch status
DSHTR_SW	open/close	open	-	Desuper heater demand	Desuperheater status
REM_LOCK	open/close	open	-	Remote Interlock Status	Remote interlock status
OCC_OVSW	open/close	open	-	Occupied Override Switch	Occupied override switch
ICE_SW	open/close	open	-	Ice Done Storage Switch	Ice done storage switch
ELEC_BOX	open/close	open	-	Electrical Box Failure	Electrical box failure
cp_a1_f	open/close	open	-	Compressor A1 failure	Compressor A1 failure
cp_a2_f	open/close	open	-	Compressor A2 failure	Compressor A2 failure
cp_a3_f	open/close	open	-	Compressor A3 failure	Compressor A3 failure
cp_a4_f	open/close	open	-	Compressor A4 failure	Compressor A4 failure
HP_SW_A	open/close	open	-	High Pressure Switch A	High pressure switch, circuit A
cp_b1_f	open/close	open	-	Compressor B1 failure	Compressor B1 failure
cp_b2_f	open/close	open	-	Compressor B2 failure	Compressor B2 failure
cp_b3_f	open/close	open	-	Compressor B3 failure	Compressor B3 failure
cp_b4_f	open/close	open	-	Compressor B4 failure	Compressor B4 failure
HP_SW_B	open/close	open	-	High Pressure Switch B	High pressure switch, circuit B
leak_v1	-	-	V	Leakage Detection 1	Leakage detection 1
leak_v2	-	-	V	Leakage Detection 2	Leakage detection 2

7 - CONNECT TOUCH CONTROL: MENU STRUCTURE



Inputs Menu – INPUTS (continued)

Point name	Status	Default	Unit	Displayed text*	Description
SP_RESET	4 to 20	4.0	mA	Setpoint Reset Signal	Setpoint reset signal
LIM_4_20	4 to 20	4.0	mA	Capacity Limit Control	Capacity limit control
RECL_SW	open/close	open	-	Remote Reclaim switch	Heat Reclaim remote switch in Remote mode: open = Heat Reclaim mode disabled closed = Heat Reclaim mode enabled
fc_ev_ci	no/yes	no	-	Is FC Evap Valve Closed?	Is Free Cooling evaporator valve closed?
fc_ev_oi	no/yes	no	-	Is FC Evap Valve Opened?	Is Free Cooling evaporator valve open?
fc_cv_ci	no/yes	no	-	Is FC Coil Valve Closed?	Is Free Cooling coil valve closed?
fc_cv_oi	no/yes	no	-	Is FC Coil Valve Opened?	Is Free Cooling coil valve open?
PH_CTRL	open/close	open	-	Phase Controller	Phase controller input (option 159B) Note: This option is compatible only with units fitted with CIOB board.
PMP_QM	open/close	open	-	Pump Quicktest QM	Pump quick test
SGR0_BST	open/close	open	-	SG Ready #0 (Boost)	Smart Grid Ready control input (Boost)
SGR1_LCK	open/close	open	-	SG Ready #1 (Lock)	Smart Grid Ready control input (Lock)

* Depends on the selected language (French by default).



Outputs Menu – OUTPUTS

Point name	Status	Default	Unit	Displayed text*	Description
CP_A1	off/on	off	-	Compressor A1	Compressor A1 command
CP_A2	off/on	off	-	Compressor A2	Compressor A2 command
CP_A3	off/on	off	-	Compressor A3	Compressor A3 command
CP_A4	off/on	off	-	Compressor A4	Compressor A4 command
FAN_A1	off/on	off	-	Fan A1	Fan A1 status
FAN_A2	off/on	off	-	Fan A2	Fan A2 status
FAN_A3	off/on	off	-	Fan A3	Fan A3 status
FAN_A4	off/on	off	-	Fan A4	Fan A4 status
FAN_A5	off/on	off	-	Fan A5	Fan A5 status
FAN_A6	off/on	off	-	Fan A6	Fan A6 status
FAN_ST_A	0 to 10	0	-	Fan Staging Number Cir A	Current fan stage of circuit A
VFAN_A	-	-	%	Variable fan A command	Variable fan A command
EXV_A	0 to 100	0	%	EXV position Circuit A	EXV position, circuit A
RV_A	off/on	off	-	4-way Refrig. Valve A	4-way refrigerant valve, circuit A: Used to manage cooling / heating / defrost operation (heat pumps)
HD_HTR_A	off/on	off	-	Compressor Head Heater A	Compressor head heater, circuit A (only units with variable speed fans controlled through the internal bus)
CO_HTR_A	off/on	off	-	Coil Heater A	Coil Heater A, circuit A
HGBP_V_A	off/on	off	-	Hot Gas Bypass Valve A	Note: This is not applicable to units located in EMEA
CP_B1	off/on	off	-	Compressor B1	Compressor B1 command
CP_B2	off/on	off	-	Compressor B2	Compressor B2 command
CP_B3	off/on	off	-	Compressor B3	Compressor B3 command
CP_B4	off/on	off	-	Compressor B4	Compressor B4 command
FAN_B1	off/on	off	-	Fan B1	Fan B1 status
FAN_B2	off/on	off	-	Fan B2	Fan B2 status
FAN_B3	off/on	off	-	Fan B3	Fan B3 status
FAN_B4	off/on	off	-	Fan B4	Fan B4 status
FAN_B5	off/on	off	-	Fan B5	Fan B5 status
FAN_B6	off/on	off	-	Fan B6	Fan B6 status
FAN_ST_B	0 to 10	0	-	Fan Staging Number Cir B	Current fan stage of circuit B
VFAN_B	-	-	%	Variable fan B command	Variable fan B command
EXV_B	0 to 100	0	%	EXV position Circuit B	EXV position, circuit B
RV_B	off/on	off	-	4-way Refrig. Valve B	4-way refrigerant valve, circuit B: Used to manage cooling / heating / defrost operation (heat pumps)
HD_HTR_B	off/on	off	-	Compressor Head Heater B	Compressor head heater, circuit B (only units with variable speed fans controlled through the internal bus)
CO_HTR_B	off/on	off	-	Coil Heater B	Coil Heater B, circuit B
RUNNING	off/on	off	-	Running Relay Status	Running relay status
ALARM	off/on	off	-	Alarm Relay Status	Alarm relay status
ALERT	off/on	off	-	Alert Relay State	Alert relay status

7 - CONNECT TOUCH CONTROL: MENU STRUCTURE



Outputs Menu – OUTPUTS (continued)

Point name	Status	Default	Unit	Displayed text*	Description
SHUTDOWN	off/on	off	-	Shutdown Indicator State	Shutdown indicator state
EXCH_HTR	off/on	off	-	Exchanger Heater	Water exchanger heater
SET_FLOW	off/on	off	-	Flow Switch Setpoint cfg	Flow switch setpoint configuration
CAPT_010	-	-	V	Chiller Capacity Running	Chiller capacity running
BOILER	off/on	off	-	Boiler Output	Boiler output
EHS1	off/on	off	-	Electrical Heat Stage 1	Electrical heat stage 1
EHS2	off/on	off	-	Electrical Heat Stage 2	Electrical heat stage 2
EHS3	off/on	off	-	Electrical Heat Stage 3	Electrical heat stage 3
EHS4	off/on	off	-	Electrical Heat Stage 4	Electrical heat stage 4
DSH_PUMP	off/on	off	-	Desuperheater Pump	Desuperheater pump
fc_ev_cc	off/on	off	-	FC Evap Valve Close Cmd	Free Cooling evaporator valve, closing command (option 305A/305B)
fc_ev_oc	off/on	off	-	FC Evap Valve Open Cmd	Free Cooling evaporator valve, opening command (option 305A/305B)
fc_cv_cc	off/on	off	-	FC Coil Valve Close Cmd	Free Cooling coil valve, closing command (option 305A/305B)
fc_cv_oc	off/on	off	-	FC Coil Valve Open Cmd	Free Cooling coil valve, opening command (option 305A/305B)
fc_pump	off/on	off	-	FC Coil Pump Cmd	Free Cooling pump command (option 305C)
fc_htr	off/on	off	-	FC Heater Cmd	Free Cooling heater command (option 305C)

* Depends on the selected language (French by default).



Pump Status Menu – PUMPSTAT

Name	Status	Default	Unit	Displayed text*	Description
ROTWPUMP	no/yes	no	-	Rotate Water Pumps Now?	Water pumps rotation
PUMP_1	off/on	off	-	Water Pump #1 Command	Water pump 1 control
PUMP_2	off/on	off	-	Water Pump #2 Command	Water pump 2 control
wp_out	-	-	kPa / PSI	Outlet Water Pres.(cor)	Outlet water pressure (corrected by temperature) Applies to units with the hydronic kit option
wp_in	-	-	kPa / PSI	Inlet Water Pres.(cor)	Inlet water pressure (corrected by temperature) Applies to units with the hydronic kit option
WP_CAL	no/yes	no	-	Water Pres. Calibration?	Water pressure calibration
wp_off	-	-	kPa / PSI	Water Pressure Offset	Water pressure offset
wp_filt	-	-	kPa / PSI	Delta Pressure Filter	Delta pressure filter
wp_min	-	-	kPa / PSI	Minimum Water Pressure	Minimum water pressure
flow	-	-	l/s / GPS	Water Flow	Water flow rate
dt_stp	-	-	°C / °F	Water Delta T Setpoint	Water delta temperature setpoint
delta_t	-	-	°C / °F	Current Water Delta T	Current water delta temperature
dp_stp	-	-	kPa / PSI	Water Delta P Setpoint	Water delta pressure setpoint
delta_p	-	-	kPa / PSI	Current Water Delta P	Current water delta pressure
MxDeltaP	-	-	kPa / PSI	Cur. Max Water Delta P	Maximum current water delta pressure
VPMP_CMD	0 to 100	0	%	Variable Speed Pump Cmd	Variable speed pump cmd

* Depends on the selected language (French by default)



Run Times Menu – RUNTIME

Name	Status	Default	Unit	Displayed text*	Description
hr_mach	-	-	hour	Machine Operating Hours	Unit operating hours
st_mach	-	-	-	Machine Starts Number	Number of unit starts
hr_cp_a1	-	-	hour	Compressor A1 Hours	Operating hours, compressor A1
hr_cp_a2	-	-	hour	Compressor A2 Hours	Operating hours, compressor A2
hr_cp_a3	-	-	hour	Compressor A3 Hours	Operating hours, compressor A3
hr_cp_a4	-	-	hour	Compressor A4 Hours	Operating hours, compressor A4
hr_cp_b1	-	-	hour	Compressor B1 Hours	Operating hours, compressor B1
hr_cp_b2	-	-	hour	Compressor B2 Hours	Operating hours, compressor B2
hr_cp_b3	-	-	hour	Compressor B3 Hours	Operating hours, compressor B3
hr_cp_b4	-	-	hour	Compressor B4 Hours	Operating hours, compressor B4
st_cp_a1	-	-	-	Compressor A1 Starts	Number of starts, compressor A1
st_cp_a2	-	-	-	Compressor A2 Starts	Number of starts, compressor A2
st_cp_a3	-	-	-	Compressor A3 Starts	Number of starts, compressor A3
st_cp_a4	-	-	-	Compressor A4 Starts	Number of starts, compressor A4

7 - CONNECT TOUCH CONTROL: MENU STRUCTURE



Run Times Menu – RUNTIME (continued)

Name	Status	Default	Unit	Displayed text*	Description
st_cp_b1	-	-	-	Compressor B1 Starts	Number of starts, compressor B1
st_cp_b2	-	-	-	Compressor B2 Starts	Number of starts, compressor B2
st_cp_b3	-	-	-	Compressor B3 Starts	Number of starts, compressor B3
st_cp_b4	-	-	-	Compressor B4 Starts	Number of starts, compressor B4
hr_fana1	-	-	hour	Fan A1 Hours	Operating hours, fan A1
hr_fana2	-	-	hour	Fan A2 Hours	Operating hours, fan A2
hr_fana3	-	-	hour	Fan A3 Hours	Operating hours, fan A3
hr_fana4	-	-	hour	Fan A4 Hours	Operating hours, fan A4
hr_fana5	-	-	hour	Fan A5 Hours	Operating hours, fan A5
hr_fana6	-	-	hour	Fan A6 Hours	Operating hours, fan A6
hr_fana7	-	-	hour	Fan A7 Hours	Operating hours, fan A7
hr_fana8	-	-	hour	Fan A8 Hours	Operating hours, fan A8
hr_fanb1	-	-	hour	Fan B1 Hours	Operating hours, fan B1
hr_fanb2	-	-	hour	Fan B2 Hours	Operating hours, fan B2
hr_fanb3	-	-	hour	Fan B3 Hours	Operating hours, fan B3
hr_fanb4	-	-	hour	Fan B4 Hours	Operating hours, fan B4
hr_fanb5	-	-	hour	Fan B5 Hours	Operating hours, fan B5
hr_fanb6	-	-	hour	Fan B6 Hours	Operating hours, fan B6
hr_fanb7	-	-	hour	Fan B7 Hours	Operating hours, fan B7
hr_fanb8	-	-	hour	Fan B8 Hours	Operating hours, fan B8
hr_pump1	-	-	hour	Water Pump #1 Hours	Operating hours, water pump 1
hr_pump2	-	-	hour	Water Pump #2 Hours	Operating hours, water pump 2
nb_defra	-	-	-	Circuit A Defrost Number	Defrost session number, circuit A
nb_defrb	-	-	-	Circuit B Defrost Number	Defrost session number, circuit B
hr_fcPmp	-	-	hour	Free Cooling Pump Hours	Operating hours, free cooling pump

* Depends on the selected language (French by default).

M Modes Menu – MODES

Name	Status	Default	Unit	Displayed text*	Description
m_delay	no/yes	no	-	Start Up Delay In Effect	Start-up delay in effect
m_2stpt	no/yes	no	-	Second Setpoint In Use	Second setpoint in use: The setpoint used during unoccupied periods
m_reset	no/yes	no	-	Reset In Effect	Setpoint reset active
m_demlim	no/yes	no	-	Demand limit active	Demand limit active
m_rpload	no/yes	no	-	Ramp Loading Active	Ramp loading active
m_whtr	no/yes	no	-	Water Exchanger Heater	Water exchanger heater active
m_pmprot	no/yes	no	-	Water Pump Rotation	Water pump rotation
m_pmpper	no/yes	no	-	Pump Periodic Start	Pump periodic start
m_lowscA	no/yes	no	-	Low Suction Circuit A	Low suction, circuit A
m_lowscB	no/yes	no	-	Low Suction Circuit B	Low suction, circuit B
m_hidgta	no/yes	no	-	High DGT Circuit A	High DGT, circuit A
m_hidgtb	no/yes	no	-	High DGT Circuit B	High DGT, circuit B
m_hiprsa	no/yes	no	-	High Press Override CirA	High pressure override, circuit A
m_hiprsb	no/yes	no	-	High Press Override CirB	High pressure override, circuit B
m_dltP_a	no/yes	no	-	Low Delta Press Cir A	Low delta pressure, circuit A
m_dltP_b	no/yes	no	-	Low Delta Press Cir B	Low delta pressure, circuit B
m_night	no/yes	no	-	Night Low Noise Active	Night low noise active
m_hsm	no/yes	no	-	System Manager Active	System Manager active
m_slave	no/yes	no	-	Master Slave Active	Master/slave mode active
m_autoch	no/yes	no	-	Auto Changeover Active	Automatic changeover active
m_defr_a	no/yes	no	-	Defrost Active Circuit A	Defrost mode active, circuit A (heat pumps)
m_defr_b	no/yes	no	-	Defrost Active Circuit B	Defrost mode active, circuit B (heat pumps)
m_boiler	no/yes	no	-	Boiler Active	Boiler active
m_ehs	no/yes	no	-	Electric Heater Active	Electric heater active
m_ewtlck	no/yes	no	-	Heating Low EWT Lockout	Heating low EWT lockout
m_ice	no/yes	no	-	Ice Mode In Effect	Ice mode active
m_fastRe	no/yes	no	-	Fast Capacity Recovery	Fast capacity recovery mode in progress

* Depends on the selected language (French by default).

7 - CONNECT TOUCH CONTROL: MENU STRUCTURE



DC Free Cooling Status Menu – DCFC_STA

Name	Status	Default	Unit	Displayed text*	Description
oat	-	-	°C / °F	OAT Free Cooling	Dry Cooler Free Cooling: OAT
lwt	-	-	°C / °F	FC Leaving Water Temp	Dry Cooler Free Cooling: Leaving water temperature
wloop	-	-	°C / °F	FC Water Loop Temp	Dry Cooler Free Cooling: Water loop temperature
m_dcfc	no/yes	no	-	Free Cooling Mode Active	Dry Cooler Free Cooling mode active
dcfc_cap	0 to 100	0	%	FC Capacity	Dry Cooler Free Cooling capacity
f_stage	0 to 20	0	-	Fix Speed Fans Stage	Dry Cooler Free Cooling: Fan stage (fixed speed fans)
vf_speed	0 to 100	0	%	Varifan Speed	Dry Cooler Free Cooling: Fan speed (variable speed)
pid_out	0 to 100	-	%	PID Output	Status of PID output
FC_HOUR	0 to 999999	-	hour	DCFC Operating Hours	Dry Cooler Free Cooling: Operating hours
FC_FAN1S	0 to 999999	-	-	DCFC Fan Stage 1 Start	DCFC / Fan stage 1: Number of starts
FC_FAN1H	0 to 999999	-	hour	DCFC Fan Stage 1 Hours	DCFC / Fan stage 1: Operating hours
FC_FAN2S	0 to 999999	-	-	DCFC Fan Stage 2 Start	DCFC / Fan stage 2: Number of starts
FC_FAN2H	0 to 999999	-	hour	DCFC Fan Stage 2 Hours	DCFC / Fan stage 2: Operating hours
FC_FAN3S	0 to 999999	-	-	DCFC Fan Stage 3 Start	DCFC / Fan stage 3: Number of starts
FC_FAN3H	0 to 999999	-	hour	DCFC Fan Stage 3 Hours	DCFC / Fan stage 3: Operating hours
FC_FAN4S	0 to 999999	-	-	DCFC Fan Stage 4 Start	DCFC / Fan stage 4: Number of starts
FC_FAN4H	0 to 999999	-	hour	DCFC Fan Stage 4 Hours	DCFC / Fan stage 4: Operating hours
FC_FAN5S	0 to 999999	-	-	DCFC Fan Stage 5 Start	DCFC / Fan stage 5: Number of starts
FC_FAN5H	0 to 999999	-	hour	DCFC Fan Stage 5 Hours	DCFC / Fan stage 5: Operating hours
FC_FAN6S	0 to 999999	-	-	DCFC Fan Stage 6 Start	DCFC / Fan stage 6: Number of starts
FC_FAN6H	0 to 999999	-	hour	DCFC Fan Stage 6 Hours	DCFC / Fan stage 6: Operating hours
FC_FAN7S	0 to 999999	-	-	DCFC Fan Stage 7 Start	DCFC / Fan stage 7: Number of starts
FC_FAN7H	0 to 999999	-	hour	DCFC Fan Stage 7 Hours	DCFC / Fan stage 7: Operating hours
FC_VFANS	0 to 999999	-	-	DCFC Variable Fan Start	DCFC / Variable speed fan: Number of starts
FC_VFANH	0 to 999999	-	hour	DCFC Variable Fan Hours	DCFC / Variable speed fan: Operating hours

* Depends on the selected language (French by default).



Msc Status Menu – MSC_STAT

Name	Status	Default	Unit	Displayed text*	Description
m_ecopmp	no/yes	no	-	Eco Pump Mode Active	Eco pump mode status: When this mode is active, the pump is stopped periodically when the unit is in Standby

* Depends on the selected language (French by default).



Heat Reclaim Menu – RECLAIM

Name	Status	Default	Unit	Displayed text*	Description
RECL_SEL	no/yes	no	-	Reclaim Selection	Enable/Disable Heat Reclaim
HR_stat	0 to 10	0	-	Reclaim Status	Heat Reclaim status: 0 = Heat Reclaim mode is "off" 1 = Heat Reclaim mode is "on" 2 = Compressor must be running for 2 minutes before the Heat Reclaim mode is started 3 = Heat Reclaim mode is ending 4 = Minimum flow rate is set on 5 = Condenser freeze protection (alarm 10128) 6 = 3-way valve controlled based on PID in order to prevent boiling water conditions 7 = 3-way valve is in Standby mode 10 = 3-way valve position is forced
HRCtrPnt	-	-	°C / °F	Reclaim control point	Heat Reclaim control point
HRCtrWat	-	-	°C / °F	Reclaim controlled water	Heat Reclaim control water temperature
HR_LWT	-	-	°C / °F	HR Leaving Fluid temp	Heat Reclaim leaving water temperature
HR_FLOW	close/open	close	-	Heat Reclaim Flow switch	Heat Reclaim flow switch is used to check if the water is running inside the HR condenser
cmd_3WV	0 to 100	0	%	3WayValve / VarPump cmd	Heat Reclaim 3-way valve / pump command (100% = fully open) open = there is water flow in the condenser and in the customer loop closed = water flow depends on "Min flow 3wv position" defined in the HR_CFG table

7 - CONNECT TOUCH CONTROL: MENU STRUCTURE



Heat Reclaim Menu – RECLAIM

Name	Status	Default	Unit	Displayed text*	Description
out_3WV	0 to 10	0	V	3WayValve / VarPump outp	Heat Reclaim 3-way valve / pump output (0-10V): 0V = valve is closed (standard setting) Note: It is also possible to set the reversed valve signal (see also "HR reverse 3WV cmd ?" in the HR_CFG table).
mode_3WV	0 to 1	0	-	3WayValve / VarPump mode	Heat Reclaim 3-way valve / pump mode
				0: Low HR LWT control	0 = valve/pump control in low HR_LWT mode (HR_LWT < 35°C)
				1: HR water temp control	1 = valve/pump control in normal HR_LWT mode
actiMode	0 to 1	1	-	HR active mode (3WV/Fan)	Heat Reclaim (3-way valve / fans)
				0 : 3-way valve mode	0 = 3-way valve is controlling the HR water temperature (fans are running to improve unit efficiency)
				1 : Fan mode	1 = 3-way valve is fully opened (fans are controlling the HR water temperature)
HR_pump	off/on	off	-	Reclaim pump command	Heat Reclaim pump command (the on/off pump on the customer side when a 3-way valve is mounted)
HRheater	off/on	off	-	Reclaim BPHE Heater	BPHE heater (optional): Please note that the heater is available only for HR units running on water. The controller monitors the water temperature to activate the optional heater when necessary.

* Depends on the selected language (French by default).



Hydraulic Free Cooling Menu – HYD_FC

Name	Status	Default	Unit	Displayed text*	Description
FC_DSBLE	no/yes	no	-	Free Cooling Disable?	Enable/disable Free Cooling (FC): yes = Free Cooling disabled no = Free Cooling enabled
fcCapT	-	-	%	Total FC Capacity	Total Free Cooling capacity (circuit A + circuit B)
wLoopPst	Mecha Cooling / Mixed/Free Cooling	-	-	Water Loop Position	Water loop position: "Mecha Cooling" = when the loop is in normal position (mechanical cooling) "Mixed/Free Cooling" = when the loop is in Mixed/Free Cooling position (the water is passing through FC coils)
fc_ovr	0 to 10	-	-	FC Override	Free Cooling overrides: 0 = FC not configured 1 = FC disabled (unit is OFF) 2 = FC disabled (too high OAT) 3 = FC disabled (FC point forced) 5 = FC disabled (switching between mechanical cooling and free cooling) 6 = FC disabled (unit in alarm) 7 = FC disabled (LAGFLIM in GENUIT is set to 0%) 8 = FC activated 9 = FC disabled (BPHE freeze protection mode) 10 = FC disabled (pump alarm)
fcCapA	-	-	%	FC Capacity A	Free Cooling capacity, circuit A
modeCirA	0 to 3	0	-	Mode of Circuit A	Free Cooling mode, circuit A: 0 = Mechanical Cooling (MC) only 1 = Mixed Cooling (MC and FC at the same time) 2 = Controlled Free Cooling capacity (fan speed control based on water temperature) 3 = Full power Free cooling state (fan at maximum speed)
mcCurPwA	-	-	kW	MC Current Power A	Mechanical cooling current power, circuit A
fcCurPwA	-	-	kW	FC Current Power A	Free Cooling current power, circuit A
fcMaxPwA	-	-	kW	FC Max Power A	Free Cooling maximum power, circuit A
fcCapB	-	-	%	FC Capacity B	Free Cooling capacity, circuit B
modeCirB	0 to 3	0	-	Mode of circuit B	Free Cooling mode, circuit B: 0 = Mechanical Cooling (MC) only 1 = Mixed Cooling (MC and FC at the same time) 2 = Controlled Free Cooling capacity (fan speed control based on water temperature) 3 = Full power Free cooling state (fan at maximum speed)
mcCurPwB	-	-	kW	MC Current Power B	Mechanical cooling current power, circuit B
fcCurPwB	-	-	kW	FC Current Power B	Free Cooling current power, circuit B
fcMaxPwB	-	-	kW	FC Max Power B	Free Cooling maximum power, circuit B
fc_ev_rq	close/open	open	-	FC Evap Valve Request	Free Cooling evaporator valve requested position (option 305A/305B)
fc_cv_rq	close/open	close	-	FC Coil Valve Request	Free Cooling coil valve requested position (option 305A/305B)

7 - CONNECT TOUCH CONTROL: MENU STRUCTURE



Hydraulic Free Cooling Menu – HYD_FC (continued)

Name	Status	Default	Unit	Displayed text*	Description
fc_ev_st	0 to 8	-	-	FC Evap Valve Status	Free Cooling evaporator valve status (option 305A/B): 0 = closing 1 = closed 2 = opening 3 = opened 4 = unknown position 5 = testing 7 = inputs reading failure (alarm 10222 is triggered) 8 = valve blocked (alarm 10222 is triggered)
fc_cv_st	0 to 8	-	-	FC Coil Valve Status	Free Cooling coil valve status (option 305A/B): 0 = closing 1 = closed 2 = opening 3 = opened 4 = unknown position 5 = testing 7 = inputs reading failure (alarm 10220 is triggered) 8 = valve blocked (alarm 10220 is triggered)
				Glycol Free Option	Free Cooling for glycol-free applications (option 305C)
fc_pump	off/on	off	-	FC Coil Pump Cmd	Free Cooling coil pump command: on = FC mode active, anti-sticking mode off = FC mode inactive
fcPumpOv	0 to 6	-	-	FC Coil Pump Override	FC coil pump override: 0 = pump off (no free cooling demand) 1 = unit pump off (waiting for the chiller pump to start first) 2 = in operation (pump is "on" in Free Cooling) 3 = fan off (pump is "off" in Free Cooling and all fans are "off") 4 = in quick test (pump is "on" in Quick Test mode) 5 = failure (pump is "off" / hydronic kit alarm) 6 = anti sticking (pump is "on" in Anti-Sticking mode)
PMP_CAL	no/yes	no	-	Pump Pres. Calibration?	Pump pressure calibration?
fc_wpOut	-	-	kPa/PSI	FC Outlet Water Pres Cor	FC outlet water pressure (pressure correction)
fc_wpIn	-	-	kPa/PSI	FC Inlet Water Pres Cor	FC inlet water pressure (pressure correction)
fc_wpOff	-	-	kPa/PSI	FC Water Pump Offset	FC water pump pressure offset
fc_htr	off/on	off	-	FC Heater Cmd	FC heater requested state (freeze protection mode)

* Depends on the selected language (French by default).



Setpoint Configuration Menu – SETPOINT

Name	Status	Default	Unit	Displayed text*	Description
csp1	-28.9 to 26 -20.0 to 78.8	6.7 44	°C °F	Cooling Setpoint 1	Cooling setpoint 1
csp2	-28.9 to 26 -20.0 to 78.8	6.7 44	°C °F	Cooling Setpoint 2	Cooling setpoint 2
ice_sp	-28.9 to 26 -20.0 to 78.8	6.7 44	°C °F	Cooling Ice Setpoint	Cooling ice setpoint
cramp_sp	0.1 to 1.1 0.2 to 2.0	0.6 1	^C ^F	Cooling Ramp Loading	Cooling ramp loading
hsp1	20.30 to 63 68.0 to 145.4	37.8 100	°C °F	Heating Setpoint 1	Heating setpoint 1
hsp2	20.30 to 63.64 68.0 to 145.4	37.8 100	°C °F	Heating Setpoint 2	Heating setpoint 2
hramp_sp	0.11 to 1.12 0.2 to 2.0	0.6 1	^C ^F	Heating Ramp Loading	Heating ramp loading
cauto_sp	3.9 to 50 39.0 to 122.0	23.9 75	°C °F	Cool Changeover Setpt	Cooling changeover setpoint
hautosp	0 to 46.1 32.0 to 115.0	17.8 64.0	°C °F	Heat Changeover Setpt	Heating changeover setpoint
lim_sp1	0 to 100	100	%	Switch Limit Setpoint 1	Switch limit setpoint 1
lim_sp2	0 to 100	100	%	Switch Limit Setpoint 2	Switch limit setpoint 2
lim_sp3	0 to 100	100	%	Switch Limit Setpoint 3	Switch limit setpoint 3
hr_stp	25.0 to 65.0 77.0 to 149.0	50 122	°C °F	Heat Reclaim Setpoint	Heat reclaim setpoint
hr_deadb	0.5 to 5.0 0.9 to 9.0	2.0 3.6	^C ^F	Heat Reclaim Deadband	Heat reclaim deadband

7 - CONNECT TOUCH CONTROL: MENU STRUCTURE



Setpoint Configuration Menu – SETPOINT (continued)

Name	Status	Default	Unit	Displayed text*	Description
min_sct	23.9 to 50.0 75.0 to 122.0	40.0 104.0	°C °F	Desuperheat Min SCT	Desuperheater minimum saturated condensing temperature

* Depends on the selected language (French by default).

Quick Test #1 Menu – QCK_TST1

Name	Status	Unit	Displayed text*	Description
			Unit must be in Loff	To enable the Quick Test functionality, the unit must be stopped (Local off mode).
QCK_TEST	no/yes	-	Quick Test Enable	This parameter is used to enable the Quick Test functionality (Quick test Enable = yes) With Quick Test enabled: Forcing a specific parameter given in this table allows the user to verify if the component behaves correctly
Q_PUMP_1	0 to 2	-	Pump #1 Output	Pump 1 test: 0 = No test 1 = [ON] Pump shall run for 20 seconds 2 = [FORCED] Pump shall run all the time (set the value to "0" to stop the pump test)
Q_PUMP_2	0 to 2	-	Pump #2 Output	Pump 2 test: 0 = No test 1 = [ON] Pump shall run for 20 seconds 2 = [FORCED] Pump shall run all the time (set the value to "0" to stop the pump test)
Q_VPUMP1	0 to 100	%	Variable Pump Speed #1	Variable speed pump 1 test
Q_VPUMP2	0 to 100	%	Variable Pump Speed #2	Variable speed pump 2 test
Q_HEATER	off/on	-	Exchanger Heater Output	Water exchanger heater test
Q_ALARM	off/on	-	Alarm Relay Status	Alarm relay test
Q_RUN	off/on	-	Running Relay Status	Running relay test
Q_SETFLO	off/on	-	Set Flow Switch	Flow switch test
Q_RV_A	off/on	-	Reverse Vlv Output Cir A	Reverse valve test, circuit A
Q_FAN_A1	off/on	-	Fan A1 Output	Fan stage A1, circuit A
Q_FAN_A2	off/on	-	Fan A2 Output	Fan stage A2, circuit A
Q_FAN_A3	off/on	-	Fan A3 Output	Fan stage A3, circuit A
Q_FAN_A4	off/on	-	Fan A4 Output	Fan stage A4, circuit A
Q_FAN_A5	off/on	-	Fan A5 Output	Fan stage A5, circuit A
Q_FAN_A6	off/on	-	Fan A6 Output	Fan stage A6, circuit A
Q_VFAN_A	0 to 100	%	Variable Fan Speed A	Variable speed fan test, circuit A
Q_EXV_A	0 to 100	%	EXV Position Circuit A	EXV position, circuit A 100% = EXV fully open
Q_HD_HTA	off/on	-	Compressor Head Heater A	Compressor head heater test, circuit A
Q_RV_B	off/on	-	Reverse Vlv Output Cir B	Reverse valve test, circuit B
Q_FAN_B1	off/on	-	Fan B1 Output	Fan stage B1, circuit B
Q_FAN_B2	off/on	-	Fan B2 Output	Fan stage B2, circuit B
Q_FAN_B3	off/on	-	Fan B3 Output	Fan stage B3, circuit B
Q_FAN_B4	off/on	-	Fan B4 Output	Fan stage B4, circuit B
Q_FAN_B5	off/on	-	Fan B5 Output	Fan stage B5, circuit B
Q_FAN_B6	off/on	-	Fan B6 Output	Fan stage B6, circuit B
Q_VFAN_B	0 to 100	%	Variable Fan Speed B	Variable speed fan test, circuit B
Q_EXV_B	0 to 100	%	EXV Position Circuit B	EXV position, circuit B 100% = EXV fully open
Q_HD_HTB	off/on	-	Compressor Head Heater B	Compressor head heater test, circuit B
HP_TEST	0 to 4	-	High Pressure Test	High Pressure test: When activated, the unit will run until the High Pressure Safety Switch is open (0 = No test)
			1: HP test on cir A	1 = High Pressure test, circuit A
			2: HP test on cir B	2 = High Pressure test, circuit B
			3: N/A	3 = <i>Not applicable</i>
			4: HP test on both cir	4 = High Pressure test on both circuits
			HEAT RECLAIM	Heat Reclaim test
QHR_PMP	off/on	-	Reclaim pump command	Heat Reclaim pump command
QHR_3WV	0 to 100	%	Reclaim 3Way Valve cmd	3-way valve command
QHR_HTR	off/on	-	Reclaim BPHE Heater	Heat Reclaim BPHE heater

7 - CONNECT TOUCH CONTROL: MENU STRUCTURE

Quick Test #1 Menu – QCK_TST1 (continued)

Name	Status	Unit	Displayed text*	Description
			HYDRAULIC FREE COOLING	Hydraulic Free Cooling (option 305A/305B/305C)
Q_FC_EV	close/open	-	FC Evaporator Valve	Free Cooling evaporator valve test (option 305A/305B) "FC Evaporator Valve Failure" warning (10222) will be triggered if the controller reports the valve failure. The status of the valve will be displayed in the Hydraulic Free Cooling menu (HYD_FC, fc_ev_st): <ul style="list-style-type: none"> Inputs reading failure (status = 7) Blocked valve failure (status = 8)
Q_FC_CV	close/open	-	FC Coil Valve	Free Cooling coil valve test (option 305A/305B) "FC Coil Valve Failure" warning (10220) will be triggered if the controller reports the valve failure. The status of the valve will be displayed in the Hydraulic Free Cooling menu (HYD_FC, fc_cv_st): <ul style="list-style-type: none"> Inputs reading failure (status = 7) Blocked valve failure (status = 8)
Q_FC_PMP	off/on	-	FC Coil Pump	Free Cooling coil pump test (option 305C)
Q_FC_HTR	off/on	-	FC Heater	Free Cooling heater test (option 305C)

* Depends on the selected language (French by default).

IMPORTANT: To enable the Quick Test functionality, the unit must be stopped (Local off mode).

Trendings – TRENDING

Name	Status	Unit	Displayed text*	Description**
GENUNIT_CAPA_T	0 to 100	%	Cir A Total Capacity	Total capacity, circuit A
GENUNIT_CAPB_T	0 to 100	%	Cir B Total Capacity	Total capacity, circuit B
GENUNIT_CTRL_PNT	-	°C / °F	Control Point	Control point
TEMP_OAT	-	°C / °F	Outdoor Air Temp	Outdoor air temperature
TEMP_EWT	-	°C / °F	Cooler Entering Fluid	Evaporator entering water temperature
TEMP_LWT	-	°C / °F	Cooler Leaving Fluid	Evaporator leaving water temperature
TEMP_SCT_A	-	°C / °F	Saturated Cond Tmp cir A	Saturated condensing temperature, circuit A
TEMP_SCT_B	-	°C / °F	Saturated Cond Tmp cir B	Saturated condensing temperature, circuit B
TEMP_SST_A	-	°C / °F	Saturated Suction Temp A	Saturated suction temperature, circuit A
TEMP_SST_B	-	°C / °F	Saturated Suction Temp B	Saturated suction temperature, circuit B
TEMP_HR_CtrWat	-	°C / °F	Reclaim controlled water	Heat Reclaim control water temperature
TEMP_HR_LWT	-	°C / °F	HR Leaving Fluid temp	Heat Reclaim leaving fluid temperature

* Depends on the selected language (French by default).

** The list of trending points cannot be modified. Trending points can only be enabled or disabled.

Energy Monitoring – ENERGY

Name	Status	Unit	Displayed text*	Description
			ENERGY METER	Energy meter (option 294)
p_total	-	kW	Total active power**	Active power (true power)
e_total	-	kWh	Total Active Energy**	Energy consumption since commissioning or energy meter replacement
e_reset	-	kWh	Partial Active Energy**	Energy consumption since the last reset of the energy meter
p_max	-	kW	Max active power**	Maximum active power demand
sglPhs_I	-	A	Single phase current**	Current per phase
volt_L12	-	V	Voltage L1-L2**	Voltage (L1 – L2)
THD	-	%	Total harmonic distortio**	Total harmonic distortion
pow_fact	-	-	Power factor**	Power factor
			COOLING MODE	Cooling mode
cPwrOut	-	kW	Cooling Power Output	Cooling Power Output
cPwrIn	-	kW	Electical Power Input	Electrical power input of Compressors and fans. Pumps excluded. If EC fans selected: value is estimated. <i>Note: For units with option 294, the Energy Meter "Active Power" is displayed instead of the estimated power consumption.</i>
eer	-	-	Energy Efficiency (EER)	Energy Efficiency (EER)
cEnergyOu	-	kWh	Cooling Energy Output	Cooling Energy Output
cEnergyIn	-	kWh	Electrical Energy Input	Electrical Energy Input
energEer	-	-	Integrated EER	Integrated EER

7 - CONNECT TOUCH CONTROL: MENU STRUCTURE



Energy Monitoring – ENERGY (continued)

Name	Status	Unit	Displayed text*	Description
			HEATING MODE	Heating mode
hPwrOut	-	kW	Heating Power Output	Heating Power Output
hPwrIn	-	kW	Electical Power Input	Electrical power input of Compressors and fans. Pumps excluded. If EC fans selected: value is estimated. <i>Note: For units with option 294, the Energy Meter "Active Power" is displayed instead of the estimated power consumption.</i>
cop	-	-	Coef. Of Perf. (COP)	Coefficient Of Perf. (COP)
hEnergOu	-	kWh	Heating Energy Output	Heating Energy Output
hEnergIn	-	kWh	Electrical Energy Input	Electrical Energy Input
energCop	-	-	Integrated COP	Integrated COP
reset_en	no/yes	-	Reset of Energy Counter	Parameter set to "yes" allows to reset the energies displayed in this table
reset_da	-	-	Last Reset Date	Last Reset Date
reset_ti	-	-	Last Reset Time	Last Reset Time

* Depends on the selected language (French by default).

For units without option 294 (Energy Meter): The information in this table is indicative (based on estimates) and cannot be used as a real energy meter. This estimation does not take into account the pump consumption.

**For units with option 294 (Energy Meter): These values are updated with data coming from the Energy Meter.

If the unit is not equipped with the Energy Meter, these parameters' values are set to "0".



Software Options – OPT_STA

Name	Status	Unit	Displayed text*	Description
opt6	no/yes	-	OPT6: Low Brine	Parameter set to "yes" means that Low brine option which requires the Software Key is activated
opt149	no/yes	-	OPT149: BACnet	Parameter set to "yes" means that BACnet option which requires the Software Key is activated
opt149B	no/yes	-	OPT149B: Modbus	Parameter set to "yes" means that Modbus option is activated
opt119C	no/yes	-	OPT119C: Cool Floor Optim	Parameter set to "yes" means that Cooling Floor Optimized option which requires the Software Key is activated (specific circuit capacity limits are applied to heat pumps in Cooling mode)
opt295	no/yes	-	OPT295: Fast Cap Reco	Parameter set to "yes" means that Fast Capacity Recovery option which requires the Software Key is enabled

* Depends on the selected language (French by default).

7 - CONNECT TOUCH CONTROL: MENU STRUCTURE

7.2 Configuration menu (CONFIG)

Icon	Displayed text*	Description	Name
	General Configuration	General configuration	GENCONF
	Pump Configuration	Pump configuration	PUMPCONF
	Reset Configuration	Reset configuration	RESETCFG
	Backup Configuration	Backup configuration	BACKUP
	User Configuration	User configuration	USERCONF
	Schedule Menu	Schedule menu	SCHEDULE
	Holiday Menu	Holiday menu	HOLIDAY
	Date/Time Configuration	Date/time configuration	DATETIME
	Network Parameters	Network parameters (see section 7.3)	NETWORKS
	Control Identification	Control identification	CTRL_ID
	Add Options	Add Options	ADD_OPT
	Heat Reclaim Config	Heat Reclaim Configuration	HR_CFG

* Depends on the selected language (French by default).

CAUTION

Since specific units may not include additional features, some tables may contain parameters that are not relevant and cannot be configured for a given unit.



General Configuration Menu – GENCONF

Name	Status	Default	Unit	Displayed text*	Description
prio_cir	0 to 2	0	-	Cir Priority Sequence	Circuit priority
				0=Auto, 1=A Prio	0 = Automatic circuit selection 1 = Circuit A priority
				2=B Prio	2 = Circuit B priority
seq_typ	no/yes	no	-	Staged Loading Sequence	Staged loading sequence
ramp_sel	no/yes	no	-	Ramp Loading Select	Ramp loading selection
lim_sel	0 to 2	0	-	Demand Limit Type Select	Demand limit selection
				0 = None	0 = None
				1 = Switch Control	1 = Switch control
				2 = 4-20mA Control	2 = 4-20 mA control
lim_mx	0 to 20	0	mA	mA For 100% Demand Limit	100% demand limit (mA)
lim_ze	0 to 20	10	mA	mA For 0% Demand Limit	0% demand limit (mA)
off_on_d	1 to 15	1	min	Unit Off to On Delay	Unit Off to On delay

7 - CONNECT TOUCH CONTROL: MENU STRUCTURE



General Configuration Menu – GENCONF (continued)

Name	Status	Default	Unit	Displayed text*	Description
heat_th	-17.0 to 0 1.4 to 32.0	-17.0 1.4	°C °F	Heating OAT Threshold	Heating OAT threshold
nh_start	-	-	-	Night Mode Start Hour	Night mode start hour
nh_end	-	-	-	Night Mode End Hour	Night mode end hour
nh_limit	0 to 100	100	%	Night Capacity Limit	Night capacity limit
ice_cnfg	no/yes	no	-	Ice Mode Enable	Ice mode enabled (Energy Management Module)
both_sel	no/yes	no	-	Both Command Sel (HSM)	Both command selection (HSM)
auto_sel	no/yes	no	-	Auto Changeover Select	Automatic changeover selection
ewt_opt	no/yes	no	-	Entering Fluid Control	Entering fluid control option (if selected, the system controls unit capacity based on the entering fluid temperature; otherwise the control is based on the leaving fluid temperature)

* Depends on the selected language (French by default).



Pump Configuration Menu – PUMPCONF

Name	Status	Default	Unit	Displayed text*	Description
pump_seq	0 to 4	1	-	Pumps Sequence	Pumps sequence
				0 = No Pump	0 = No pump
				1 = One Pump Only	1 = One pump only (units with one pump)
				2 = Two Pumps Auto	2 = Two pumps automatic control
				3 = Pump#1 Manual	3 = Pump 1 selected (units with two pumps)
				4 = Pump#2 Manual	4 = Pump 2 selected (units with two pumps)
pump_del	24 to 3000	48	hour	Pump Auto Rotation Delay	Pump automatic rotation delay
pump_per	no/yes	no	-	Pump Sticking Protection	Pump sticking protection
pump_sby	no/yes	no	-	Stop Pump During Standby	Pump stops when the unit is in standby
pump_loc	no/yes	yes	-	Flow Checked If Pump Off	Flow checked if pump is off
flow_ctl	1 to 3	1	-	Flow Control Method	Flow control method
				1 = Constant Speed	1 = flow control is based on fixed pump speed
				2 = Delta Temperature	2 = flow control is based on delta temperature
				3 = Delta Pressure	3 = flow control is based on delta pressure
dt_stp	3.0 to 10.0 5.4 to 18.0	5.0 9.0	°C °F	Flow Delta T Setpoint	Delta temperature setpoint
dp_stp	50.0 to 300.0 7.25 to 43.51	200.0 29.0	kPa PSI	Flow Delta P Setpoint	Delta pressure setpoint
wtr_zval	-100.0 to 10.0 -14.5 to 1.45	-100.0 -14.5	kPa PSI	Pressure Zero Value	Pressure zero value
pump_min	30 to 100	60	%	Pump Minimum Speed	Minimum pump speed
pump_sav	30 to 100	60	%	Pump Min Speed Cap=0%	Minimum pump speed when unit capacity is 0%
pump_max	30 to 100	100	%	Pump Maximum Speed	Maximum pump speed
MinWpThr	70.0 to 1000.05 10.15 to 145.04	100.0 14.5	kPa PSIG	Min Water Press Thres	Minimum water pressure threshold
WtPmpMxP	96.5 to 551.5 14.0 to 80.0	500.0 72.52	kPa PSIG	Water Pump Max Delta P	Maximum water pump delta pressure

* Depends on the selected language (French by default).



Reset Configuration Menu – RESETCFG

Name	Status	Default	Unit	Displayed text*	Description
cr_sel	0 to 4	0	-	Cooling Reset Select	Cooling reset selection
hr_sel	0 to 4	0	-	Heating Reset Select	Heating reset selection
				0=None, 1=OAT, 2=Delta T	0 = None, 1 = OAT, 2 = Delta T
				3=4-20mA control	3 = 4-20 mA control
				4=Space Temp	4 = Space temperature
				Cooling	Cooling
oat_cmo	-10 to 51.7 14 to 125	-10.0 14.0	°C °F	OAT No Reset Value	OAT, no reset value
oat_crfu	-10 to 51.7 14 to 125	-10.0 14.0	°C °F	OAT Full Reset Value	OAT, max. reset value
dt_cr_no	0 to 13.9 0 to 25	0 0	°C °F	Delta T No Reset Value	Delta T, no reset value

7 - CONNECT TOUCH CONTROL: MENU STRUCTURE



Reset Configuration Menu – RESETCFG (continued)

Name	Status	Default	Unit	Displayed text*	Description
dt_cr_fu	0 to 13.9 0 to 25	0 0	^C ^F	Delta T Full Reset Value	Delta T, max. reset value
l_cr_no	0 to 20	0	mA	Current No Reset Value	Current, no reset value
l_cr_fu	0 to 20	0	mA	Current Full Reset Value	Current, max. reset value
spacr_no	-10 to 51.7 14 to 125	-10.0 14	°C °F	Space T No Reset Value	Space temperature, no reset value
spacr_fu	-10 to 51.7 14 to 125	-10.0 14	°C °F	Space T Full Reset Value	Space temperature, max. reset value
cr_deg	-16.7 to 16.7 -30 to 30	0 0	^C ^F	Cooling Reset Deg. Value	Maximum cooling reset value
				Heating	Heating
oat_hrno	-10 to 51.7 14 to 125	-10.0 14.0	°C °F	OAT No Reset Value	OAT, no reset value
oat_hrfu	-10 to 51.7 14 to 125	-10.0 14.0	°C °F	OAT Full Reset Value	OAT, max. reset value
dt_hr_no	0 to 13.9 0 to 25	0 0	^C ^F	Delta T No Reset Value	Delta T, no reset value
dt_hr_fu	0 to 13.9 0 to 25	0 0	^C ^F	Delta T Full Reset Value	Delta T, max. reset value
l_hr_no	0 to 20	0	mA	Current No Reset Value	Current, no reset value
l_hr_fu	0 to 20	0	mA	Current Full Reset Value	Current, max. reset value
spahr_no	-10 to 51.7 14 to 125	-10.0 14.0	°C °F	Space T No Reset Value	Space temperature, no reset value
spahr_fu	-10 to 51.7 14 to 125	-10.0 14.0	°C °F	Space T Full Reset Value	Space temperature, max. reset value
hr_deg	-16.7 to 16.7 -30 to 30	0 0	^C ^F	Heating Reset Deg. Value	Maximum heating reset value
				Smart Grid Ready Option	Smart Grid Ready option
heat_sg3	0 to 77.8 0 to 140	0 0	^C ^F	Boost Heat Offset	Smart Grid Ready: Heating offset (BOOST mode)
cool_sg3	0 to 77.8 0 to 140	0 0	^C ^F	Boost Cool Offset	Smart Grid Ready: Cooling offset (BOOST mode)
heat_sg4	0 to 77.8 0 to 140	0 0	^C ^F	Forced Heat Offset	Smart Grid Ready: Heating offset (FORCED mode)
cool_sg4	0 to 77.8 0 to 140	0 0	^C ^F	Forced Cool Offset	Smart Grid Ready: Cooling offset (FORCED mode)

* Depends on the selected language (French by default).



Backup Configuration Menu – BACKUP

Name	Status	Default	Unit	Displayed text*	Description
boil_th	-15 to 15 5 to 59	-10.0 14.0	°C °F	Boiler OAT Threshold	Boiler OAT threshold
ehs_th	-5 to 21 23 to 70	5.0 41.0	°C °F	Elec Stage OAT Threshold	Electric heater stage OAT threshold
ehs_pull	0 to 60	0	min	Electrical Pulldown Time	Electrical pulldown time
ehs_back	no/yes	no	-	Last EHS for backup	Last electric heater stage for backup
ehs_defr	no/yes	no	-	Quick EHS for defrost	Quick EHS for defrost
ehs_kp	-20 to 20	2	-	EHS Proportional Gain	EHS proportional gain
ehs_ki	-5 to 5	0	-	EHS Integral Gain	EHS integral gain
ehs_kd	-20 to 20	0	-	EHS Derivative Gain	EHS derivative gain
ht_sgr	-20 to 0 -4 to 32	-15.0 5.0	°C °F	SGR Boiler OAT Thres	Smart Grid Ready option: Boiler OAT threshold

* Depends on the selected language (French by default).

7 - CONNECT TOUCH CONTROL: MENU STRUCTURE



User Configuration Menu – USERCONF

Name	Status	Default	Unit	Displayed text*	Description
alert_r	no/yes	no	-	Alarm Relay for Alerts?	Alarm relay status. Alarm output relay is used for "alarm" + "alert"
al_rever	0 to 1	0	-	Reversed Alarm Relay	Alarm / Alert signals reverted No (0) = standard operation Yes (1) = alarm/alert/shutdown outputs are "On" even if there is no alarm/alert (alarm output unavailable)
				PHASE CONTROLLER	Phase controller (option 159B)
PhCtrAct	0 to 2	0	-	Phase Controller Action	This parameter is used to define the action taken in case the Phase Controller detects a fault. 0 = Alert: No action taken on the unit (default setting). 1 = Alarm: The unit shuts down when the alarm is active. The alarm reset is automatic. 2 = Alarm: The unit shuts down when the alarm is active. The alarm must be reset manually. <i>Note: To prevent any unit damage due to unstable power supply conditions, it is recommended to set this parameter to "1" or "2".</i>
PCMinTim	0 to 600	120	sec	PC Minimum Fault Time	This parameter defines the minimum duration of the Phase Controller alert/alarm (alert/alarm 10054).

* Depends on the selected language (French by default).



Schedule Menu – SCHEDULE

Name	Displayed text*	Description
OCCPC01S	OCCPC01S - Schedule Menu	Unit on/off time schedule
OCCPC02S	OCCPC02S - Schedule Menu	Unit setpoint selection time schedule

* Depends on the selected language (French by default).



Holiday Menu – HOLIDAY

Point name	Status	Unit	Displayed text*	Description
HOL_MON	0-12	0	Holiday Start Month	Holiday start month
HOL_DAY	0-31	0	Start Day	Holiday start day
HOL_LEN	0-99	0	Duration (days)	Holiday duration (days)

* Depends on the selected language (French by default).



Date/Time Configuration Menu – DATETIME

Displayed text*		Status	Description
Connect Touch	Connect Touch 2.0		
Daylight Saving Time	-	on/off	Summer / winter time activation
Location	Location	UTC	Time zone (Connect Touch 2.0: Time zone setting includes DST control)
Date/Time	Date/Time	YYYY/MM/DD, HH:MM:SS	Current date and time (must be set manually)
Today is a Holiday	Today is a Holiday	no/yes	Information about holidays (read-only). Please note that holidays are set in the Holiday menu (see also section 7.2)
Tomorrow is a Holiday	Tomorrow is a Holiday	no/yes	Information about the upcoming holiday period (read-only). Please note that holidays are set in the Holiday menu (see also section 7.2)

* Depends on the selected language (French by default).



Control Identification Menu – CTRLID

Status	Default	Displayed text*	Description
1-239	1	Element Number	Element number
0-239	0	Bus Number	Bus number
9600 / 19200 / 38400	9600	Baud Rate	Communication speed
-	AQP ILD	Device Description	Unit description
-	-	Location Description	Location description
-	020-ST-20V4G010	Software Part Number	Software version
-	-	Serial Number	Serial number (MAC address)

* Depends on the selected language (French by default).

7 - CONNECT TOUCH CONTROL: MENU STRUCTURE



Add Options – ADD_OPT

Displayed text*	Description
MAC address	Controller MAC address: This MAC address is requested by your Local Service representative when ordering any software-protected option
Please Enter Your Software Activation Key:	Type the Software Activation Key provided by your Local Service representative
Unit must be OFF	The unit should not be operating when installing the Software Activation Key

* Depends on the selected language (French by default).



Heat Reclaim Config Menu – HR_CFG

Name	Status	Default	Unit	Displayed text*	Description
hrVarPmp	no/yes	no	-	HR variable speed pump ?	Heat Reclaim variable-speed pump selection: no = 3-way valve is used yes = variable speed pump is used
hr_flui	water/brine	water	-	HR condenser fluid	Heat Reclaim condenser fluid type: 0 = water, 1 = brine
hr_eco	off/on	off	-	HR eco mode ?	Heat Reclaim "Eco" mode: on = fans disabled in Heat Reclaim (Heat Reclaim efficiency priority) off = fans enabled in Heat Reclaim (chiller efficiency priority)
rev_3WV	no/yes	no	-	HR reverse 3WV cmd ?	Heat Reclaim 3-way valve reversed command:
				NO : 0V = close	no = 0V, 3-way valve fully closed (water flow depends on "Min flow 3wv position" set in the HR_CFG table)
				YES : 0V = open	yes = 0V, 3-way valve fully opened (there is water flow in the condenser and in the customer loop)
HRewtctl	no/yes	yes	-	HR Control on EWT ?	Heat Reclaim control: no = HR control on water leaving the 3-way valve (if the sensor is located after the 3-way valve) yes = HR control on water entering the 3-way valve (if the sensor is located before the 3-way valve)
kp_HR3wv	-20 to 20	2	-	PID gain prop 3w valve	3-way valve / pump PID proportional gain
ki_HR3wv	-5 to 5	0.2	-	PID gain int 3w valve	3-way valve / pump PID integral gain
kd_HR3wv	-20 to 20	0.4	-	PID gain deri 3w valve	3-way valve / pump PID derivative gain
kp_HRFan	-20 to 20	5	-	PID gain prop fan	Fan PID proportional gain
ki_HRFan	-5 to 5	0.5	-	PID gain int fan	Fan PID integral gain
kd_HRFan	-20 to 20	0	-	PID gain deri fan	Fan PID derivative gain
minHRpmp	15 to 60	30	%	HR VarPump min pos	Minimum variable-speed pump speed in Heat Reclaim
maxHR3wv	70 to 100	100	%	3WayValve/VarPmp max pos	Maximum 3-way valve position (or variable-speed pump speed) in Heat Reclaim mode
flowTmr	10 to 120	20	sec	HR delay flow switch	Heat Reclaim flow switch delay timer (see alert 10052)
minFloEn	no/yes	no	-	Min flow 3wv enable	3-way valve minimum flow setting: no = Anti-freeze protection disabled yes = Anti-freeze protection enabled. When Heat Reclaim is not active and the outside air temperature is low, the 3-way valve will be opened to its pre-configured position ("Min flow 3wv position").
minFlow	10 to 100	15	%	Min flow 3wv position	Minimum 3-way valve position used to ensure minimum fluid flow and prevent it from freezing
min_wt	-10.0 to 1.1 14.0 to 34.0	1.1 34.0	°C °F	HR Min water temp	Minimum water temperature in Heat Reclaim mode: If the temperature drops below this setting, an alert will be raised (10128). HR condenser heater will be energized (if present), HR mode will be off and the pump will be turned on.

* Depends on the selected language (French by default).

7.3 Network Parameters menu

Icon	Displayed text*	Description	Name
	Email Configuration	Email configuration	EMAILCFG
	Modbus RTU Config.	Modbus RTU configuration	MODBUSRS
	Modbus TCP/IP Config	Modbus TCP/IP configuration	MODBUSIP

7 - CONNECT TOUCH CONTROL: MENU STRUCTURE

Icon	Displayed text*	Description	Name
	BACnet Standard Conf.	BACnet standard configuration	BACNET

* Depends on the selected language (French by default).

Email Configuration Menu – EMAILCFG

Name	Status	Default	Unit	Displayed text*	Description
senderP1	"xx chars"			Sender Email Part1	Sender e-mail, identifier part
				@	@
senderP2	"xx chars"			Sender Email Part2	Sender e-mail, domain part
recip1P1	"xx chars"			Recip1 Email Part1	Recipient 1, identifier part
				@	@
recip1P2	"xx chars"			Recip1 Email Part2	Recipient 1, domain part
recip2P1	"xx chars"			Recip2 Email Part1	Recipient 2, identifier part
				@	@
recip2P2	"xx chars"			Recip2 Email Part2	Recipient 2, domain part
smtpP1	0 to 255	0	-	SMTP IP Addr Part 1	SMTP IP address part 1
smtpP2	0 to 255	0	-	SMTP IP Addr Part 2	SMTP IP address part 2
smtpP3	0 to 255	0	-	SMTP IP Addr Part 3	SMTP IP address part 3
smtpP4	0 to 255	0	-	SMTP IP Addr Part 4	SMTP IP address part 4
accP1	-	-	-	Account Email Part1	Account e-mail, identifier part
				@	@
accP2	-	-	-	Account Email Part2	Account e-mail, domain part
accPass	-	-	-	Account Password	Account password
portNbr	0 to 65535	25	-	Port Number	Port number
srvTim	0 to 255	30	sec	Server Timeout	Server timeout
srvAut	0 to 1	0	-	Server Authentication	Server authentication

* Depends on the selected language (French by default).

Modbus RTU Config. Menu – MODBUSRS

Name	Status	Default	Unit	Displayed text*	Description
modrt_en	no/yes	0	-	RTU Server Enable	RTU Server Enable
ser_UID	1 to 247	1	-	Server UID	Server UID
metric	no/yes	1	-	Metric Unit	Metric Unit
swap_b	0 to 1	0	-	Swap Bytes	Swap Bytes
				0 = Big Endian	0 = Big Endian
				1 = Little Endian	1 = Little Endian
baudrate	0 to 2	0	-	Baudrate	Baudrate
				0 = 9600	0 = 9600
				1 = 19200	1 = 19200
				2 = 38400	2 = 38400
parity	0 to 2	0	-	Parity	Parity
				0 = No parity	0 = No parity
				1 = Odd parity	1 = Odd parity
				2 = Even parity	2 = Even parity
stop_bit	0 to 1	0	-	Stop bit number	Stop bit number
				0 = One stop bit	0 = One stop bit
				1 = Two stop bit	1 = Two stop bit
real_typ	0 to 1	1	-	Real Type Management	Real Type Management
				0 = Float X10	0 = Float X10
				1 = IEE 754	1 = IEE 754
reg32bit	0 to 1	1	-	Enable 32 bits registers	Enable 32 bits registers
				0 = IR/HR in 16 bit mode	0 = IR/HR in 16 bit mode
				1 = IR/HR in 32 bit mode	1 = IR/HR in 32 bit mode

* Depends on the selected language (French by default).

7 - CONNECT TOUCH CONTROL: MENU STRUCTURE



Modbus TCP/IP Config. Menu – MODBUSIP

Name	Status	Default	Unit	Displayed text*	Description
modip_en	no/yes	no	-	TCP/IP Server Enable	TCP/IP Server Enable
ser_UID	1 to 247	1	-	Server UID	Server UID
port_nbr	0 to 65535	502	-	IP Port Number	IP Port Number
metric	no/yes	yes	-	Metric Unit	Metric Unit
swap_b	0 to 1	0	-	Swap Bytes	Swap Bytes
				0 = Big Endian	0 = Big Endian
				1 = Little Endian	1 = Little Endian
real_typ	0 to 1	1	-	Real Type Management	Real Type Management
				0 = Float X10	0 = Float X10
				1 = IEE 754	1 = IEE 754
reg32bit	0 to 1	1	-	Enable 32 bits registers	Enable 32 bits registers
				0 = IR/HR in 16 bit mode	0 = IR/HR in 16 bit mode
				1 = IR/HR in 32 bit mode	1 = IR/HR in 32 bit mode
conifnam	0 to 1	0	-	IP port interface name	IP port interface name
				0 = J5/J15	0 = J5/J15
				1 = J16	1 = J16
timeout	60 to 600	120	sec	Com. timeout (s)	Com. timeout (s)
idle	0 to 30	10	sec	Keepalive idle delay(s)	Keepalive idle delay(s)
intrvl	0 to 2	1	sec	Keepalive interval(s)	Keepalive interval(s)
probes	0 to 10	10	-	Keepalive probes nb	Keepalive probes number

* Depends on the selected language (French by default).



BACnet Standard Conf. – BACNET









Name	Status	Default	Unit	Displayed text*	Description
bacena	0 to 2	0	-	BACnet Enable	BACnet Enable: 0 = Disabled 1 = BACnet IP 2 = BACnet MS/TP (Manager Subordinate / Token Passing)
bacunit	no/yes	yes	-	Metric Unit?	Metric Unit?
network	1 to 4000	1600	-	Network	Network
udpport	47808 to 47823	47808	-	UPD Port Number	UPD Port Number
bac_id	1 to 4194302	1600001	-	Device Id Manual	Device Id Manual
auid_opt	disable/enable	disable	-	Device Id Auto Option	Device Id Auto Option
balmena	disable/enable	enable	-	Alarm reporting	Alarm reporting
mng_occ	no/yes	no	-	BACnet Manage Occupancy	BACnet Manage Occupancy
conifnam	0 to 1	0	-	IP port Interface name	IP port Interface name
				0 = J5/J15	0 = J5/J15
				1 = J16	1 = J16
mstpaddr	1 to 127	1	-	BACnet MAC address	BACnet MS/TP MAC address
mstpbaud	0 to 5	2	-	BACnet_baud_enum	BACnet MS/TP baud rate:
				0 = 9600	0 = 9600
				1 = 19200	1 = 19200
				2 = 38400	2 = 38400
				3 = 57600	3 = 57600
				4 = 79800	4 = 79800
				5 = 115200	5 = 115200
maxmastr	1 to 127	10	-	mstp_max_master	Maximum number of Manager (master) nodes in BACnet MS/TP network (master node can initiate requests only when it holds the token)
maxinfof	1 to 255	10	-	mstp_max_info_frames	Maximum number of data frames (messages) the master node can transmit before passing the token

* Depends on the selected language (French by default).

NOTE: BACnet MS/TP option is available only on Connect Touch 2.0.

7 - CONNECT TOUCH CONTROL: MENU STRUCTURE

7.4 System Menu

Icon	Displayed text*	Description	Name
	CPU Load	CPU Load Menu	CPULOAD
	EOL Resistor	EOL Resistor Menu	EOLRES
	Network	Network Menu	NETWORK
	Date/Time Configuration	Date/Time Configuration	DATETIME
	Language & Unit System	Language & Unit System Menu	LANGUNIT
	Brightness	Brightness	BRIGHTNS
	Software Info	Software Info Menu	SWINFO
	Hardware Info	Hardware Info Menu	HWINFO

* Depends on the selected language (French by default).



CPU Load Menu – CPULOAD

Status	Default	Unit	Displayed text*	Description
0 to 100	-	%	CPU load	CPU utilization
0 to 100	-	%	RAM Memory utilization	RAM usage
0 to 100	-	%	FLASH Memory utilization	Flash memory usage

* Depends on the selected language (French by default).



EOL Resistor Menu – EOLRES (not used on Connect Touch 2.0)

Status	Default	Displayed text*	Description
disable/enable	disable	End of Line Res. J6(LEN)	End of line resistor J6 (LEN bus)
disable/enable	disable	End of Line Res. J7	End of line resistor J7
disable/enable	disable	End of Line Resistor J8	End of line resistor J8
disable/enable	disable	End of Line Resistor J10	End of line resistor J10 (Modbus)

* Depends on the selected language (French by default).

NOTE: This menu is not used on 4.3-inch controllers.



Network Menu – NETWORK

Displayed text*		Status	Description
Connect Touch	Connect Touch 2.0		
IP Network Interface J5 (eth0):	Ethernet 0 (J5)		IP network interface J5 (Ethernet 0):
MAC Address	MAC Address	xx:xx:xx:xx:xx:xx	MAC address
-	DHCP	disabled	DHCP
TCP/IP Address	IP Address	169.254.1.1	TCP/IP address: Changing the IP address and mask is possible but a reboot is mandatory if Modbus TCP or BACnet IP is enabled (the reboot is required to make changes effective).
Subnet Mask	Subnet Mask	255.255.255.0	Subnet mask
Default Gateway	Default Gateway	169.254.1.3	Default gateway

7 - CONNECT TOUCH CONTROL: MENU STRUCTURE



Network Menu – NETWORK (continued)

Displayed text*		Status	Description															
Connect Touch	Connect Touch 2.0																	
Gateway Dest/Mask	Gateway Dest/Mask	169.254.0.0/16	Gateway mask in CIDR format <table border="1"> <thead> <tr> <th>Gateway IP address</th> <th>CIDR notation</th> <th>Gateway in CIDR format</th> </tr> </thead> <tbody> <tr> <td>169.254.1.3</td> <td>xxx.xxx.xxx.0/24</td> <td>169.254.1.0/24</td> </tr> <tr> <td>169.254.1.3</td> <td>xxx.xxx.0.0/16</td> <td>169.254.0.0/16</td> </tr> <tr> <td>169.254.1.3</td> <td>xxx.0.0.0/8</td> <td>169.0.0.0/8</td> </tr> <tr> <td>0.0.0.0</td> <td>0.0.0.0/0</td> <td>0.0.0.0/0</td> </tr> </tbody> </table> Note: "xxx" shown in the CIDR notation above refers to the Gateway IP address.	Gateway IP address	CIDR notation	Gateway in CIDR format	169.254.1.3	xxx.xxx.xxx.0/24	169.254.1.0/24	169.254.1.3	xxx.xxx.0.0/16	169.254.0.0/16	169.254.1.3	xxx.0.0.0/8	169.0.0.0/8	0.0.0.0	0.0.0.0/0	0.0.0.0/0
Gateway IP address	CIDR notation	Gateway in CIDR format																
169.254.1.3	xxx.xxx.xxx.0/24	169.254.1.0/24																
169.254.1.3	xxx.xxx.0.0/16	169.254.0.0/16																
169.254.1.3	xxx.0.0.0/8	169.0.0.0/8																
0.0.0.0	0.0.0.0/0	0.0.0.0/0																
Domain Name Server (DNS)	DNS: Primary DNS	169.254.1.3	Domain name server (DNS), primary address															
-	DNS: Alternate DNS	169.254.1.4	Domain name server (DNS), secondary address															

* Depends on the selected language (French by default).



Date/Time Configuration Menu – DATETIME

Displayed text*		Status	Description
Connect Touch	Connect Touch 2.0		
Daylight Saving Time	-	on/off	Summer / winter time activation
Location	Location	UTC	Time zone (Connect Touch 2.0: Time zone setting includes DST control)
Date/Time	Date/Time	YYYY/MM/DD, HH:MM:SS	Current date and time (must be set manually)
Today is a Holiday	Today is a Holiday	no/yes	Information about holidays (read-only). Please note that holidays are set in the Holiday menu (see also section 7.2)
Tomorrow is a Holiday	Tomorrow is a Holiday	no/yes	Information about the upcoming holiday period (read-only). Please note that holidays are set in the Holiday menu (see also section 7.2)

* Depends on the selected language (French by default).



Language & Unit System Menu – LANGUNIT

Displayed text*	Description
(Languages) 	Language list: English, Spanish, French, German, Dutch, Chinese, Italian, Portuguese, and Custom1 Custom language: The control system allows users to add new languages to the control. To learn more about language customization, please contact your local Service representative. Custom languages can be uploaded only by Service representative.
System of measurement: US Imp/Metric	US Imp = Parameters displayed in US Imperial units Metric = Parameters displayed in metric units

* Depends on the selected language (French by default).



Brightness Menu – BRIGHTNS

Displayed text*		Status	Description
Connect Touch	Connect Touch 2.0		
Brightness	Brightness	0 to 100%	Screen brightness
-	Theme Selection	Dark/Light	Theme selection (Dark theme / Light theme)

* Depends on the selected language (French by default).



Software Info Menu – SWINFO

Displayed text*		Status	Description
Connect Touch	Connect Touch 2.0		
Software Version	Software Version	ECG-SR-20VG100	Software version number
SDK Version	SDK Version	N.NNN.N	SDK version number
-	App version	NN.N	Application version
UI Version	UI Version	NN	User interface version
Brand	Brand	CIAT	Brand name

* Depends on the selected language (French by default).

7 - CONNECT TOUCH CONTROL: MENU STRUCTURE



Hardware Info Menu – HWINFO

Status	Displayed text*	Description
-	Board Variant	Board variant
-	Board Revision	Board revision
43	Screen size	Screen size in inches

* Depends on the selected language (French by default).

7.5 Alarm Menu

Icon	Displayed text*	Description	Name
	Reset Alarms	Alarm reset	ALARMRST
	Current Alarms	Current alarms	CUR_ALM
	Alarm Historic	Alarms historic	ALMHIST1
	Major Alarm Historic	Major alarms historic	ALMHIST2

* Depends on the selected language (French by default).



Reset Alarms – ALARMRST

Name	Date	Hour	Alarm text
RST_ALM	no/yes	Alarm Reset	Used to reset active alarms
ALM	-	Alarm State	Alarm state: Normal = No alarm Partial = There is an alarm, but the unit continues to operate Shutdown = Unit shuts down
alarm_1c	-	Current Alarm 1	Alarm code (see section 9.3)
alarm_2c	-	Current Alarm 2	Alarm code (see section 9.3)
alarm_3c	-	Current Alarm 3	Alarm code (see section 9.3)
alarm_4c	-	Current Alarm 4	Alarm code (see section 9.3)
alarm_5c	-	Current Alarm 5	Alarm code (see section 9.3)
alarm_1	-	Current Alarm 1 index	Alarm code (see section 9.3)
alarm_2	-	Current Alarm 2 index	Alarm code (see section 9.3)
alarm_3	-	Current Alarm 3 index	Alarm code (see section 9.3)
alarm_4	-	Current Alarm 4 index	Alarm code (see section 9.3)
alarm_5	-	Current Alarm 5 index	Alarm code (see section 9.3)

* Depends on the selected language (French by default).

7 - CONNECT TOUCH CONTROL: MENU STRUCTURE



Current Alarms – CUR_ALM

Name	Date	Hour	Alarm text
Alarm	YYYY/MM/DD	HH:MM	Alarm text (see section 9.3)
Alarm	YYYY/MM/DD	HH:MM	Alarm text (see section 9.3)
Alarm	YYYY/MM/DD	HH:MM	Alarm text (see section 9.3)

* Depends on the selected language (French by default).



Alarm Historic – ALMHIST1

Name	Date	Hour	Alarm text
Alarm	YYYY/MM/DD	HH:MM	Alarm text (see section 9.3)
Alarm	YYYY/MM/DD	HH:MM	Alarm text (see section 9.3)
Alarm	YYYY/MM/DD	HH:MM	Alarm text (see section 9.3)

* Depends on the selected language (French by default).



Major Alarm Historic – ALMHIST2

Name	Date	Hour	Alarm text
Alarm	YYYY/MM/DD	HH:MM	Alarm text (see section 9.3)
Alarm	YYYY/MM/DD	HH:MM	Alarm text (see section 9.3)
Alarm	YYYY/MM/DD	HH:MM	Alarm text (see section 9.3)

* Depends on the selected language (French by default).

8 - STANDARD CONTROL OPERATIONS AND OPTIONS

8.1 Unit Start / Stop control

The unit state is determined based on a number of factors, including its operating type, active overrides, open contacts, master/slave configuration, or alarms triggered due to operating conditions.

The table given below summarises the unit control type [ctrl_typ] and its running status with regard to the following parameters:

- **Operating type:** This operating type is selected using the **Start/Stop** button on the user interface.
- **Start/stop force command [CHIL_S_S]:** Chiller start/stop force command can be used to control the chiller state in the Network mode.
 - **Command set to stop:** The unit is halted.
 - **Command set to start:** The unit runs in accordance with schedule 1.

- **Remote start/stop contact status [Onoff_sw]:** Start/Stop contact status can be used to control the chiller state in the Remote operating type.
- **Master control type [ms_ctrl]:** When the unit is the master unit in a two-chiller master/slave arrangement, the master unit may be set to be controlled locally, remotely or via network.
- **Start/stop schedule [chil_occ]:** Occupied or unoccupied status of the unit.
- **Network emergency stop command [EMSTOP]:** If activated, the unit shuts down regardless of the active operating type.
- **General alarm:** The unit shuts down due to failure.

Active operating type						Parameters status						Result	
LOFF	L-On	L-SC	Rem	Net	Mast	Start/Stop force command	Remote start/stop contact	Master control type	Start/stop time schedule	Network emergency shutdown	General alarm	Control type	Unit state
-	-	-	-	-	-	-	-	-	-	enabled	-	-	off
-	-	-	-	-	-	-	-	-	-	-	yes	-	off
active	-	-	-	-	-	-	-	-	-	-	-	local	off
-	-	active	-	-	-	-	-	-	unoccupied	-	-	local	off
-	-	-	active	-	-	-	open	-	-	-	-	remote	off
-	-	-	active	-	-	-	-	-	unoccupied	-	-	remote	off
-	-	-	-	active	-	disabled	-	-	-	-	-	network	off
-	-	-	-	active	-	-	-	-	unoccupied	-	-	network	off
-	-	-	-	-	active	-	-	local	unoccupied	-	-	local	off
-	-	-	-	-	active	-	open	remote	-	-	-	remote	off
-	-	-	-	-	active	-	-	remote	unoccupied	-	-	remote	off
-	-	-	-	-	active	disabled	-	network	-	-	-	network	off
-	-	-	-	-	active	-	-	network	unoccupied	-	-	network	off
-	active	-	-	-	-	-	-	-	-	disabled	no	local	on
-	-	active	-	-	-	-	-	-	occupied	disabled	no	local	on
-	-	-	active	-	-	-	closed	-	occupied	disabled	no	remote	on
-	-	-	-	active	-	enabled	-	-	occupied	disabled	no	network	on
-	-	-	-	-	active	-	-	local	occupied	disabled	no	local	on
-	-	-	-	-	active	-	closed	remote	occupied	disabled	no	remote	on
-	-	-	-	-	active	enabled	-	network	occupied	disabled	no	network	on

IMPORTANT: When the unit is stopping or there is a demand to stop the unit, compressors are stopped consecutively. In case of emergency stop, all compressors are stopped at the same time.

8.2 Heating / Cooling control

AQUACIAT^{POWER} heat pumps and chillers fitted with a boiler may operate in cooling or heating mode. The CONNECT TOUCH control determines whether the unit is in the heating or cooling operating mode.

- Without a boiler, the chiller remains in Cooling mode (Heating is NOT possible).
- Heat pumps may operate in Cooling or Heating mode, depending on current configuration.

When the chiller is in **Heating mode**, the control utilises the boiler to satisfy the heating demand. For heat pumps, the boiler is used when mechanical heating is impossible or insufficient. Additionally, when the outside air temperature is very low, electric heaters can be used as a form of supplemental heating (heat pumps only).

When **Cooling mode** is selected, the unit will operate in the Cooling mode and, as a result, the boiler or electric heating will not be activated.

The unit may also "operate" in Standby mode which means that it is neither cooling nor heating. If the unit is in **Standby mode**, it does not cool or heat and compressors are stopped. The pump is running with no mechanical cooling or heating unless configured otherwise. The pump may be stopped depending on pumps configuration (PUMPCONF – Pump Configuration).

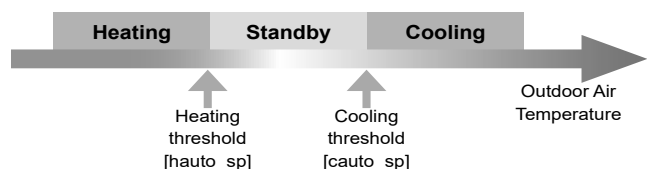

8 - STANDARD CONTROL OPERATIONS AND OPTIONS

8.2.1 Operating mode - control

The operating mode, i.e. cooling or heating, is determined based on the following parameters:

- **Unit on/off status [status]:** Unit running status.
- **Control type [ctrl_typ]:** Local, Remote or Network.
- **Local heat/cool selection [hc_sel]:** Heat/Cool selection when the unit is running in Local mode.
- **Remote heat/cool selection [onsw_cr]:** Heat/Cool selection when the unit is running in Remote mode.
- **Network heat/cool selection [HC_SEL]:** Heat/Cool selection when the unit is running in Network mode.
- **Outdoor air temperature [OAT]:** Heat/Cool setpoint selection when the automatic changeover has been enabled.

8.2.2 Heating / Cooling selection

Heating/Cooling selection applies to chillers with a boiler and heat pumps. Heating/Cooling selection can be controlled in various ways, depending on the active operating type. By default, the cooling mode is selected.

Heating/Cooling selection can be determined:

- Locally at the unit using the HC_SEL item in the GENUNIT menu.
- Remotely via the heating/cooling selection contact, if the unit is in the Remote mode.
- Via a network command if the unit is in the Network mode.

Heating/Cooling mode can be set manually by the user or automatically by the control. When heating/cooling is automatic, the outdoor air temperature (OAT) determines the heat/cool/standby changeover (see the SETPOINT menu for cooling and heating mode changeover thresholds). The automatic changeover is optional and requires user configuration (GENUNIT – General Parameters).

Control type	Heat / Cool (Local)	Heat / Cool (Remote)	Heat / Cool (Network)	Outdoor Air Temperature	Operating mode
local	cool	-	-	-	cooling
local	heat	-	-	-	heating
local	auto*	-	-	> cauto_sp + 1	cooling
local	auto*	-	-	< hauto_sp - 1	heating
local	auto*	-	-	hauto_sp + 1 < oat < cauto_sp - 1	standby
remote	-	on_cool	-	-	cooling
remote	-	on_heat	-	-	heating
remote	-	on_auto	-	> cauto_sp + 1	cooling
remote	-	on_auto	-	< hauto_sp - 1	heating
remote	-	on_auto	-	hauto_sp + 1 < oat < cauto_sp - 1	standby
network	-	-	cool	-	cooling
network	-	-	heat	-	heating
network	-	-	auto*	> cauto_sp + 1	cooling
network	-	-	auto*	< hauto_sp - 1	heating
network	-	-	auto*	hauto_sp + 1 < oat < cauto_sp - 1	standby

* If auto changeover has been selected through user configuration; otherwise, by default set to "cooling".

Legend

cauto_sp = cooling changeover setpoint (SETPOINT menu)
 hauto_sp = heating changeover setpoint (SETPOINT menu)
 oat = outdoor air temperature

8.3 Supplementary heating

AQUACIAT^{POWER} LD chillers may be fitted with a boiler that allows the unit to run in heating mode if required. The boiler is active only when the unit is in Heating mode.

AQUACIAT^{POWER} ILD heat pumps may be fitted with a boiler or electric heaters which are used as heating replacement when mechanical heating is not possible due to low outdoor air temperature. Electric heating can be turned on to satisfy the heating demand when mechanical heating is insufficient.

8.3.1 Boiler control

Boiler is activated when the outside air temperature is below the user-configured boiler outdoor temperature threshold which is by default set to -10°C (Boiler OAT Threshold in the BACKUP menu).

8.3.2 Electric heating control

Electric heating stages can be activated as additional heating when OAT is below the user-configured electric heating OAT threshold which is by default set to 5°C (Elec Stage OAT Threshold in the BACKUP menu).

Electric heating is allowed when:

- Unit is running at 100% capacity.
- Electric pull-down time elapsed.
- OAT is below the OAT threshold.

IMPORTANT: Please note that electric heating is not allowed when the demand limit is active on the unit.

8.4 Water pumps control

The CONNECT TOUCH control can manage one or two water exchanger pumps, determining the state of each pump as well as its speed. The pump can be turned on when configured and when the unit is running (Pumps Sequence in the PUMPCONF menu).

The pump is turned off when the unit is shut down due to an alarm, unless the fault is a frost protection error. The pump can be started in particular operating conditions when the water exchanger heater is active.

If the pump has failed and another pump is available, the unit is stopped and started again with the second pump. If there is no pump available, the unit shuts down.

Please remember that the configuration of pump(s) may differ depending on the number and type of pumps that are available for the specific unit (1 or 2 pumps / single-speed or variable-speed pumps).

8.4.1 Variable speed pumps control

AQUACIAT^{POWER} LD chillers as well as ILD heat pumps may be fitted with one or two variable speed pumps.

Variable speed pumps give the possibility of saving the pumping energy cost, providing precise water flow control and improving the overall performance of the system. The frequency inverter continuously regulates the flow rate to minimise the pump power consumption at full load and part load.

Water flow management methods are as follows:

- 1) Fixed speed control (the control ensures a constant pump speed based on compressor capacity).

8 - STANDARD CONTROL OPERATIONS AND OPTIONS

- 2) Water flow control based on constant water delta pressure (the control continuously acts on the pump speed to ensure a constant delta pressure).
- 3) Water flow control based on constant delta T on the water exchanger.
 - For units with "External Variable Speed Pump" (customer pump), the control system will use a constant temperature differential (constant delta T) only for flow monitoring. The pump is controlled by a 0-10V signal (AO, CIOB/SIOB board).

Fixed speed pumps can be either low or high pressure, whereas variable speed pumps are always high pressure pumps.

8.4.2 Configuring pumps

The CONNECT TOUCH can control fixed speed and variable speed pumps as well as customer pumps. Note that variable speed pumps can be configured as fixed speed pumps.

Basic pump configuration can be performed via the Configuration menu (PUMPCONF – Pump Configuration). Remember that only logged-in users may access the menu. The unit must be stopped.

IMPORTANT: Please note that the speed of the pump can be configured only by service technicians.

To set pumps sequence

1. Navigate to the Configuration menu (logged-in users only).
2. Select **Pump Configuration** (PUMPCONF).
3. Set Pumps Sequence [pump_seq].

Pumps Sequence [pump_seq]	
0	No pump
1	One pump only
2	Two pumps auto
3	Pump#1 Manual
4	Pump#2 Manual

8.4.3 Setting pumps automatically

If there are two pumps in the system controlled by the CONNECT TOUCH control, then the "pump reversing" functionality can be used. When the pump reversing option is selected, then the control balances the pump run time to match the configured pump changeover delay. In case the delay has elapsed, the pump reversing function is activated.

To set pumps automatic rotation delay

1. Navigate to the Configuration menu (logged-in users only).
2. Select **Pump Configuration** (PUMPCONF).
3. Set Pump Auto Rotation Delay [pump_del].

Pump Auto Rotation Delay [pump_del]	
24 to 3000h	48h

8.4.4 Setting customer pumps

Units with customer pumps are fitted with the flow switch, allowing for the water flow control.

Customer pumps have the following configurations possible:

Pump(s) available	[pump_seq]	Description
No pump	0	No pump
One single speed pump	1	One pump only
Two single speed pumps	2	Two pumps automatic
	3	Pump #1 manual
	4	Pump #2 manual

8.4.5 Setting pump protections

To mitigate the risk of freezing the water exchanger when the outside air temperature is low, the CONNECT TOUCH control provides a means to automatically start the pump each day at 14:00 for 2 seconds when the unit is "Off" (especially useful when the unit is stopped for a long time, e.g. during the winter season).

For units fitted with two pumps, the first pump is started on even days and the second pump is started on odd days. Starting the pump periodically for a few seconds extends the lifetime of the pump bearings and the tightness of the pump seal. This periodical pump quick start can be selected via the Configuration menu.

To set periodical pump quick start

1. Navigate to the Configuration menu (logged-in users only).
2. Select **Pump Configuration** (PUMPCONF).
3. Set Pump Sticking Protection [pump_per].

Pump Sticking Protection [pump_per]	
No/Yes	Yes

8.4.6 Setting ECO pump mode

When the unit is in Standby mode (heating or cooling demand is satisfied), the CONNECT TOUCH control may be configured to stop the pump periodically in order to save energy.

This option can be configured only by service technicians.

To verify the Eco Pump configuration

1. Navigate to the Main menu.
2. Select **Miscellaneous Status** (MSC_STAT).
3. Verify Eco Pump Mode Active [m_ecopmp].

Eco Pump Mode Active [m_ecopmp]
No/Yes

8.5 Hydronic kit option

The hydronic kit option allows for continuous monitoring of the water flow rate.

The hydronic kit provides the option to measure the following parameters:

- Inlet and Outlet water pressure.
- Water exchanger flow rate.

How is the water flow rate measured?

The water flow rate measurement is based on the calculation that takes into account the pressure difference between the Inlet water pressure and the Outlet water pressure as well as the pressure drop curves.

Hydronic kit option + variable speed pumps

In the case of units fitted with variable speed pumps, the CONNECT TOUCH control adjusts the pump speed automatically in order to make sure that the water flow rate is maintained at the correct level.

Depending on the selected configuration, the water flow control can be based on compressor usage, constant delta pressure or constant temperature difference.

8 - STANDARD CONTROL OPERATIONS AND OPTIONS

8.6 Control point

The control point represents the water temperature that the unit must produce. The required capacity can be decreased depending on the unit load operating conditions.

Control point = Active setpoint + Reset

The control point is based on the active setpoint and the reset calculation. The forced value can be used instead of any other setpoint calculation only when the unit is in the Network operating type.

8.6.1 Active setpoint

Two heating setpoints and three cooling setpoints can be selected. The third cooling setpoint is used for ice storage during unoccupied periods.

Depending on the current operation type, the active setpoint can be selected using one of the following methods:

- Manually
 - Via the Main menu (GENUNIT - General Parameters)
 - With the volt-free user contacts
 - Network commands
- Automatically
 - Setpoint Time Schedule is used (schedule 2)

The following tables provide the overview of possible setpoint selections, where the selected setpoint depends on the following parameters:

- **Control operating type:** Local, Remote, Network
- **Mode:** Cooling or Heating
- **Setpoint select parameter:** The Setpoint Select parameter in the General Parameters menu allows the user to select the active setpoint when operating in the Local control operating type [hc_sel in GENUNIT menu]
- **Ice configuration:** Ice production mode configuration [ice_cnfg in GENCONF menu]
- **Ice done contact status:** Available on EMM SIOB/CIOB board
- **Setpoint switch status:** Remote Setpoint switch parameter in the Inputs menu
- **Schedule 2 status:** Schedule configuration

LOCAL OPERATING TYPE						
Mode	Setpoint selection	Ice configuration	Ice done contact	Setpoint switch	Schedule 2 status	Active setpoint
cooling	sp-1	-	*	*	-	Cooling setpoint 1
cooling	sp-2	-	*	*	-	Cooling setpoint 2
cooling	(*)	enable	open	closed	-	Ice setpoint
cooling	(*)	enable	closed	closed	-	Cooling setpoint 2
cooling	auto	-	*	*	occupied	Cooling setpoint 1
cooling	auto	-	*	*	unoccupied	Cooling setpoint 2
cooling	auto	enable	open	*	unoccupied	Ice setpoint
cooling	auto	enable	closed	*	unoccupied	Cooling setpoint 2
heating	sp-1	-	*	*	-	Heating setpoint 1
heating	sp-2	-	*	*	-	Heating setpoint 2
heating	auto	-	*	*	occupied	Heating setpoint 1
heating	auto	-	*	*	unoccupied	Heating setpoint 2

REMOTE OPERATING TYPE						
Mode	Setpoint selection	Ice configuration	Ice done contact	Setpoint switch	Schedule 2 status	Active setpoint
cooling	-	-	*	open	-	Cooling setpoint 1
cooling	-	-	*	closed	-	Cooling setpoint 2
cooling	-	enable	open	closed	-	Ice setpoint
cooling	-	enable	closed	closed	-	Cooling setpoint 2
heating	-	-	*	open	-	Heating setpoint 1
heating	-	-	*	closed	-	Heating setpoint 2

NETWORK OPERATING TYPE						
Mode	Setpoint selection	Ice configuration	Ice done contact	Setpoint switch	Schedule 2 status	Active setpoint
cooling	-	-	*	*	occupied	Cooling setpoint 1
cooling	-	-	*	*	unoccupied	Cooling setpoint 2
heating	-	-	*	*	occupied	Heating setpoint 1
heating	-	-	*	*	unoccupied	Heating setpoint 2

* any configuration

- default configuration

8 - STANDARD CONTROL OPERATIONS AND OPTIONS

8.6.2 Reset calculation

Reset means that the active setpoint is modified so that less machine capacity is required in order to satisfy the current demand.

In the cooling mode the setpoint is increased, whereas in the heating mode it is usually decreased.

The reset can be based on the following factors (sources):

- OAT that gives the measure of the load trends for the building.
- Return water temperature (ΔT provides the average building load).
- Space temperature (Energy Management Module).
- Dedicated 4-20 mA input (Energy Management Module).

The reset source as well as reset parameters can be configured via the CONNECT TOUCH user interface (RESETCFG – Reset Configuration).

In response to a drop in the reset source, e.g. OAT, the cooling setpoint is normally reset upwards to optimise the unit performance.

The reset value is determined by linear interpolation based on the following parameters:

- A reference at which the reset is zero = no reset value
- A reference at which the reset is maximum = full reset value
- The maximum reset value

Reset example in Cooling mode:

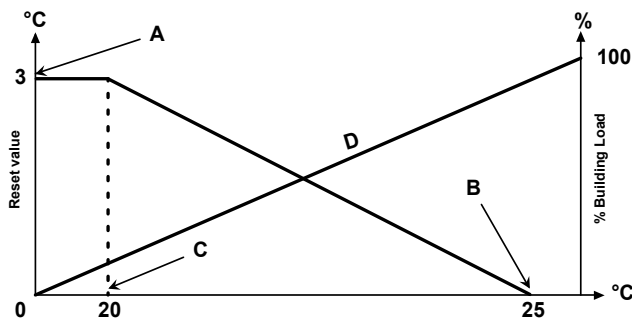

20	Reset based on OAT	25
0	Reset based on delta T	3
4	Reset based on analog input	20
no_reset	Selection	full_reset

Legend:

- A: Maximum reset value
- B: Reference for zero reset
- C: Reference for maximum reset
- D: Building load

8.7 Capacity limitation

The CONNECT TOUCH control allows for the constant control of the unit capacity. It is possible thanks to setting the unit's maximum allowable capacity.

How to understand "capacity limitation"?

Capacity limitation is used to determine the maximum unit's capacity. Capacity limitation is expressed in percentage, where a limit value of 100% means that the unit may run with its full capacity (no limitation is required).

The unit capacity can be limited as follows:

- By means of user-controlled volt-free contacts. The unit capacity can never exceed the setpoint limit activated by these contacts.
- By lag limit [LAG_LIM] set by the Master unit in the master/slave assembly. If the unit is not in the master/slave assembly, then the lag limit value is equal to 100%.
- By night mode limitation control. The demand limit value in the night mode is selectable if the value is below the selected capacity limit.

To set limit setpoints

1. Navigate to the Main menu.
2. Select **Setpoint Configuration** (SETPOINT).
3. Set Switch Limit Setpoint 1 / 2 / 3 [lim_sp1 / 2 / 3].

Switch Limit Setpoint 1 / 2 / 3 [lim_sp1 / 2 / 3]

0 to 100% 100%

To verify lag limit set by the master unit

1. Navigate to the Main menu.
2. Select **General Parameters** (GENUNIT).
3. Verify Lag Capacity Limit Value [LAG_LIM].

Lag Capacity Limit Value [LAG_LIM]

0 to 100% 100%

To set the night mode limit

1. Navigate to the Configuration menu (logged-in users only).
2. Select **General Configuration** (GENCONF).
3. Set Night Capacity Limit [nh_limit].

Night Capacity Limit [nh_limit]

0 to 100% 100%

Active demand limit

Based on the limit source, the active demand limit value [DEM_LIM] is set to the lowest possible value. The DEM_LIM parameter can be forced by Network.

To verify active demand limit value

1. Navigate to the Main menu.
2. Select **General Parameters** (GENUNIT).
3. Verify Active Demand Limit Val [DEM_LIM].

Active Demand Limit Val [DEM_LIM]

0 to 100% -

8 - STANDARD CONTROL OPERATIONS AND OPTIONS

8.8 Controlling capacity

The control adjusts the capacity to keep the water exchanger temperature at its setpoint. Compressors are started and stopped in a sequence designed to equalize the number of starts (value weighted by their operating type).

8.8.1 Circuit loading sequence

The function determines in which order the circuit capacity is changed. Compressor loading is managed by starting/stopping compressors. Two types of sequencing, i.e. balanced and staged loading sequence, are available and can be configured by the user via the user interface.

Balanced loading sequence: The control maintains equal capacity between all circuits as the machine loads and unloads. Balanced loading sequence is the default sequence employed by the control.

Staged loading sequence: The control loads the lead circuit completely before the lag circuit is started. When the load is decreasing, the lag circuit is unloaded first. Staged loading sequence is active when one of the circuits is shut down due to its failure; the circuit is in capacity override mode; or the remaining circuits are shut down or fully charged.

To set the circuit loading sequence

1. Navigate to the Configuration menu (logged-in users only).
2. Select **General Configuration** (GENCONF).
3. Set Staged Loading Sequence [seq_typ].

Staged Loading Sequence [seq_typ]	
No/Yes	No (staged loading NOT active)

8.8.2 Capacity for multi-circuit units

For units with more than one circuit, the lead/lag function determines which circuit is the lead circuit and which circuit is the lag circuit. This function controls the start/stop sequence of two refrigeration circuits called circuit A and circuit B.

The circuit authorised to start first is the lead circuit. Lead circuit is used first for capacity increases and at the same time should be decreased first when decreasing capacity. The lead/lag circuits can be selected manually or automatically.

- **Manual lead/lag circuit determination:** Circuit A or circuit B selected as the lead circuit. The selected circuit takes priority over another circuit.
- **Automatic lead/lag circuit determination:** The control system determines the lead circuit to equalise the operating time of each circuit (value weighted by the number of start-ups of each circuit). As a result, the circuit with the lowest number of operating hours always starts first.

To set circuit priority (manual or automatic selection)

1. Navigate to the Configuration menu (logged-in users only).
2. Select **General Configuration** (GENCONF).
3. Set Cir Priority Sequence [prio_cir].

Cir Priority Sequence [prio_cir]	
0	Auto
1	Circuit A lead
2	Circuit B lead

8.9 Night mode

Night mode allows users to configure the unit to operate with specific parameters in a specific time period, e.g. at night.

If the night mode is set, then during the night period:

- The unit capacity is limited.
- In order to reduce the noise level, the number of fans allowed to operate is restricted (cooling mode only).

The night period is defined by a start time and an end time that are the same for each day of the week. The night mode settings as well as the maximum capacity value can be set by logged-in users only.

To set circuit priority

1. Navigate to the Configuration menu (logged-in users only).
2. Select **General Configuration** (GENCONF).
3. Set parameters corresponding to the night mode.

Night Mode Start Hour [nh_start]	
00:00 to 24:00	
Night Mode End Hour [nh_end]	
00:00 to 24:00	
Night Capacity Limit [nh_limit]	
0 to 100%	100%

8.10 Controlling the coil pressure

The coil pressure of each circuit is managed by four fans maximum. AQUACIAT^{POWER} LD series and ILD series units may be fitted with variable speed fans that provide higher part load efficiency and reduced noise level.

In cooling mode, the condensing pressure is controlled independently in each circuit based on the saturated condensing temperature. The control permanently adjusts its setpoint to guarantee optimal performance and ensure anti-short-cycle protection of the fans.

In heating mode, the evaporating pressure is controlled independently on each circuit based on the saturated suction temperature. The control permanently adjusts its setpoint to guarantee optimal performance, delay and limit frost accumulation on coils.

8 - STANDARD CONTROL OPERATIONS AND OPTIONS

8.11 Setting holidays

The control allows the user to define 16 holiday periods. Each holiday period is defined by three parameters, i.e. the month, the start day, and the duration of the holiday period.

During the holiday period, depending on periods defined as holidays, the controller will be either in occupied or unoccupied mode. Holiday periods can be modified by logged-in users only.

To modify holiday periods

1. Navigate to the Configuration menu (logged-in users only).
2. Select **Holiday Menu** (HOLIDAY).
3. Choose the holiday period, e.g. HOLDY_01.
4. Set Holiday Start Month [HOL_MON], Start Day [HOL_DAY], Duration (days) [HOL_LEN].

Holiday Start Month [HOL_MON]	
0-12	0
Start Day [HOL_DAY]	
0-31	0
Duration (days) [HOL_LEN]	
0-99	0

8.12 Dry cooler – free cooling option

AQUACIAT^{POWER} LD chillers and AQUACIAT^{POWER} ILD heat pumps may be fitted with a dry cooler that enables power consumption reduction which amounts to energy and cost savings.

The installation of a dry cooler allows for "free cooling" – a method of using low outdoor air temperature as an aid to chilling water that is later used in the air-conditioning system. The system is the most effective when the outdoor air temperature is below 0°C (32°F).

This "dry cooler free cooling" mode is enabled when the outside air temperature ("OAT Free Cooling") is below the water loop temperature and the service-configured threshold parameter.

NOTE: Dry cooler water loop temperature and free cooling OAT measured by the control are read-only values that can be verified in the DC Free Cooling Status menu (DCFC_STA).

The control distinguishes between two types of fan control for a dry cooler free cooling option, where the first one embraces the use of fan staging and the second one that includes the use of variable speed fan. Mixed configuration can also be used (fixed and variable-speed fan control at the same time).

Dry cooler free cooling is normally stopped when the outside air temperature ("OAT Free Cooling") is above the water loop temperature and the service-configured threshold parameter. However, if it turns out that the cooling power of the dry cooler is not enough in order to reach the cooling setpoint, then the mechanical cooling will be started (when FC capacity is at 100%, then mechanical cooling can be started).

8.13 Energy Management Module

The CONNECT TOUCH control may be interconnected with the Energy Management Module (EMM) used to control the level of energy consumption, providing users with information such as the current unit status, compressors operating status, etc.

8.14 Heat recovery option (desuperheater)

Heat recovery is a method of using energy that would normally leave the system in the form of the waste heat released into the air.

Thanks to the concept of heat recovery, AQUACIAT^{POWER} ILD heat pumps can produce hot water using the recycled heat. Such a solution does not only allow for decreasing the energy consumption expenses but it also proves to be environmentally friendly. By recovering heat from the cooling cycle, the CONNECT TOUCH control system can maximise the unit efficiency and provide a large amount of hot water to the building system.

AQUACIAT^{POWER} LD chillers and AQUACIAT^{POWER} ILD heat pumps may be fitted with a desuperheater that allows for better energy management by providing partial heat reclaim functionality.

Desuperheater (heat exchanger) is mounted between the compressor and air-cooled condenser. The desuperheater is used to extract the high pressure, high temperature heat from the refrigerant to "desuperheat" it to a lower pressure refrigerant. The heat that is obtained in this process can be used for warming the water (up to 80°C). Please note that the vapour that goes into the desuperheater is not fully condensed; therefore, the refrigerant is channelled to a separate heat exchanger ("condenser") where the condensing process occurs.

To set the minimum desuperheat temperature

1. Navigate to the Main menu.
2. Select **Setpoint Configuration** (SETPOINT).
3. Set Desuperheat Min SCT [min_sct].

Desuperheat Min SCT [min_sct]	
24 to 50°C	40°C
75 to 122°F	104°F

8 - STANDARD CONTROL OPERATIONS AND OPTIONS

8.15 Heat Reclaim (option 50)

Heat reclaim is a method of using energy that normally leaves the system in the form of the waste heat at the condenser site. Chillers with the heat reclaim option are fitted with two condensers (air-cooled condenser which is set as standard and water-cooled condenser which is used for heat reclaim).

Adding the heat reclaim condenser (BPHE) to the unit may significantly reduce unit energy consumption with maximized chiller plant efficiency.

Heat reclaim chiller generates high pressure refrigerant within the condenser that can be used to produce higher temperature condenser water. When the Heat Reclaim mode is active, the HR condenser will generate hot water to be used in the customer hot water system.

The chiller can switch to the Heat Reclaim mode when:

- HR option has been set on ("Reclaim selection" is set to "yes" in RECLAIM table or the HR switch is closed in Remote mode)
- HR control water temperature is below the Heat Reclaim Control Point (set in RECLAIM table) with an offset of 0.5K.

The Heat Reclaim 3-way valve controls the hot water loop based on a PID algorithm. If needed, fans' speed will be adapted to reach the Heat Reclaim setpoint. When the "Eco" mode is enabled, fans will not be used, which saves some energy.

Please note that the 3-way valve can be replaced with the variable-speed pump, also controlled with the PID algorithm. However, in that case, the Heat Reclaim control can be based only on the entering water temperature.

If in the air-cooled mode the leaving water temperature (HR_LWT) is above 75°C (167°F), the 3-way valve or the variable-speed pump controlled by the PID algorithm will ensure minimum water flow on heat exchangers and prevent water boiling. It is therefore necessary to permanently guarantee the use or evacuation of the heat transferred to the hydraulic circuit.

When Heat Recovery is not used and the outside air temperature is low, the control provides anti-freeze protection by opening the 3-way valve to its minimum position or running the variable-speed pump at its minimum speed. This ensures minimum water flow in the heat exchanger.

For HR chillers running on water, the controller may activate the optional HR condenser heater (option 41C) to provide anti-freeze protection when necessary.

Customer water loop with a 3-way valve

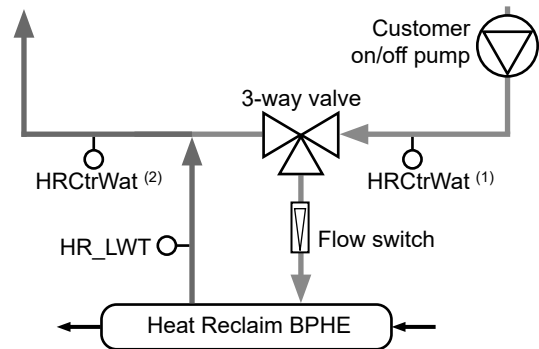

Legend:

- HR_LWT: Heat Reclaim Leaving Water Temperature sensor (water temperature measured on the BPHE condenser outlet).
- HRCtrWat: Heat Reclaim Control Water Temperature sensor (water temperature measured before the 3-way valve OR after the 3-way valve on the customer side).
 - If the sensor is located before the 3-way valve [HRCtrWat (1)], then "HR Control on EWT ?" in HR_CFG table is set to "yes".
 - If the sensor is located after the 3-way valve [HRCtrWat (2)], then "HR Control on EWT ?" in HR_CFG table is set to "no".
- Flow Switch: Heat reclaim water flow status (used to detect if the water flows in the BPHE condenser)

Customer water loop with a variable-speed pump

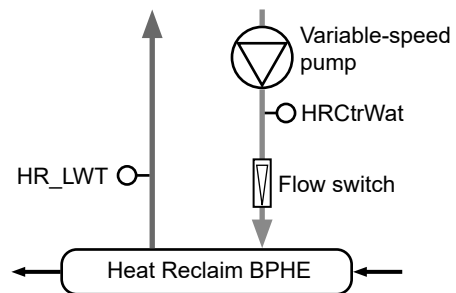

Legend:

- HR_LWT: Heat Reclaim Leaving Water Temperature sensor (water temperature measured on the BPHE condenser outlet).
- HRCtrWat: Heat Reclaim Control Water Temperature sensor (water temperature measured after the variable-speed pump on the customer side).
 - "HR Control on EWT ?" in HR_CFG table is set to "yes".
- Flow Switch: Heat reclaim water flow status (used to detect if the water flows in the BPHE condenser).

8 - STANDARD CONTROL OPERATIONS AND OPTIONS

8.16 Free Cooling (option 305A/305B/305C)

When the OAT is low enough compared to the control setpoint, the controller allows the hydraulic Free Cooling (FC) system to cool down the customer loop by circulating glycol-water mixture in FC coils which are located in parallel to MCHE refrigerant coils.

Instead of mechanical cooling, the system is using low temperature ambient air to cool down the process water and satisfy the cooling demand. This enables the complete shutdown of compressors and results in energy saving.

FC coils integrated with refrigerant coils

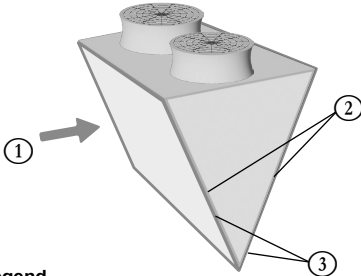

Legend

1. Air flow (low temperature ambient air)
2. MCH coils
3. FC coils

The system comes with three Free Cooling options:

- Option 305A: Total Hydraulic Free Cooling (FC coils are mounted on each coil of two circuits).
- Option 305B: Partial Hydraulic Free Cooling (FC coils are mounted on coils of one circuit only).
- Option 305C: Total Hydraulic Free Cooling / Glycol-Free (FC coils are mounted on coils of two circuits).

8.16.1 Units with option 305A / 305B

Option 305A/305B is used in systems where the process water is the glycol-water mixture (fluid type = brine).

- Two 2-way valves are used to disable or enable the FC subset. The state of the valves depends on whether the Free Cooling mode is active or not.

FC mode	Evaporator valve	Coil valve
No	Open	Close
Yes	Close	Open

When the Free Cooling mode is active, the process water is going directly through FC coils and then passing through the evaporator before returning to the building.

8.16.2 Units with option 305C

Option 305C is used in systems where glycol is not permitted, i.e. process water is 'pure water' (fluid type = water).

- This option comes with an additional brazed plate heat exchanger (BPHE) connected to FC coils with the glycol-water mixture running through them ("glycol-water loop"). This intermediate heat exchanger is also referred to as "Glycol-Free BPHE" as it does not require adding glycol to the process water. The glycol-water solution is only used on the Free Cooling side.

Glycol-Free BPHE

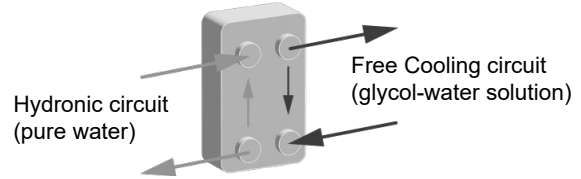

For chillers with option 305C, the process water is normally passing through the Glycol-Free BPHE and then going into the evaporator before returning to the building.

In the glycol-water loop:

- There is a fixed speed pump ("FC coil pump") located at the output of the Glycol-Free BPHE.

The FC coil pump can operate in one of the following modes:

- Free Cooling: The pump is "on".
- Anti-sticking protection: When the FC coil pump is stopped, the controller will start this pump each day at 14:00 for 25 seconds. Starting the pump periodically increases the lifetime of pump bearings and the tightness of the pump seal. This functionality requires service configuration (enabled by default).

- The heater is used to protect the Glycol-Free BPHE against freezing when the chiller is stopped and the outside air temperature is very low (freeze protection).

8.16.3 Free Cooling modes

Free Cooling is activated when the outside air temperature drops 2°C below the chiller EWT and the system has been already operating in Cooling mode for at least 10 minutes.

The circuit of the unit mounted with FC coils can operate in the following modes:

- Mechanical Cooling (MC) mode (with compressors activated only): When the FC conditions cannot be met.
- Controlled Free Cooling mode (compressors stopped on both circuits): When the FC conditions are met and sufficient to achieve the control setpoint.
- Full Free Cooling mode (compressors stopped on one circuit but not on the other): When the FC conditions are met and the other circuit has already some compressors ON. The objective is to take advantage of the total FC power of the circuit to accelerate the unloading of the compressors of the other circuit.
- Mixed mode (MC and FC at the same time): When the FC conditions are met but not sufficient enough to achieve the requested setpoint.

To verify the cooling mode

1. Navigate to the Main menu.
2. Select *Hydraulic Free Cooling* (HYD_FC).
3. Verify *Mode of Circuit A (B)* [modeCirA / modeCirB].

Mode of Circuit A [modeCirA] / Mode of Circuit B [modeCirB]

0	Mechanical Cooling
1	Mixed Cooling
2	Controlled Free Cooling
3	Full Free Cooling

8 - STANDARD CONTROL OPERATIONS AND OPTIONS

8.17 Defrost cycle (heat pumps only)

When the outside air temperature is low and the ambient humidity is high, the probability of frost forming on the surface of the outdoor coil increases. The frost covering the outdoor coil may decrease the air flow across the coil and lead to lower performance of the unit. To remove the frost from the coil, the control initiates the defrost cycle when necessary (defrost mode acts as Cooling mode).

8.17.1 Standard defrost

During the defrost cycle, the circuit is forced into the cooling mode. The heat (energy) is extracted from the water circuit by using compressors and reversing the 4-way valve. The defrost cycle lasts until the end of defrost temperature is achieved.

8.17.2 Free defrost

Free defrost is used in order to eliminate a respectively small amount of frost that has formed on the surface of the coil. Contrary to the standard defrost session, in the case of the free defrost session the heat (energy) is absorbed from the air. When running the free defrost operation, fans are activated and all compressors are turned off. The free defrost is most efficient when current heating demand is below the heating capacity delivered by the unit and the outside air temperature is above 1°C.

IMPORTANT: In the case of a large amount of frost covering the coil, the standard defrost cycle will be started.

8.18 Master/Slave control

The CONNECT TOUCH control system optimises the management of two units linked by the proprietary protocol network.

The unit configured as the Master is a control point for the master/slave assembly. The Master unit can be controlled locally, remotely or by network commands, while the Slave unit remains in Network mode.

All control commands sent to the master/slave assembly (start/stop, setpoint selection, heating/cooling, operating mode, load shedding, etc.) are handled by the unit which is configured as the master. The commands are transmitted automatically to the slave unit. For example, if the master chiller is turned off while the master/slave function is active, then the slave unit will be stopped.

In the event of a communication failure (between the two units), each unit will return to an autonomous operating mode until the detected fault is cleared. If the Master unit is stopped due to a detected alarm, then the Slave unit is authorised to start.

IMPORTANT: Master/Slave assembly can be configured only by service technicians.

8.19 BACnet IP / BACnet MS/TP option (option 149)

The BACnet IP / BACnet MS/TP communication protocol can be used to communicate with other controllers available in the same BMS.

NOTE: This option requires the Software Activation Key.

8.20 Brine option (option 6)

AQUACIAT^{POWER} LD units offer a cooler fluid type selection, including standard water fluid as well as the optional brine fluid, i.e. low brine (option 6). The brine option is commonly used for low temperature applications. AQUACIAT^{POWER} ILD heat pumps can use water only.

NOTE: This option requires the Software Activation Key.

8.21 Refrigerant gas leak detection option

The control permits refrigerant leak detection. Two additional sensors that detect the refrigerant concentration in the air must be installed on the unit.

If one of these sensors detects an abnormal refrigerant level for more than one hour (timer set by service technicians), the alarm will be triggered, but the unit will continue to operate.

8.22 Modbus (option 149B)

The Modbus communication protocol is used by the building management system or the programmable controllers to communicate with the CONNECT TOUCH control.

NOTE: Modbus option is provided as standard.

8.23 Cooling floor optimization (option 119C)

Heat pumps with option 119C enabled will operate with lower than standard capacity limits in Cooling mode in order to save energy.

NOTE: This option requires the Software Activation Key.

8 - STANDARD CONTROL OPERATIONS AND OPTIONS

8.24 Software Activation Key(s)

AQUACIAT^{POWER} units with CONNECT TOUCH offer some additional options which require Software Activation Keys:

- **Cooler fluid type:**
 - Low brine (option 6)
- **BACnet** communication (option 149)
- **Modbus** communication (option 149B) (software activation key automatically provided)
- **Cooling Floor Optimization** (option 119C)
- **Fast capacity recovery** (option 295+)

These software-protected options can be factory-installed or installed on-site by the service technician or the customer.

Each option requires an individual software activation key.

To obtain the Software Activation Key, please contact your local Service representative.

8.24.1 Software options

The list of available software activation keys can be verified via the Main menu.

To verify available software options

1. Go to the Main menu.
2. Select *Software Options* (OPT_STA).
The menu can be accessed when logged in at user access level.
 - If the status of the option is set to “yes”, it means that the Software Activation Key for this option is installed.

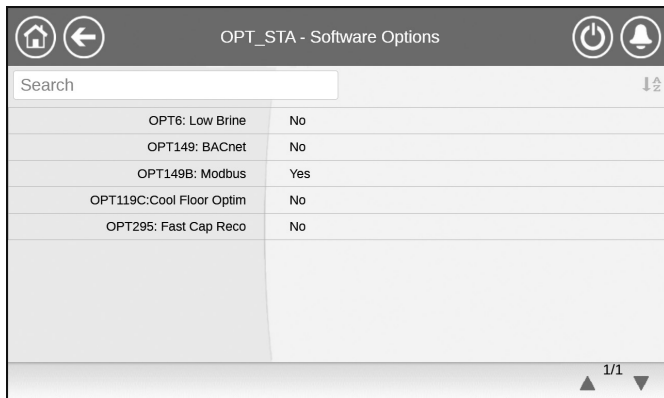

Option	Status
OPT6: Low Brine	No
OPT149: BACnet	No
OPT149B: Modbus	Yes
OPT119C: Cool Floor Optim	No
OPT295: Fast Cap Reco	No

IMPORTANT: In case the controller is replaced, the Software Activation Key must be installed again. See also section "8.24.2 Replacement mode".

8.24.2 Replacement mode

To enable the use of software options until the Software Activation Key(s) is(are) installed, the Replacement mode will be activated.

- Software options will be unlocked for a limited period of time (7 days since the first start of the compressor).
- Only options that have been installed on the unit before will be active in the Replacement mode. Option status can be verified via the Main menu (OPT_STA – Software Options).
- Alarm 10122 will be triggered. If the Software Activation Key is not provided within 7 days since the first compressor start, the alarm will be reset automatically and software options will be blocked.
- The Replacement mode ends when the Software Activation Key is installed or the period of 7 days elapsed (7 days since the first compressor start).

8.24.3 Software key installation

To install the Software Activation Key via CONNECT TOUCH

1. Go to the Main menu.
2. Navigate to the Configuration menu (logged-in users only).
3. Select *Add Options* (ADD_OPT).
 - When installing the Software Activation Key, please make sure that the unit is stopped.

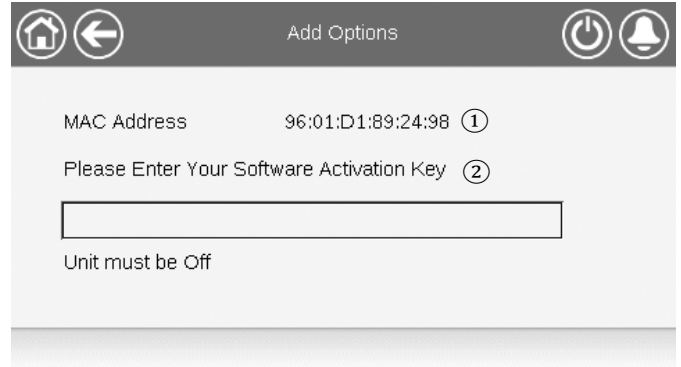

MAC Address 96:01:D1:89:24:98 ①

Please Enter Your Software Activation Key ②

Unit must be Off

Legend:

- ① Controller MAC address
- ② Software Activation Key

4. Enter the **Software Activation Key**.
 - If the Software Key ends with two equality signs (==), then these signs can be omitted. The Key will be accepted.
 - The Software Activation Key is case-sensitive.
5. Once the Software Activation Key is provided in the Keyboard screen, press **OK**.
6. Once the Software Activation Key is validated, the following message will be displayed: **“Software Activation Key Added”**.
7. The parameter connected with the activated functionality is set automatically and the control system will also be rebooted automatically.
 - If the Software Activation Key is incorrect, the following message will be displayed: “Software Activation Key is Invalid”.
 - If the Software Activation Key has been added before, the following message will be displayed: “Key Already Set”.

8.25 Duplex unit (2800R-4000R)

AQUACIAT^{POWER} ILD 2800R-4000R units are delivered as two separate modules connected in parallel.

Two water temperature sensors (one per module) are provided and connected to the water outlet ensuring an optimal control of the water loop. Duplex units are allowed to increase and decrease their own capacity at the same time.

The units are connected via the communication bus. The duplex unit modules, also referred to as the master and the slave module, are configured and addressed at commissioning.

8 - STANDARD CONTROL OPERATIONS AND OPTIONS

8.26 Energy Meter (option 294)

An Energy Meter with a current transformer on the main power supply is used to measure the energy consumption of the unit.

It is every second that the Connect Touch controller reads the energy consumption from the Energy Meter using the Modbus RTU protocol (Connect Touch controller, J8 connector). The controller also sets the time and the date on the Energy Meter. The Energy Meter provides the following measurements:

Name	Point name	Unit
Current per phase	sglPhs_I	A
Active power	p_total	kW
Power factor	pow_fact	-
Total active energy	e_total	kWh
Partial active energy	e_reset	kWh
Maximum active power demand	p_max	kW
Total harmonic distortion	THD	%

The values measured by the Energy Meter are displayed in the Energy Monitoring menu (ENERGY) which also contains smart energy monitoring data (standard "Smart Energy" functionality).

For units equipped with the optional Energy Meter, all "Smart Energy" monitoring data (ENERGY table) related to the electrical power of the unit will be updated with the data coming from the Energy Meter.

If the communication between the controller and the Energy Meter is lost, then an alert will be triggered (alert 59001).

The user can reset the energy consumption readings if needed.

To reset the energy readings

1. Navigate to the Main menu (logged-in users only).
2. Select **Energy Monitoring** (ENERGY).
3. Set *Reset of Energy Counter* [reset_en] to "yes".

Reset of Energy Counter [reset_en]

No/Yes	Yes
--------	-----

8.27 Fast capacity recovery (option 295+)

The "Fast capacity recovery" function is used to restore unit capacity as quickly as possible in the event of a power outage. It also comes with a power supply module that keeps the controller powered in case the power cut occurs.

When the power comes back, the fast capacity recovery mode can be started (MODES, m_fastRe = "yes"). The system modifies compressor loading sequence so that it would bring back the unit capacity to the level prior to the power outage faster than normal.

Please note that "Fast capacity recovery" is activated only if the power outage did not last more than 10 minutes. If the power outage lasted longer than 10 minutes, then the fast capacity recovery mode is not allowed.

NOTE: This option requires the Software Activation Key.

8.29 Phase controller (option 159B)

The Phase Controller is an optional device used to protect the machine by monitoring the main power supply of the unit.

This device has a normally closed relay output. The status of this output is reported in the Inputs table (INPUTS, PH_CTRL).

The Phase Controller can detect the following faults:

- Phase Loss (PL) fault / Phase Sequence (PS) fault
- Under Voltage (UV) fault / Over Voltage (OV) fault
- Three-Phase Voltage Asymmetry (ASYM) fault
- Under Frequency (UF) fault / Over Frequency (OF) fault

In case one of the faults given above is detected, the relay output will open and the alert/alarm will be triggered (see also "phase controller alarm/alert" setting below).

To set the phase controller alarm/alert

1. Navigate to the Configuration menu (logged-in users only).
2. Select **User Configuration** (USERCONF).
3. Set *Phase Controller Action* [PhCtrAct].
 - This parameter is used to define the action taken on the unit in case the fault is detected by the Phase Controller.
 - To prevent unit damage due to unstable power supply conditions, it is recommended to set "Phase Controller Action" to "1" or "2".

Phase Controller Action [PhCtrAct]

0	Alert: No action taken on the unit (default setting)
1	Alarm: The unit shuts down when the alarm is active. The alarm reset is automatic.
2	Alarm: The unit shuts down when the alarm is active. The alarm must be reset manually.

Whenever the "3-Phase Control: Fault detection" alert/alarm is triggered (alarm/alert 10054), this alert/alarm will be active for the minimum time period configured by the user (USERCONF, PCMinTim). By default, it is set to be active for at least 2 minutes and the status of the relay output is ignored during this time period.

8.30 Smart Grid Ready (option 157D)

The Smart Grid Ready ("SG Ready") label of the heat pump allows the energy supplier to access the heat pump and manage its four energy usage control states:

- Lockout state (LOCK)
- Normal operating state (NORMAL)
- Low current surplus state (BOOST)
- High current surplus state (FORCED)

NOTE: The Smart Grid Ready label is valid only in the DACH region (Germany, Austria, Switzerland).

To learn more about the Smart Grid Ready option and Smart Grid operating modes, please refer to Smart Grid Installation Instructions (see Appendix 1).

IMPORTANT: The Smart Grid Ready functionality (option 157D) is not provided as standard. Please contact the Manufacturer to purchase this option.

9 - DIAGNOSTICS

9.1 Control diagnostics





The control system has many fault tracing aid functions, protecting the unit against risks that could result in the failure of the unit.

The CONNECT TOUCH user interface enables the quick display of the unit status:

- The **blinking bell** icon indicates that there is an alarm, but the **unit is still running** (degraded mode).
- The **highlighted bell** icon indicates that the **unit is shut down** due to a detected fault.

The local interface – CONNECT TOUCH Control – gives the user quick access to monitor all unit operating conditions.

If an operating fault is detected, the alarm is triggered. All information regarding the existing alarms (current and past alarms) can be found in the Alarms menu.

Alarms menu	Access	Viewing alarm information			
		Date	Hour	Code	Description
Current Alarms 	Basic	✓	✓		✓
Reset Alarms 	User			✓	
Alarm Historic 	Basic	✓	✓		✓
Major Alarm Historic 	Basic	✓	✓		✓

9.1.1 Displaying current alarms

All currently active alarms can be found in the Current Alarms menu. In addition to the description of the alarm, the control provides information such as date or time that the alarm occurred.

- The Current alarms menu may display up to 10 current alarms.

To access the list of currently active alarms

1. Press the Alarm button in the upper-right part of the screen.
2. Select Current Alarms.
3. The list of active alarms will be displayed.

9.1.2 Resetting alarms

The alarm can be reset either automatically by the control or manually through the CONNECT TOUCH panel display or the web interface (in the Reset Alarms menu).

- The Reset alarms menu displays up to 5 alarm codes which are currently active on the unit.
- Alarms can be reset without stopping the machine.
- Only logged-in users can reset the alarms on the unit.

To reset the alarm manually

1. Press the **Alarm** button in the upper-right part of the screen.
2. Select **Reset Alarms**.
3. Set "Alarm Reset" to Yes.

IMPORTANT: Not all alarms can be reset by the user. Some alarms are reset automatically when operating conditions return to normal.

CAUTION

In the event of a power supply interrupt, the unit restarts automatically without the need for an external command. However, any faults active when the supply is interrupted are saved and may in certain cases prevent a circuit or a unit from restarting.

9.1.3 Reviewing alarm history

Information regarding resolved alarms can be accessed in the Alarm history menu which is divided into 50 recent alarms and 50 recent major alarms.

- **General alarms** are used to indicate pumps failure, transducers faults, network connection problems, etc.
- **Major alarms** are used to indicate process failure.

To access alarms history

1. Press the **Alarm** button in the upper-right part of the screen.
2. Select **Alarm Historic** or **Major Alarm Historic**.

9.2 E-mail notifications

The CONNECT TOUCH control system provides the option to define one or two recipients who receive e-mail notifications each time the new alarm occurs or all existing alarms have been reset.

- Only logged-in users can set and modify e-mail notifications.

To define e-mail recipients

1. Navigate to the Configuration menu and go to **Network Parameters**.
2. Select **Email Configuration**.
3. Add recipients who would receive notifications each time the alarm is triggered.

9 - DIAGNOSTICS

9.3 Alarms description

This section includes all alarms/alerts associated with the operation of the unit as well as optional drives used to provide variable speed fans and variable speed pumps functionalities.

9.3.1 General / Major alarms

The following table includes a list of alarms that might appear on the unit.

JBus code	Code	Alarm description	Reset type	Action taken	Possible cause
Thermistor failure					
1	15001	Water Exchanger Entering Fluid Thermistor Failure	Automatic, if thermistor reading returns to normal	Unit shuts down	Defective thermistor or connection
2	15002	Water Exchanger Leaving Fluid Thermistor Failure	As above	Unit shuts down	As above
3	15003	Circuit A Defrost Thermistor	As above	Cooling mode: Unit continues to operate Heating mode: Circuit A shuts down	As above
4	15004	Circuit B Defrost Thermistor	As above	Cooling mode: Unit continues to operate Heating mode: Circuit B shuts down	As above
5	15010	OAT Thermistor Failure	As above	Unit shuts down	As above
6	15011	Master/Slave Common Leaving Fluid Thermistor	As above	Master/slave operation is disabled and the unit returns to the stand-alone mode	As above
7	15012	Circuit A Suction Gas Thermistor	As above	Circuit A shuts down	As above
8	15013	Circuit B Suction Gas Thermistor	As above	Circuit B shuts down	As above
9	15021	Space Temperature Thermistor	As above	Unit continues to operate, but the setpoint reset is cancelled	As above
10	15008	Reclaim Condenser Entering Thermistor	As above	Heat Recovery mode is stopped, but the chiller continues to operate	As above
11	15009	Reclaim Condenser Leaving Thermistor	As above	Heat Recovery mode is stopped, but the chiller continues to operate	As above
12	15058	FC Evaporator Water Thermistor Failure	As above	No action (alert)	As above
13	15059	FC Glycol Water Thermistor Failure	As above	No action (alert)	As above
16	15046	DC Free Cooling Water Loop Thermistor Failure	Automatic, if thermistor reading returns to normal	Dry cooler free cooling is disabled	Defective thermistor
17	15047	DC Free Cooling Leaving Water Thermistor Failure	As above	No action (alert)	As above
18	15048	DC Free Cooling OAT Sensor Failure	As above	Dry cooler free cooling is disabled	As above
Transducer failure					
19	12001	Circuit A Discharge Transducer	Automatic, if sensor voltage reading returns to normal	Circuit A shuts down	Defective transducer or connection
20	12002	Circuit B Discharge Transducer	As above	Circuit B shuts down	As above
21	12004	Circuit A Suction Transducer	Null voltage: Automatic (three alarms in the last 24 hours) or Manual Impossible value: Manual	Circuit A shuts down	As above
22	12005	Circuit B Suction Transducer	As above	Circuit B shuts down	As above
23	12024	Water Exchanger Entering Fluid Transducer Failure	Automatic, if sensor voltage reading returns to normal	Unit shuts down, water pressure calibration erased	As above
24	12025	Water Exchanger Leaving Fluid Transducer Failure	As above	Unit shuts down, water pressure calibration erased	As above
Communication failure					
27	4901	Loss of communication with Circuit A SIOB/CIOB board	Automatic, if communication is re-established	Unit shuts down	Bus installation fault, communication error
28	4902	Loss of communication with Circuit B SIOB/CIOB board	As above	Unit shuts down	As above
29	4906	Loss of communication with Energy Management SIOB/CIOB board	As above	None	As above

9 - DIAGNOSTICS

JBus code	Code	Alarm description	Reset type	Action taken	Possible cause
30	4501	Loss of communication with Aux Board Number 1 (AUX2 @83, A1-A4 and B1-B4 fixed-speed fans)	As above	Unit shuts down	As above
31	4502	Loss of communication with Aux Board Number 2 (AUX1 @86, Heat Reclaim, 0-10V fan)	As above	Unit shuts down	As above
33	4601	Loss of communication with DC Free Cooling Board	As above	None	As above
34	4701	Loss of communication with VFD Fan Drive 1 Circuit A	As above	Circuit A shuts down	As above
35	4702	Loss of communication with VFD Fan Drive 2 Circuit A	As above	Circuit A shuts down	As above
36	4703	Loss of communication with VFD Fan Drive 1 Circuit B	As above	Circuit B shuts down	As above
37	4704	Loss of communication with VFD Fan Drive 2 Circuit B	As above	Circuit B shuts down	As above
38	4705	Loss of communication with VFD Pump Drive Number 1	As above	Unit is restarted with another pump running. If no pumps are available, the unit shuts down	As above
39	4706	Loss of communication with VFD Pump Drive Number 2	As above	As above	As above
Process failure					
40	10001	Water Exchanger Freeze Protection	Automatic (the first alarm in the last 24 hours) or Manual	Unit shuts down, but the pump continues to run	No water flow, defective thermistor
41	10005	Circuit A Low Saturated Suction Temperature	As above	Unit shuts down	Pressure transducer defective, EXV blocked or lack of refrigerant
42	10006	Circuit B Low Saturated Suction Temperature	As above	Unit shuts down	As above
43	10008	Circuit A High Superheat	Manual	Circuit A shuts down	Pressure transducer defective, temperature sensor defective, EXV blocked or lack of refrigerant
44	10009	Circuit B High Superheat	Manual	Circuit B shuts down	As above
45	10011	Circuit A Low Superheat	Manual	Circuit A shuts down	As above
46	10012	Circuit B Low Superheat	Manual	Circuit B shuts down	As above
47	10014	Customer Interlock Failure	Automatic (the unit is OFF) or Manual	Unit shuts down	Customer interlock input set on
48	10016	Compressor A1 Not Started or Pressure Increase not established	Manual	Compressor A1 shuts down	Compressor breaker or fuse fault, compressor switch open
49	10017	Compressor A2 Not Started or Pressure Increase not established	Manual	Compressor A2 shuts down	As above
50	10018	Compressor A3 Not Started or Pressure Increase not established	Manual	Compressor A3 shuts down	As above
51	10019	Compressor A4 Not Started or Pressure Increase not established	Manual	Compressor A4 shuts down	As above
52	10020	Compressor B1 Not Started or Pressure Increase not established	Manual	Compressor B1 shuts down	As above
53	10021	Compressor B2 Not Started or Pressure Increase not established	Manual	Compressor B2 shuts down	As above
54	10022	Compressor B3 Not Started or Pressure Increase not established	Manual	Compressor B3 shuts down	As above
55	10023	Compressor B4 Not Started or Pressure Increase not established	Manual	Compressor B4 shuts down	As above
56	10028	Electrical Box Fault	Automatic	Unit shuts down	Main power supply fault or high temperature in the control box (units with high ambient temperature option)
57	10030	Master/Slave Communication Failure	As above	Master/slave operation is disabled and the unit returns to the stand-alone mode	As above
58	10031	Unit is in Network emergency stop	Automatic, if emergency stop is deactivated	Unit shuts down	Network emergency stop command
59	10032	Water Pump #1 fault	Manual	Unit is restarted with another pump running. If no pumps are available, the unit shuts down	Evaporator flow switch or evaporator pump fault
60	10033	Water Pump #2 fault	Manual	As above	As above

9 - DIAGNOSTICS

JBus code	Code	Alarm description	Reset type	Action taken	Possible cause
61	10037	Circuit A - Repeated High Discharge Gas Overrides	Automatic (no discharge gas override within 30 min) or Manual (the counter forced to 0)	None	Repetitive capacity decreases
62	10038	Circuit B - Repeated High Discharge Gas Overrides	As above	None	As above
63	10040	Circuit A - Repeated Low Suction Temp Overrides	Manual (the counter forced to 0)	Circuit A shuts down	Repetitive capacity decreases
64	10041	Circuit B - Repeated Low Suction Temp Overrides	As above	Circuit B shuts down	As above
65	10043	Low Entering Water Temperature in Heating	Automatic (EWT returns to normal or Heating mode is disabled)	None	Low entering fluid temperature in Heating mode
66	10051	Water Exchanger Flow Switch Failure	Manual	Unit shuts down	Flow switch fault
67	10063	Circuit A High Pressure Switch or Elec. box pressure Failure	Manual	Circuit A shuts down	Switch fault
68	10064	Circuit B High Pressure Switch or Elec. box pressure Failure	Manual	Circuit B shuts down	As above
69	10090	Water Exchanger Flow Switch: Setpoint Configuration Failure	Manual	Unit cannot be started	Defective or incorrectly wired flow controller
70	10097	Water Exchanger Temperature Sensors Swapped	Manual	Unit shuts down	Input and output temperature reversed
71	10050	Refrigerant Leakage Detection	Automatic	None	Refrigerant leak or leak detector defective
73	10101	DC Free Cooling Process Failure	Automatic	Dry Cooler Free Cooling is disabled	Fan fault, dirty beam, FC coils are non-purged, failure or incorrect wiring of the FC water temperature sensor
	10102	DC Free Cooling Process Failure	Automatic	Hydraulic Free Cooling is disabled	
74	10220	FC Coils Valve Failure	Automatic	No action (alert)	Valve stuck or connection failure
75	10222	FC Evaporator Valve Failure	Automatic	No action (alert)	Valve stuck or connection failure
76	10223	FC Low Glycol Water Temperature Warning	Automatic (when the temperature of the glycol-water mixture [FC_WGT] is above 1°C OR neither circuit A nor circuit B is operating in FC Mixed mode)	No action (alert)	The temperature of the glycol-water mixture [FC_WGT] is below -5°C and at least one circuit is operating in FC Mixed mode
77	11201	Water Loop : Pressure Too High	Automatic	No action (alert)	For units with the FC option: Water pressure above the maximum output Water Pump pressure (550 kPa)
78	11202	Water Loop : Delta Pressure Error	Automatic, if water pressure delta returns to normal	Unit shuts down	Too low or high water pressure reading
79	11203	Water Loop : Pressure Too Low	Automatic, if water pressure reading returns to normal and the alarm occurred not more than 6 times in the last 24 hours (otherwise manual)	Unit shuts down	Low pump inlet pressure is below 60 kPa
80	11204	Water Loop : Pump Not Started	Automatic	Alarm 10032 (water pump #1 fault) or alarm 10033 (water pump #2 fault) will be triggered	Too low or high water pressure reading
81	11205	Water Loop : Pressure Error During Runtest	Manual	Unit shuts down	Too low or high water pressure reading
82	11206	Water Loop : Pump Overload	Automatic	None	Water loop pressure drop too low
83	11207	Water Loop : Flow Too Low	Automatic, when water flow reading returns to normal	Pump is stopped	Water loop pressure drop too high
84	11208	Water Loop : Pressure Sensors Crossed	Automatic, if water pressure reading returns to normal and the alarm occurred not more than 6 times in the last 24 hours	Unit shuts down	Pressure sensors crossed
85	11209	Water Loop : Low Pressure Warning	Automatic, if water pressure reading returns to normal	None	Evaporator water pressure is below 100 kPa

9 - DIAGNOSTICS

JBus code	Code	Alarm description	Reset type	Action taken	Possible cause
86	10210	Low Delta Pressure Operation Failure - cir A	Automatic (the first 3 alarms in the last 24 hours) or Manual Automatic (if circuit capacity is 0%)	Circuit A shuts down	Circuit running in part load with all available compressors and low delta pressure during operation. Not enough capacity available / failed or disabled due to compressor(s)
87	10211	Low Delta Pressure Operation Failure - cir B	As above	Circuit B shuts down	As above
88	11210	FC Glycol Water Loop : Pressure Too High	Automatic, if pressure reading returns to normal	None	Free Cooling pump pressure is above the maximum pressure threshold (550 kPa by default)
89	11211	FC Glycol Water Loop : Delta Pressure Error	Automatic, if pressure sensor reading returns to normal	Free Cooling is stopped, but the unit continues to run	Loss of calibration
			Manual	Free Cooling is stopped, but the unit continues to run	High water pressure delta reading with the water pump already stopped for 1 minute
90	11212	FC Glycol Water Loop : Pressure Too Low	Automatic, if pressure sensor reading returns to the value above 100 kPa (14.5 PSI) and the alarm occurred up to 6 times in the last 24 hours (otherwise it should be reset manually)	Free Cooling is stopped, but the unit continues to run	Free cooling pump inlet pressure is below 60 kPa (8.7 PSI)
91	11213	FC Glycol Water Loop : Pump Not Started	Manual	Free Cooling disabled	Pump fault
92	11214	FC Glycol Water Loop : Pressure Error During Runttest	Manual	Free Cooling pump is stopped, but the unit continues to run	Too high or low pressure reading
93	11215	FC Glycol Water Loop : Pump Overload	Automatic, when the alarm conditions return to normal	None	Water loop pressure drop too low
94	11216	FC Glycol Water Loop : Flow Too Low	Automatic, if pressure reading returns to normal and the alarm occurred not more than 6 times in the last 24 hours (otherwise manual)	Water pump is stopped, but the unit continues to run	Water flow is below the required threshold
95	11217	FC Glycol Water Loop : Pressure Sensors Crossed	Automatic, if pressure reading returns to normal and the alarm occurred not more than 6 times in the last 24 hours (otherwise manual)	Free Cooling disabled	FC pump is running, but pressure readings are below the required threshold
96	11218	FC Glycol Water Loop : Low Pressure Warning	Automatic, if pressure reading returns to normal	None	Water pressure is below the required threshold

Service and factory

97	70nn	Illegal Factory Configuration Number #1 to nn List of illegal configurations: 01: Unit size unknown (FACTORY_unitsize). 02: Fan type unavailable for the configured unit size. 03: Pump configuration failure. Pump doesn't exist for the configured unit size. 04: This configuration is not available for the unit – unavailable type of refrigerant selected (FACTORY_refrig). Please note that the correct configuration of FACTORY_refrig parameter depends on the software version: • FACTORY_refrig = 1 (R32) for software version 3.0 or lower • FACTORY_refrig = 3 (R32) for software version 4.0 or higher	Automatic, if configuration is corrected	Unit cannot be started	Incorrect unit configuration
98	8000	No Factory Configuration	Automatic, if configuration is provided	Unit cannot be started	No factory configuration

Compressor failure

99	1199	Compressor A1 Failure	Manual	Compressor A1 shuts down	Compressor temperature too high, high pressure switch opened, compressor not started
100	1299	Compressor A2 Failure	Manual	Compressor A2 shuts down	As above

9 - DIAGNOSTICS

JBus code	Code	Alarm description	Reset type	Action taken	Possible cause
101	1399	Compressor A3 Failure	Manual	Compressor A3 shuts down	As above
102	1499	Compressor A4 Failure	Manual	Compressor A4 shuts down	As above
103	2199	Compressor B1 Failure	Manual	Compressor B1 shuts down	As above
104	2299	Compressor B2 Failure	Manual	Compressor B2 shuts down	As above
105	2399	Compressor B3 Failure	Manual	Compressor B3 shuts down	As above
106	2499	Compressor B4 Failure	Manual	Compressor B4 shuts down	As above
107	6001	Circuit A Welded Contactor Failure	Automatic in the case of cooler flow switch failure, high pressure trip or cooler freeze alarm or Manual (power cycle required)	Unit shuts down, but the evaporator pump continues to operate	Welded contactor of a compressor
108	6002	Circuit B Welded Contactor Failure	As above	As above	As above
Software failure					
109	55001	Database Module Failure	Manual	Unit shuts down	Software problem. Contact Service technicians
110	56001	Lenscan Module Failure	Manual	Unit shuts down	Software problem. Contact Service technicians
Service and factory					
111	90nn	Master Chiller Configuration Error Number #1 to nn	Automatic, if master/slave configuration returns to normal or the unit returns to the standalone mode	Master/slave operation is disabled and the unit returns to the stand-alone mode	Configuration failure
Service maintenance warning					
112	13nnn	Service Maintenance Alert Number # nn 004: Maintenance Servicing Required	Manual (or Automatic when the new maintenance date is set)	Depending on the severity of the alarm, the unit may continue to operate or the unit shuts down	Servicing action required. Contact Service technicians
113	13005	Fgas check needed, call your maintenance company	As above	As above	As above
114	13006	Check the concentration of corrosion inhibitor (see IOM)	As above	As above	As above
VFD drive failure					
115	170nn	Circuit A VFD Fan Drive 1 Failure	Automatic or Manual (motor overload)	Units with one drive on the circuit: Circuit A shuts down Units with two drives on the circuit: Circuit A continues to run as long as one of two drives is operating	Speed controller fault (see also section "9.3.2 Drive alarms/alerts")
116	180nn	Circuit A VFD Fan Drive 2 Failure	As above	As above	As above
117	190nn	Circuit B VFD Fan Drive 1 Failure	As above	Units with one drive on the circuit: Circuit B shuts down Units with two drives on the circuit: Circuit B continues to run as long as one of two drives is operating	As above
118	200nn	Circuit B VFD Fan Drive 2 Failure	As above	As above	As above
119	21nnn	VFD Pump 1 Drive Failure	Automatic or Manual	Unit is restarted with another pump running. If no pumps are available, the unit shuts down	As above
120	22nnn	VFD Pump 2 Drive Failure	As above	As above	As above
121	350nn	Circuit A VFD Fan Drive 1 Alert	Automatic	None	As above
122	360nn	Circuit A VFD Fan Drive 2 Alert	Automatic	None	As above
123	370nn	Circuit B VFD Fan Drive 1 Alert	Automatic	None	As above
124	380nn	Circuit B VFD Fan Drive 2 Alert	Automatic	None	As above
125	39nnn	VFD Pump 1 Drive Alert	Automatic	None	As above
126	40nnn	VFD Pump 2 Drive Alert	Automatic	None	As above
SIOB/CIOB board failure					
127	57001	Circuit A SIOB/CIOB Low Voltage Failure	Automatic, if the alarm occurred not more than 6 times in the last 24 hours (otherwise manual)	Unit shuts down	Unstable electrical supply or electrical issue
128	57002	Circuit B SIOB/CIOB Low Voltage Failure	As above	Unit shuts down	As above
129	57006	EMM SIOB/CIOB Low Voltage Failure	As above	Unit shuts down	As above
EXV failure					
130	57020	Main EXV Stepper Motor Failure - Cir A	As above	Circuit A shuts down	EXV motor fault
131	57021	Main EXV Stepper Motor Failure - Cir B	As above	Circuit B shuts down	As above

9 - DIAGNOSTICS

JBus code	Code	Alarm description	Reset type	Action taken	Possible cause
Communication failure					
132	10029	Loss of Communication With System Manager	Automatic, if communication with System Manager is restored	Unit returns to the standalone mode	Communication error
Replacement mode: Software Activation Key(s) missing					
133	10122	Replacement Mode: please contact CIAT service representative to activate options	Automatic, if Software Activation Key is installed Automatic, if Software Activation Key is not provided within 7 days since the first compressor start (the alarm will be reset and software-protected options will be blocked)	Replacement Mode: Please contact CIAT service representative to obtain activation key(s) to retrieve (or activate) software options	CONNECT TOUCH controller was replaced, but Software Activation Key is not installed
Configuration failure					
134	8001	Illegal Brand Identifier	Automatic, if configuration is corrected	Unit not allowed to start	Incorrect unit configuration
Heat Reclaim failure					
135	10052	Heat Reclaim flow switch failure	Automatic, if the alarm occurred not more than 3 times in the last 24 hours (otherwise manual)	No action (alert)	The flow switch has been opened for 5 minutes when the HR pump is running and the 3-way valve opening is exceeding its pre-configured minimum position (the timer can be modified by setting "HR delay flow switch" in HR_CFG table)
136	10128	Heat Reclaim Condenser Freeze Protection	Automatic, if operating conditions return to normal	Heat Recovery mode is stopped, but the chiller continues to operate	HR entering or leaving water temperature is below 1.1°C (applies only to units with "HR condenser fluid" set to "water") The trigger temperature can be modified by setting "HR Min water temp" in HR_CFG table
137	10129	Heat Reclaim high Water Temperature	Automatic, if the alarm occurred not more than 5 times in the last 24 hours (otherwise manual)	Unit shuts down	HR leaving water temperature is above 95°C for 3 minutes
Phase controller failure					
138	10054	3-Phase Control: Fault Detection	Depends on the configuration of the Phase Controller Action (USERCONF, PhCtrAct). For units with PhCtrAct = 0 or 1 (USERCONF): Automatic, if the fault condition is cleared For units with PhCtrAct = 2 (USERCONF): Manual	Depends on the configuration of the Phase Controller Action (USERCONF, PhCtrAct). For units with the alert enabled (USERCONF, PhCtrAct = 0): No action ("alert" only) For units with the alarm enabled (USERCONF, PhCtrAct = 1 or 2): Unit shuts down	The Phase Controller output has opened due to a detected fault: Phase Loss (PL) fault, Phase Sequence (PS) fault, Under Voltage (UV) fault, Over Voltage (OV) fault, Three-Phase Voltage Asymmetry (ASYM) fault, Under Frequency (UF) fault, Over Frequency (OF) fault
Energy Meter failure					
139	59001	Loss of communication with Energy Meter	Automatic, if communication is re-established	No action (alert)	Bus installation fault, Energy Meter fault, communication error

NOTE: When the "action taken" given in the table above is defined as "none", it means that the alarm message is displayed, but no action is taken on the unit.

9 - DIAGNOSTICS

9.3.2 Drive alarms/alerts

Fan drive alarms or alerts are displayed based on the following formulas:

- 17-YYY to 19-YYY (17=A1, 18=A2, and 19=B1, 20=B2) for alarms (YYY stands for the alarm code).
- 35-YYY to 38-YYY (35=A1, 36=A2, 37=B1, 38=B2) for alerts (YYY stands for the alert code).

Pump drive alarms are displayed as follows:

- 21-YYY for pump 1 and 22-YYY for pump 2 (YYY stands for the alarm code).

Pump drive alerts are displayed as follows:

- 39-YYY for pump 1 and 40-YYY for pump 2 (YYY stands for the alert code).

Code	Description	Code	Action to be taken
Drive alarms			
0	No error	NErr	Contact Service if more information is needed
1	Over-current during acceleration	OC1	As above
2	Over-current during deceleration	OC2	As above
3	Over-current during constant speed operation	OC3	As above
4	Over-current in load at startup	OCL	As above
5	Short circuit in arm	OCA	As above
8	Input phase failure	EPHI	As above
9	Output phase failure	EPHO	As above
10	Overvoltage during acceleration	OP1	As above
11	Overvoltage during deceleration	OP2	As above
12	Overvoltage during constant speed operation	OP3	As above
13	Over-LOAD in inverter	OL1	As above
14	Over-LOAD in motor	OL2	As above
16	Overheat trip	OH	As above
17	Emergency stop	E	As above
18	EEPROM fault 1 (writing operation)	EEP1	As above
19	EEPROM fault 2 (reading operation)	EEP2	As above
20	EEPROM fault 3 (other)	EEP3	As above
-	Speed ref alarm	Err1	As above
21	RAM fault	Err2	As above
22	ROM fault	Err3	As above
23	CPU fault	Err4	As above
24	Communication error trip	Err5	As above
26	Current detector fault	Err7	As above
27	Optional circuit board type error	Err8	As above
28	Graphic keypad communication error	Err9	As above
29	Small-current trip	UC	As above
30	Trip due to under voltage in main circuit	UP1	As above
32	Over-torque trip	Ot	As above
34	Ground fault trip (hardware detection)	EF2	As above
37	Overcurrent flowing in element during acceleration	OC1P	As above
38	Overcurrent flowing in element during deceleration	OC2P	As above
39	Overcurrent flowing in element during operation	OC3P	As above
41	Inverter type error	EtYP	As above
46	External thermal input	OH2	As above
47	VIA cable break	SOUt	As above
50	Break in an analogue signal cable	E-18	As above
51	CPU fault	E-19	As above
52	Excess torque boost	E-20	As above
53	CPU fault	E-21	As above
84	Auto-tuning error	Etn1	As above
72	Closed damper 1 fault	Fd1	As above
73	Closed damper 2 fault	Fd2	As above
-	Download transfer fault	CFI2	As above

9 - DIAGNOSTICS

Code	Description	Code	Action to be taken
Drive alerts			
1	Overcurrent	-	Contact Service if more information is needed
2	Drive overload	-	As above
3	Motor overload	-	As above
4	Overheat	-	As above
5	Overvoltage	-	As above
6	Main circuit undervoltage	-	As above
7	Reserved	-	As above
8	Undercurrent	-	As above
9	Over-torque	-	As above
10	Reserved	-	As above
11	Cumulative operation hours reached	-	As above
12	Reserved	-	As above
13	Reserved	-	As above
14	Main circuit undervoltage alarm the same as MS-relay status	-	As above
15	At the time of the instant blackout, Forced deceleration/stop	-	As above
16	An automatic stop during the lower limit frequency continuance	-	As above
17	PTC thermistor alarm	-	As above
22	Overload alarm	-	As above
23	Underload alarm	-	As above

* Error 24 and 104 possible

** Error 50 to 58 possible

*** Error 70 or 250 possible

10 - MAINTENANCE

In order to ensure the optimal operation of the equipment as well as the optimization of all the available functionalities, it is recommended to activate a Maintenance Contract with your local Service Agency.

The contract will ensure your equipment is regularly inspected by specialists so that any malfunction is detected and corrected quickly and no serious damage can occur to your equipment.

Your local Service Agency provides a wide range of service contracts which embrace the assistance of highly qualified HVAC engineering professionals ready to help if needed. The Maintenance contracts represent not only the best way to ensure the maximum operating life of your equipment, but also, through the expertise of qualified personnel, the optimal tool to manage your system in a cost-effective manner.

To find the best type of contract that will meet all of your expectations, please contact your local Manufacturer representatives.

11 - APPENDIX 1: SMART GRID READY INSTALLATION INSTRUCTIONS

11.1 Introduction

The increase in renewable electricity generation is leading more and more to load fluctuations. These fluctuations can be intelligently compensated by smart grid systems which combined with heat pumps allow an efficient use of energy. Electrical energy can be converted into thermal energy (heat) and the heat can be stored with the use of a water tank.

The Smart Grid Ready ("SG Ready") label of the heat pump allows the energy supplier to access the heat pump and manage its four energy usage control states. These states are activated through two inputs (SGR0_BST and SGR1_LCK).

The Smart Grid Ready label is valid only in the DACH region (Germany, Austria, Switzerland).

This document contains information about four "energy usage" control states supported by the heat pump and gives instructions on how the system should be configured by an installer.

It is strongly recommended to read the whole document prior to starting any installation or maintenance procedures. Please note that screenshots provided in this manual are solely for the purpose of illustration and they may differ from the actual look.

The Smart Grid Ready functionality (option 157D) is not provided as standard. Please contact the Manufacturer to purchase this option.

For Aquaciat Power ILD 602R-2650R, the SG Ready option requires:

- an additional I/O board (A156 board)
- factory configuration

11.2 Configuration of Smart Grid Ready option

The Smart Grid Ready option can be configured on the local touch screen.

11.2.1 Enable SG Ready option

Only logged-in users can enable the SG Ready option. The factory access mode is required.

To log in as a factory user

1. Tap  to open the Login menu.

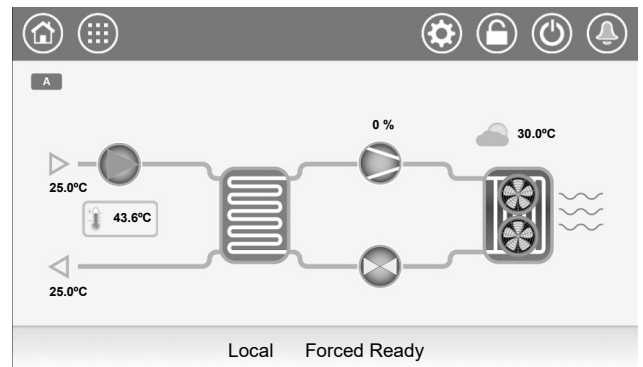

2. In the Login menu, select "Factory Login" .

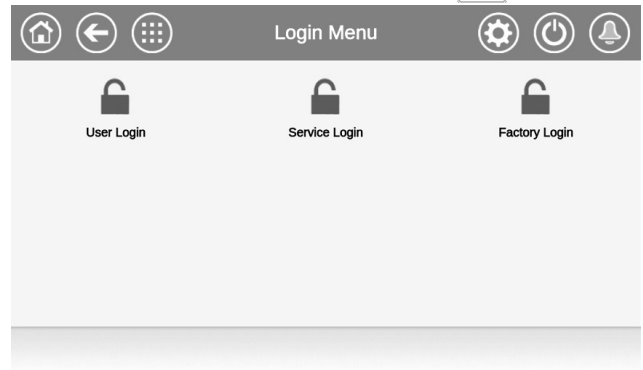

3. Tap the password field.



4. Enter and confirm your password.





5. Tap  to save changes.

11 - APPENDIX 1: SMART GRID READY INSTALLATION INSTRUCTIONS

To enable the Smart Grid Ready option

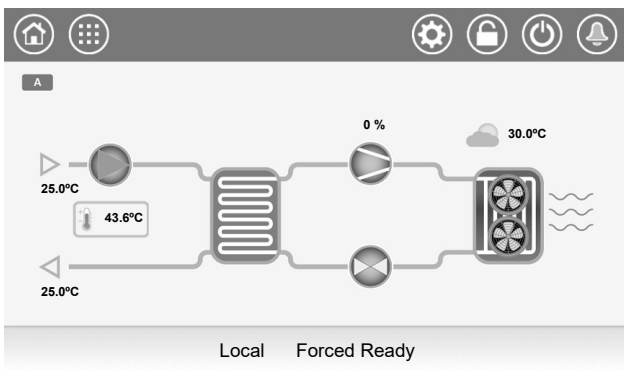
1. Tap  to open the Main Menu.



2. Select "Configuration Menu" .

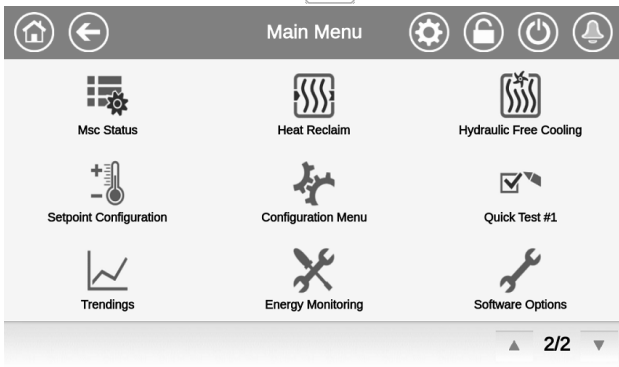

3. Select "Factory Configuration" .

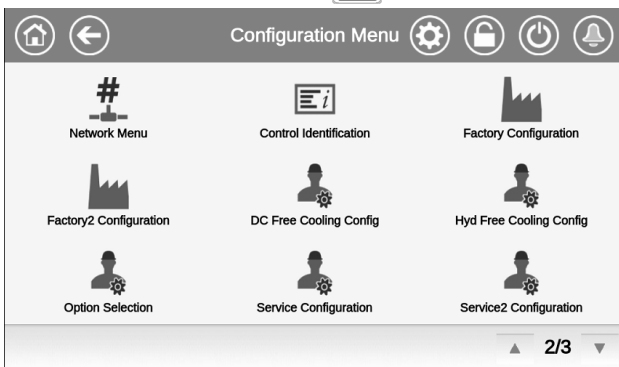

4. The Factory Configuration menu will be displayed.

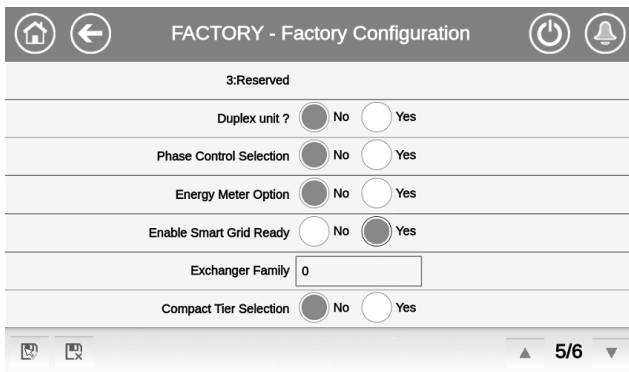

5. In this view, find "Enable Smart Grid Ready" and set the parameter to "enable" to activate the Smart Grid Ready option.
6. Save changes.

11.2.2 Smart Grid Ready inputs

Two digital inputs (SGR0_BST and SGR1_LCK) are used to allow the energy supplier to control the heat pump and enhance load management.

After wiring these two digital inputs (SGR0_BST and SGR1_LCK) to the energy supplier module and enabling the "SG Ready" option, the Smart Grid Ready option offers four energy control modes (1 = LOCK, 2 = NORMAL, 3 = BOOST, 4 = FORCED).

The status of Smart Grid inputs can be verified in the Inputs menu on the local touch screen.

To verify the status of Smart Grid inputs

1. Tap  to open the Main Menu.

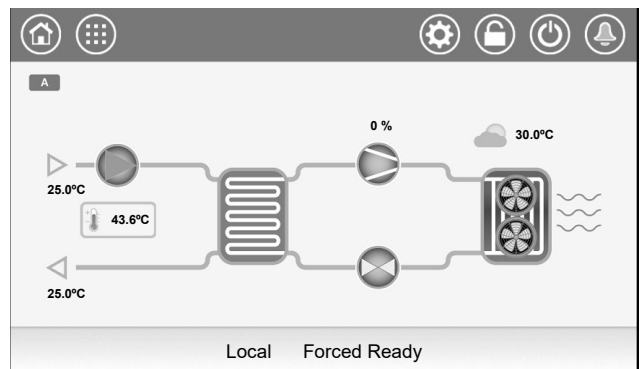

2. Select "Inputs" .

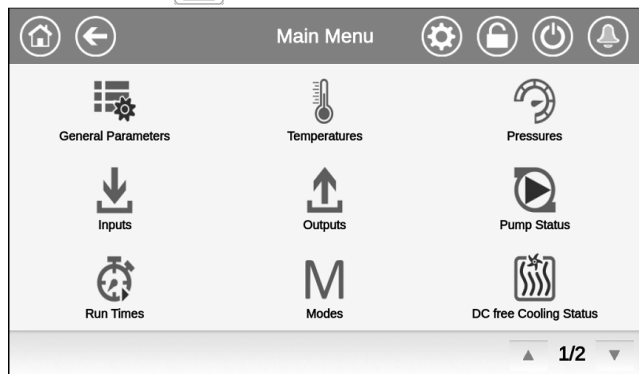

3. The Inputs menu will be displayed.

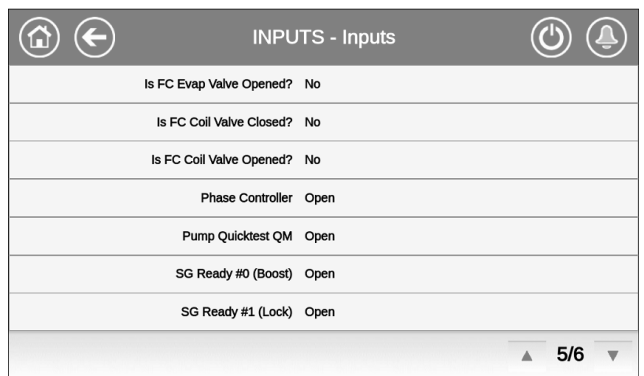

4. In this view, find "SG Ready #0 (Boost)" and "SG Ready #1 (Lock)" to verify the status of Smart Grid Ready Inputs.
 - SG Ready #0 (Boost): open/closed.
 - SG Ready #1 (Lock): open/closed.

11 - APPENDIX 1: SMART GRID READY INSTALLATION INSTRUCTIONS

11.3 Smart Grid Ready operating modes

For heat pumps with Smart Grid enabled, there are four control states ("energy control modes") available.

The active mode depends on SGR1_LCK and SGR0_BST signals:

State	Name	SGR0_BST	SGR1_LCK
1	LOCK	0	1
2	NORMAL	0	0
3	BOOST	1	0
4	FORCED	1	1

Smart Grid operating modes:

- Lockout state (1 = LOCK):** In this mode, the heat pump occupancy is turned off in order to stop the heat pump. If configured, the boiler output is turned on. The buffer tank will be used to provide heating demand. See also section 11.3.2.
 - The energy supplier can block the operations of the heat pump (activate the LOCK mode) for a maximum of 6 hours a day. One lockout may last 2 hours maximum and there must be at least a two-hour interval between two lockouts. For example, if the lockout starts at 10:00 and ends at 12:00, then the next lockout cannot be activated until 14:00.
- Normal operating state (2 = NORMAL):** In this mode, the heat pump runs in energy-efficient normal mode with proportional heat storage.
- Low current surplus state (3 = BOOST):** In this mode, the energy supplier allows the heat pump to run at its maximum capacity. The heat pump is requested to use the surplus energy to reach the maximum possible temperatures for heating and warm water. A user-defined offset is applied to the desired temperature setpoint (see section 11.3.3).
 - This is not a definite start-up command, but a switch-on recommendation based on the boost in energy supply.
- High current surplus state (4 = FORCED):** In this mode, the heat pump is forced to run at its maximum capacity. A user-defined offset is applied to the desired temperature setpoint (see section 11.3.3).

The heat pump occupancy is turned on independently of any schedule program. This can be for the buffer tank, room heating or domestic hot water production.

 - The heat pump will run in this mode for an undetermined period of time (until the FORCED mode is deactivated).

11.3.1 Smart Grid status

The Smart Grid Status can be found in the General Parameters menu (GENUNIT) or at the bottom of the touch screen.

To check the Smart Grid mode or change Heat/Cool mode

- Tap  to open the Main Menu.
 - The Smart Grid mode is displayed at the bottom bar on the touch screen ("Forced Ready").

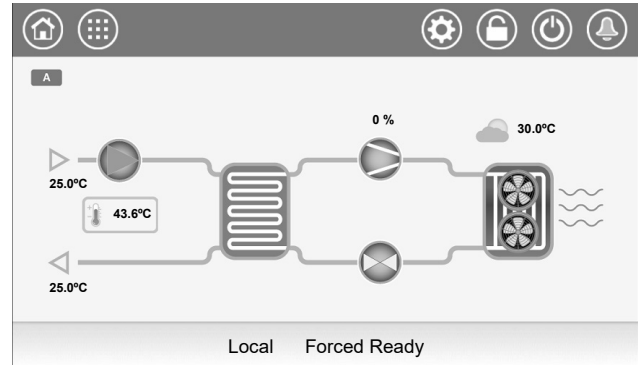

- Select "General Parameters" .

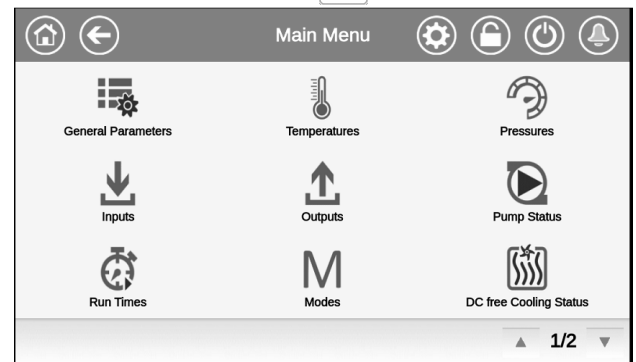

- The General Parameters menu will be displayed.
 - In this view, find "Smart Grid Ready Status".
 - 1 = LOCK
 - 2 = NORMAL
 - 3 = BOOST
 - 4 = FORCED

GENUNIT - General Parameters	
Outdoor Air Temp	-17.8 °C
Emergency Stop	Disable
Active Demand Limit Val	100 %
Lag Capacity Limit Value	100 %
Active FC Dem Lim Val	100 %
Lag FC Cap Limit Value	100 %
Smart Grid Ready Status	2

Note: "Heat/Cool Select" allows you to set the unit in Heating or Cooling mode.

11 - APPENDIX 1: SMART GRID READY INSTALLATION INSTRUCTIONS

11.3.2 LOCK operating mode

In the LOCK mode, the heat pump is in the OFF state.

For units with a boiler, the boiler can be started during the lock state only when "SGR Threshold" setting allows.

To start the boiler, the Outside Air Temperature (OAT) must be below the SGR Boiler OAT Threshold which is defined by the user.

To change the SGR boiler threshold

1. Tap  to open the Main Menu.

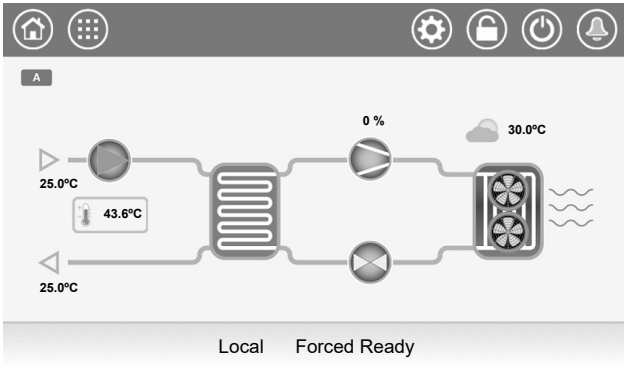

2. Go to "Configuration"  > "Backup Configuration" .

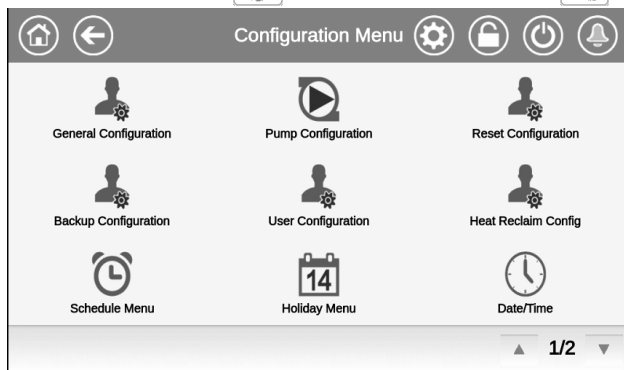

3. The Backup Configuration menu will be displayed.

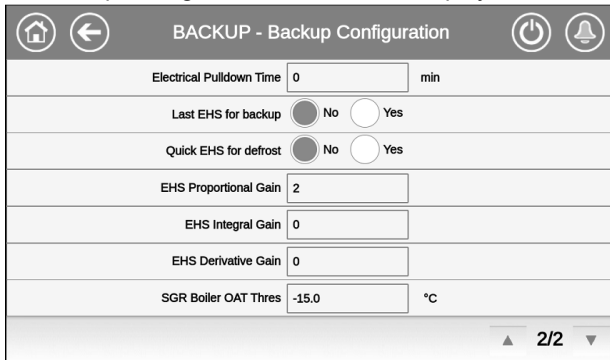

4. Set the Smart Grid threshold to start the boiler.
 - The threshold ("SGR Boiler OAT Thres") is -15°C by default.

11.3.3 BOOST/FORCED operating mode

In the BOOST/FORCED mode, it is possible to define an offset used to adjust the water temperature setpoint.

To set the Smart Grid offset

1. Tap  to open the Main Menu.

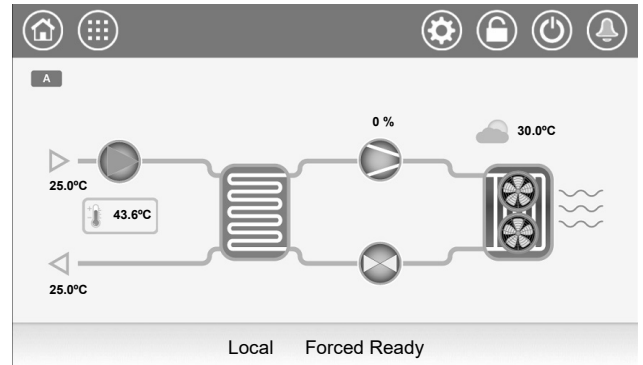

2. Go to "Configuration"  > "Reset Configuration" .

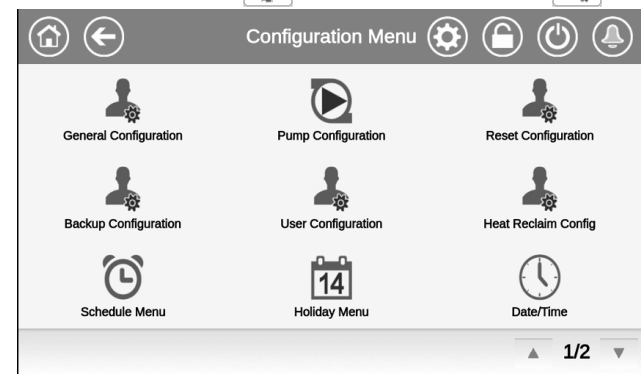

3. The Reset Configuration menu will be displayed.
 - In this view, find "Smart Grid Ready Option".

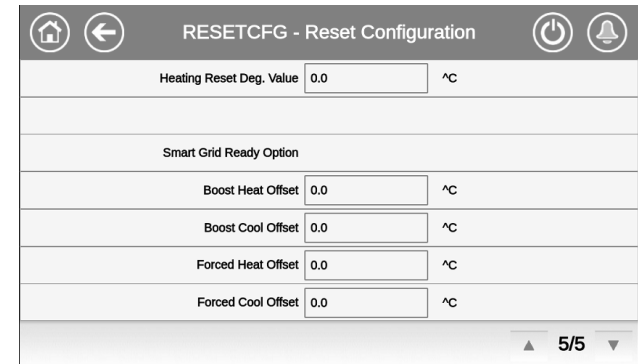

4. Set the Smart Grid offset value for Heating or Cooling mode.
 - "Boost Heat Offset" (0°C by default).
 - "Boost Cool Offset" (0°C by default).
 - "Forced Heat Offset" (0°C by default).
 - "Forced Cool Offset" (0°C by default).

11 - APPENDIX 1: SMART GRID READY INSTALLATION INSTRUCTIONS

11.4 Wiring: Smart Grid connections

The Smart Grid Ready module must be connected to "LIM_SW1" and "LIM_SW2" inputs. These contacts are used to limit heat pump capacity and the capacity limit setpoint (lim_sp) applied to the unit depends on the status of these contacts.

- LIM_SW1 and SGR0_BST are wired to DI-03 on A1A board.
- LIM_SW2 and SGR1_LCK are wired to DI-02 on A156 board.

By default, "lim_sp1" and "lim_sp3" are equal to 100%, but they can be set to other values to limit the unit capacity. When the SG Ready option is enabled, these limits are applicable in "Boost" and "Forced" operating modes.

11.5 Electrical diagram

SG Ready module must be wired to DI-03 on A1A I/O board and DI-02 on A156 I/O board.

The Smart Grid Ready option is available only for units equipped with the optional Energy Management Module.

Smart Grid status	1 = LOCK	2 = NORMAL	3 = BOOST	4 = FORCED
Capacity Limit	lim_sp2*	100%	lim_sp1	lim_sp3
SGR0_BST	open	open	close	close
SGR1_LCK	close	open	open	close

*Lim_sp2 becomes not applicable in the LOCK operating mode.

Customer control connections: A1A board

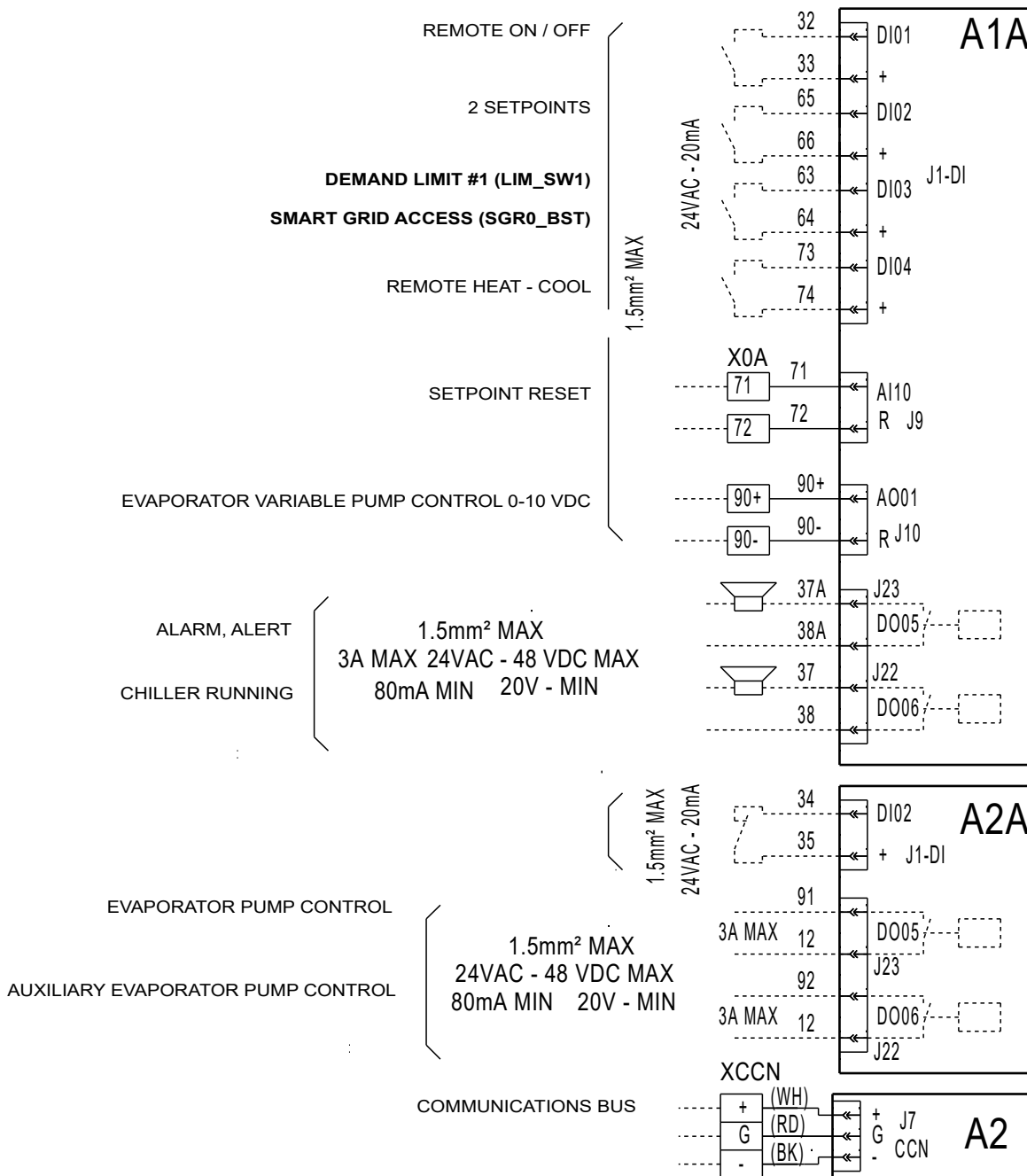

11 - APPENDIX 1: SMART GRID READY INSTALLATION INSTRUCTIONS

Customer control connections: A156 board (optional)

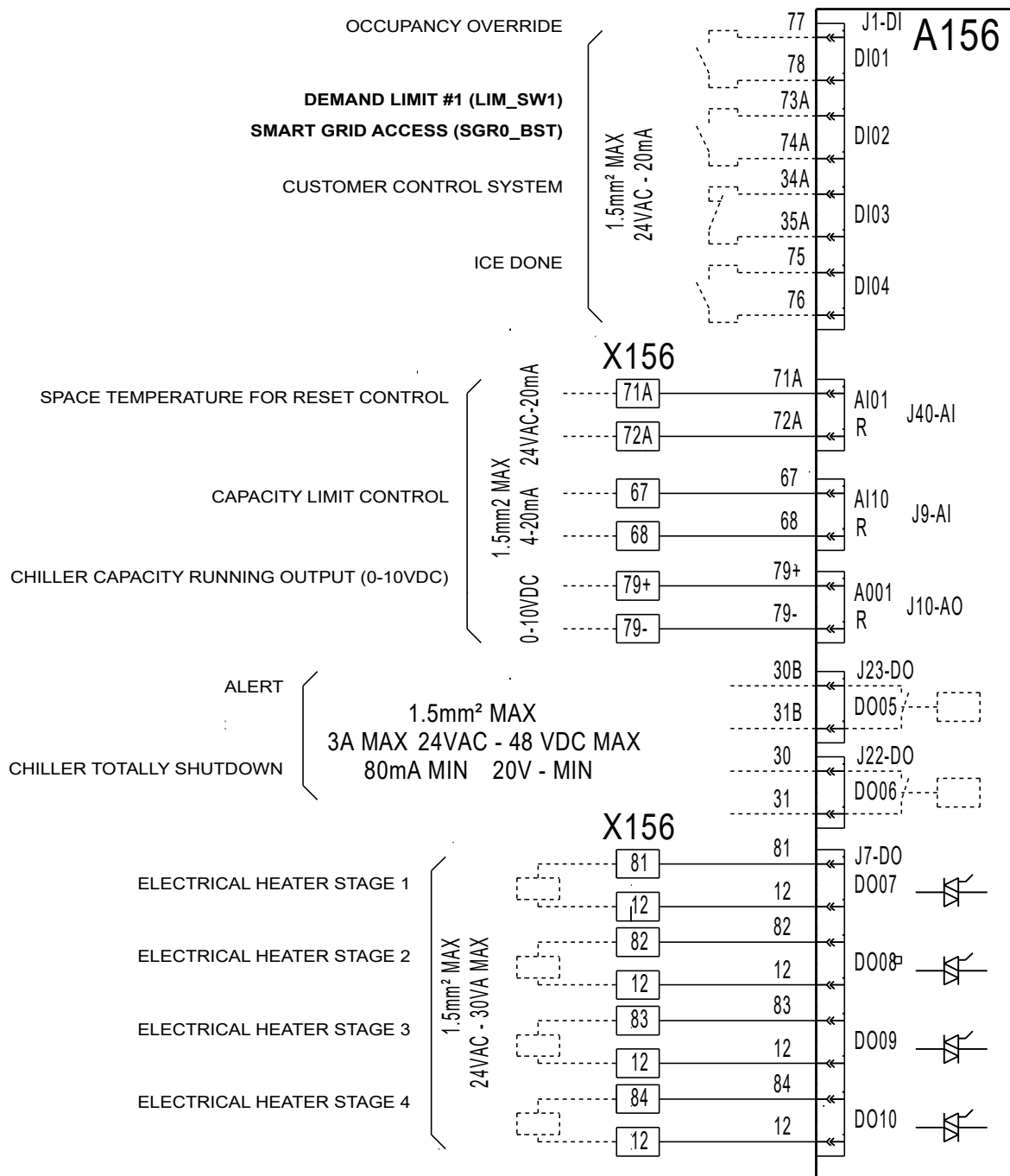

NOTE: A156 is an optional board (provided with the Energy Management Module).

11 - APPENDIX 1: SMART GRID READY INSTALLATION INSTRUCTIONS

11.6 Electrical box: Location

The terminal access for Smart Grid Inputs is located inside the electrical box of the heat pump (A1A board and A156 board).

Component arrangement: Control box

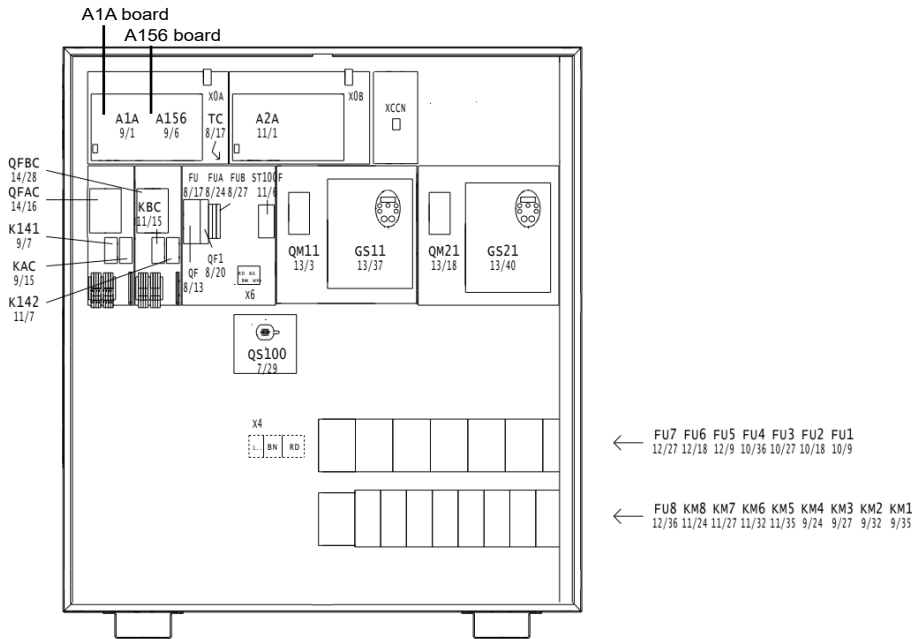

NOTE: The number of electrical components available on the board may differ depending on the size of the unit.

Smart Grid connections: A1A board

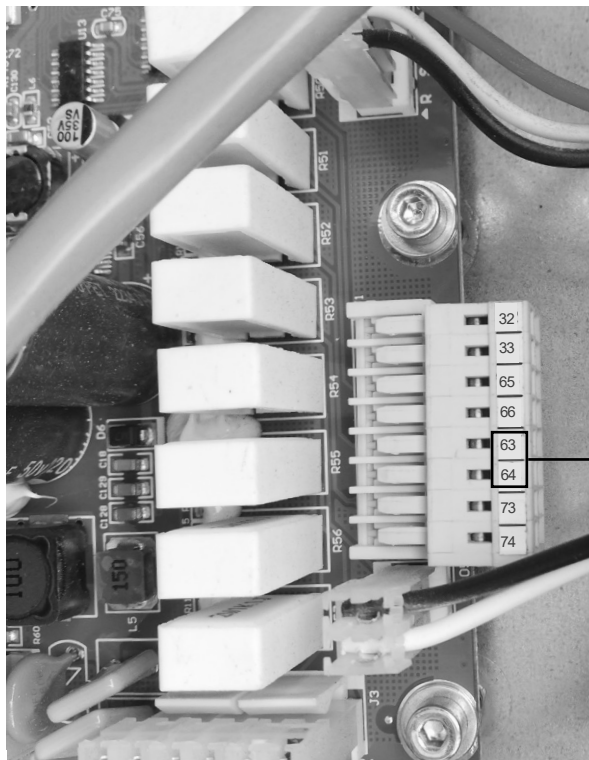

SMART GRID ACCESS (SGR0_BST)

Smart Grid connections: A156 board (optional)

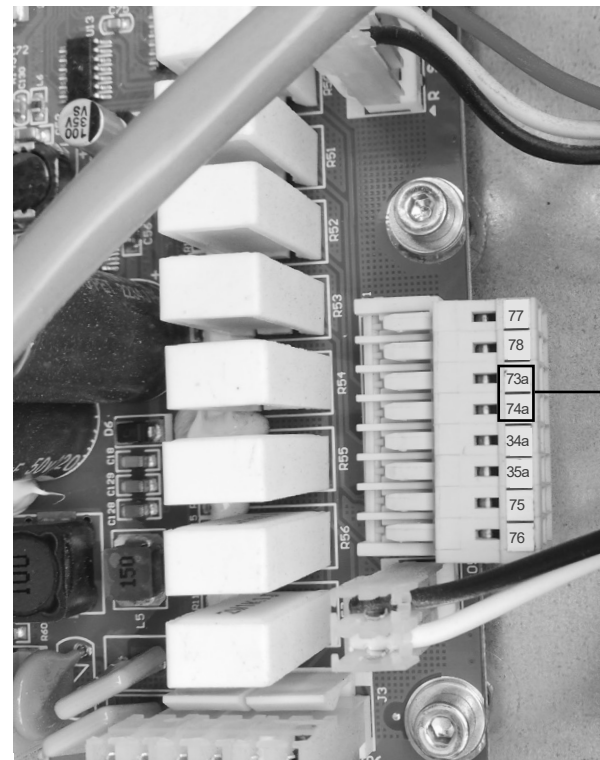

SMART GRID ACCESS (SGR1_LCK)

NOTE: A156 is an optional board (provided with the Energy Management Module).

The quality management system of this product's assembly site has been certified in accordance with the requirements of the ISO 9001 standard (latest current version) after an assessment conducted by an authorized independent third party.

The environmental management system of this product's assembly site has been certified in accordance with the requirements of the ISO 14001 standard (latest current version) after an assessment conducted by an authorized independent third party.

The occupational health and safety management system of this product's assembly site has been certified in accordance with the requirements of the ISO 45001 standard (latest current version) after an assessment conducted by an authorized independent third party.

Please contact your sales representative for more information.

Carrier SCS, Montluel, France.

Manufacturer reserves the right to change any product specifications without notice.

Printed in the European Union.